

1131s
mm.160x32

Cod. CI0S1131 xxx00

Disponibile in 10 finiture. Vedi aletta di copertina.
Available in 10 finishes. Please see the inside cover flap.
Disponibile in 10 acabados. Ver en la solapa.

Pack. 3

Cerniere invisibili regolabili per porte
Invisible adjustable hinges for doors
Bisagras invisibles ajustables para puertas

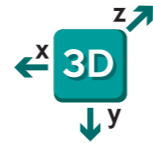

MAINTENANCEFREE

CARATTERISTICHE:

- Realizzata in zama in 10 diverse finiture
- Ideale per ante con spessore minimo di 38 mm
- Lunghezza totale 160 mm
- Profondità solo 29 mm
- Regolazione tridimensionale S.T.A.R.S.
- Portata fino a 120 kg
- Easy installation e simmetria di cava
- Rivista in estetica e funzionalità: più elegante e resistente all'ossidazione grazie alla nuova cassa esterna in zama zincata. Snodo evoluto per una migliore performance: movimento più fluido, deciso, durevole e ora certificato per porte fino a 1000 mm di larghezza

MAIN FEATURES:

- Manufactured in zamak in 10 different finishes
- Suitable for doors of 38 mm min. thickness
- Total length 160 mm
- Depth 29 mm
- 3D adjusting system S.T.A.R.S.
- Load capacity up to 120 kg
- Easy installation and slot symmetry
- Revised in aesthetics and operation: now more elegant and resistant to oxidation due to the new external case in zincked zamak. Joint evolved for better performance: smoother movement, extremely precise, durable and now certified for doors up to 1000 mm wide

CARACTERÍSTICAS:

- Fabricada en zamak en 10 acabados diferentes
- Adapta para puertas con un espesor mínimo de 38 mm
- Longitud total 160 mm
- Profundidad de solamente 29 mm
- Ajuste en 3D S.T.A.R.S.
- Capacidad de carga hasta 120 kg
- Easy installation y simetría de corte
- Revisada en estética y funcionalidad: ahora más elegante y resistente a la oxidación gracias a la nueva carcasa exterior en zamak cincado. Mecanismo evolucionado para un mejor rendimiento: movimiento más fluido, determinado, duradero y ahora certificada para puertas de hasta 1000 mm de ancho

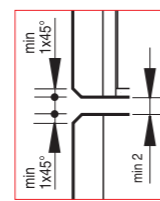
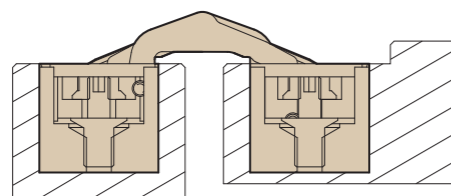
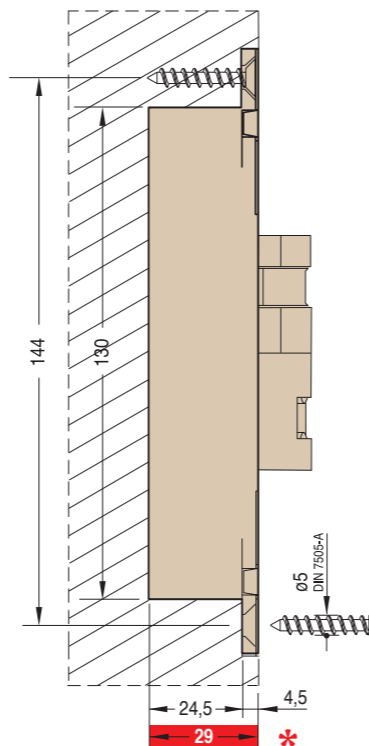
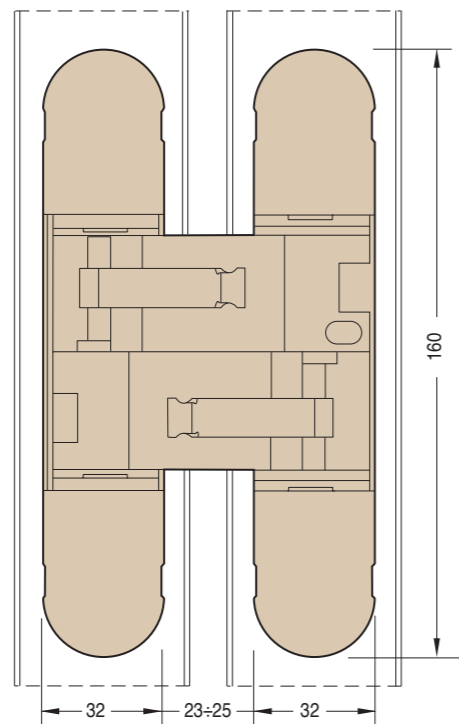
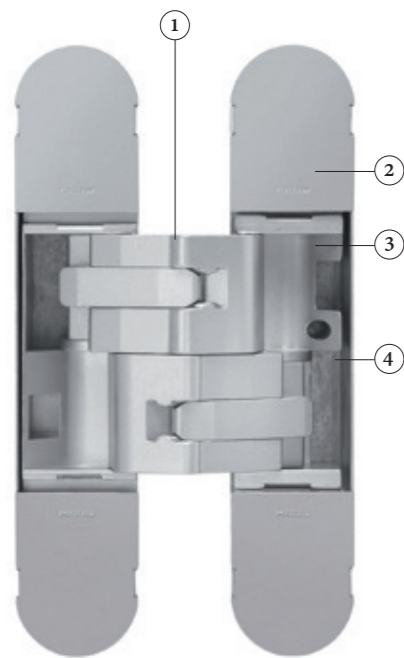

* Profondità di cava contenuta - Small drilling depth - Baja profundidad de corte

- 1 Snodo realizzato in Zama
Mechanism manufactured in zinc-alloy
Mecanizado fabricado en zamak
- 2 Covers in acciaio galvanizzato
Galvanized steel covers
Cover en acero galvanizado
- 3 Gabbia interna in Zama
Zinc-alloy internal body
Caja interna en zamak
- 4 Gabbia esterna in Zama
Zinc-alloy external body
Caja esterna en zamak

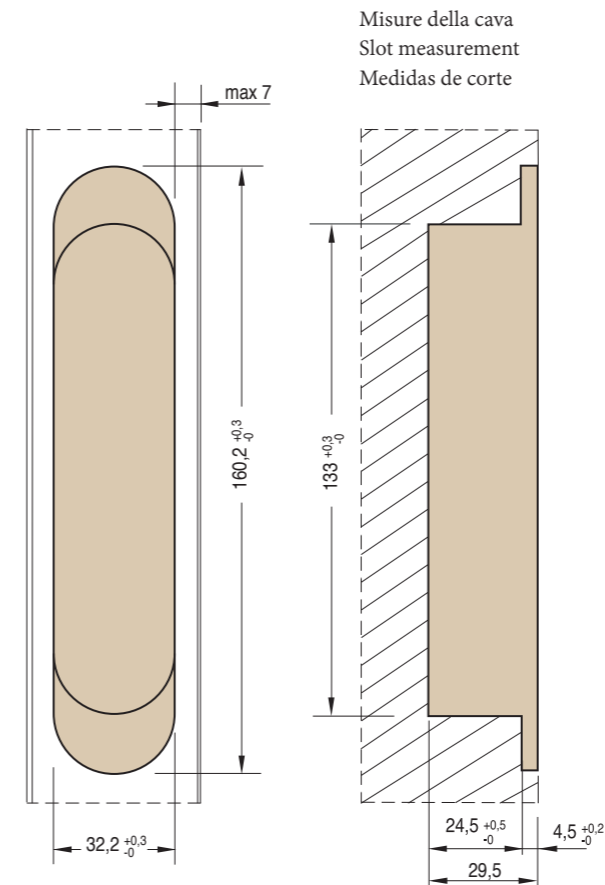

Misure della cava
Slot measurement
Medidas de corte

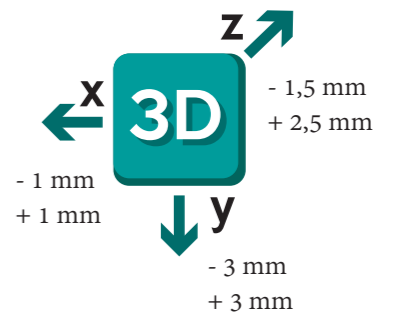

REVERSIBILITÀ - REVERSIBILITY - REVERSIBILIDAD

Reversible per porte da 38 mm a 46 mm di spessore
Reversible for doors from 38 mm to 46 mm thick
Reversible para puertas de 38 mm hasta 46 mm de espesor

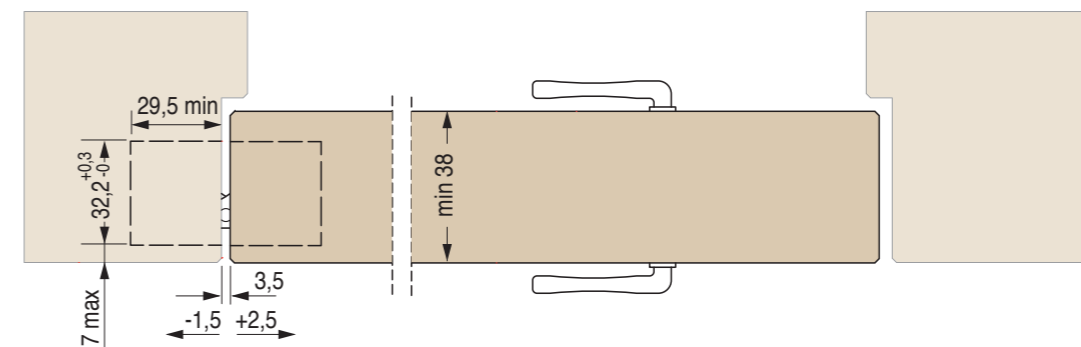
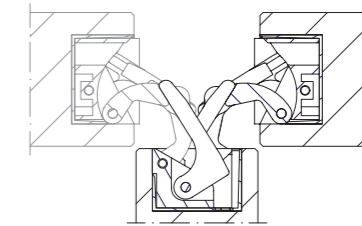

Sezione porta
Door cross-section
Sección de puerta

**SCHEMA DI PORTATA
LOAD CAPACITY CHART
TABLA DE CAPACIDAD DE CARGA**

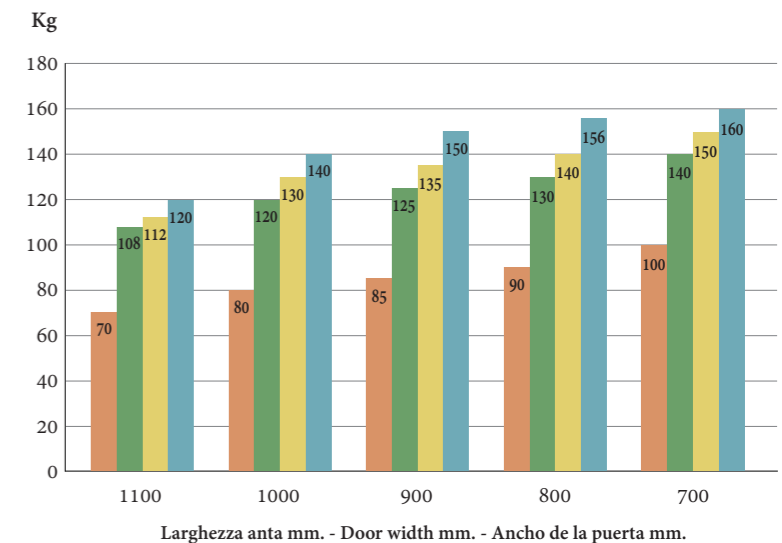
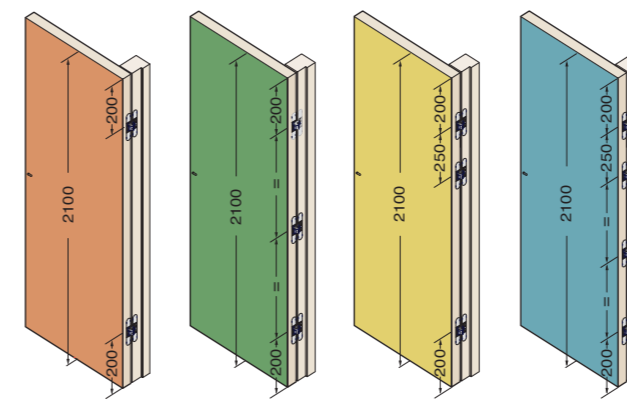

- 2 Cerniere - 2 hinges - 2 bisagras
- 3 Cerniere simmetriche - 3 symmetrical hinges - 3 bisagras simetricas
- 3 Cerniere asimmetriche - 3 asymmetrical hinges - 3 bisagras asimetricas
- 4 Cerniere - 4 hinges - 4 bisagras

Altezza porta 2100mm; per H. > 2100 o per utilizzi con chiudiporta, consultare pag.92
Door Height 2100mm; for H>2100 or for doorclosers devices please see pag.93
Altura puerta 2100mm; para H>2100 o para usos con cierrapuertas, consultar pag.94

Linee guida di regolazione

Adjustment guidelines
Guía general de ajuste

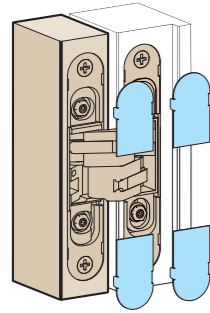

- 1131s
- 1230s
- 1130s
- 1129
- 1030 inox
- 1330s
- 1235s
- 1329
- 1229

Cerniere invisibili regolabili per porte
Invisible adjustable hinges for doors
Bisagras invisibles ajustables para puertas

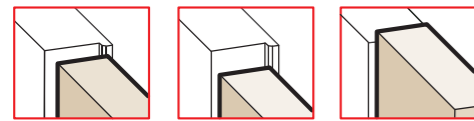
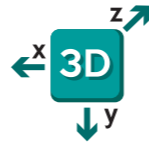

Regolazione verticale
Vertical adjustment
Ajuste vertical

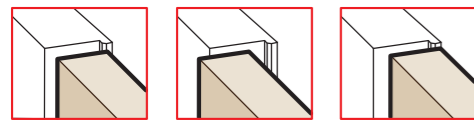
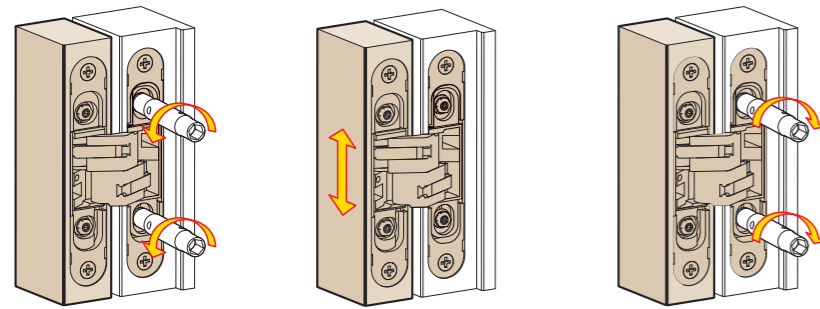
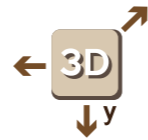

Regolazione orizzontale
Horizontal adjustment
Ajuste horizontal

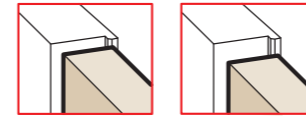
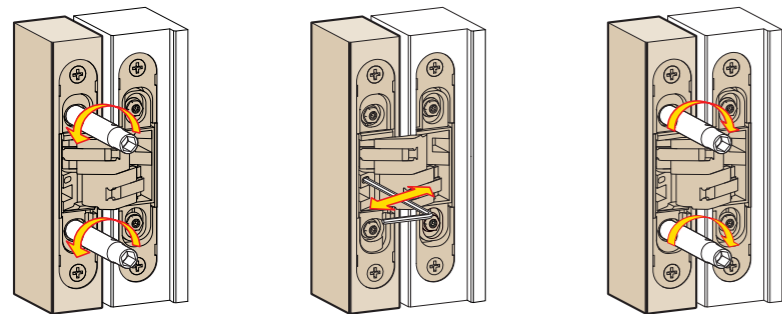
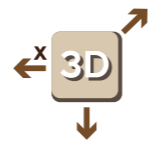

Regolazione in profondità
Depth adjustment
Ajuste de profundidad

