

Specifications Elan 30S

Elan Heated Towel Ladder

Model: 30S - Square

Code: ELA-8A02 (dual wiring)

Measurements

600W x 550H x 90Dmm

Width Centres 575mm

Vertical Centres 370mm

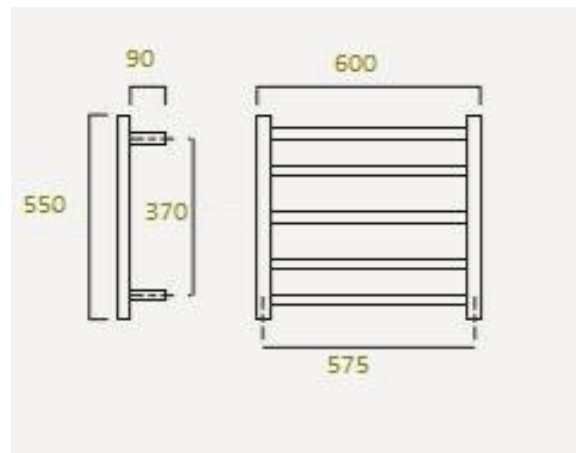

Features

5 Rails

High Mirror Polish

Quality Stainless Steel

Dual Wiring

Concealed or Exposed Wiring

Electrical Specifications

230-240v Volts ac, 50Hz

55 Watts

IP Rating 55

Complies to Standards

AS/NZS 60335.1.2012