

1. Lock case.
2. Back plate-  
bolt is packed separately
3. Neoprene seals x2
4. Spindles  
(Only one is used).
5. Mortice keeper
6. Surface keeper
7. Wood screws x2  
(to use with keeper)
8. Tweezers
9. Fixing bolts  
3 supplied (spare x1)
10. Tumblers (spare x2)
11. Code card

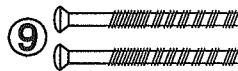

- Tools required for installation
- Power drill
  - 8mm & 13mm drill bits
  - Bradawl
  - Philips screw driver size 2
  - Chisel (maximum 15mm)
  - Hammer/Mallet
  - Stanley knife
  - Pencil
  - Tape measure

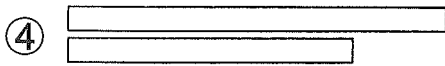
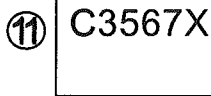
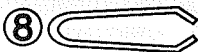
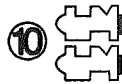
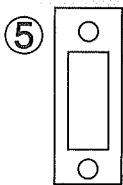

## SPECIAL NOTES

Before commencing installation check that all parts are working correctly. Press the code according to the code card and the knob should then turn, in either direction, once only, and return easily under spring pressure. From inside the door the bolt can be freely locked and unlocked using the knob. From outside the code is required both to lock and to unlock the bolt. If you would like to be able to LOCK your door from outside WITHOUT using the code then follow instruction 2.

- If you intend to change the code then, if it is convenient, you should do it before installing the lock. See the code change instructions in the separate leaflet.
- Note that the lock is supplied as standard with a bolt which projects 40mm from the side of the lock. A shorter bolt which projects 20mm is available.

## 1 CHECK THE HAND OF YOUR DOOR

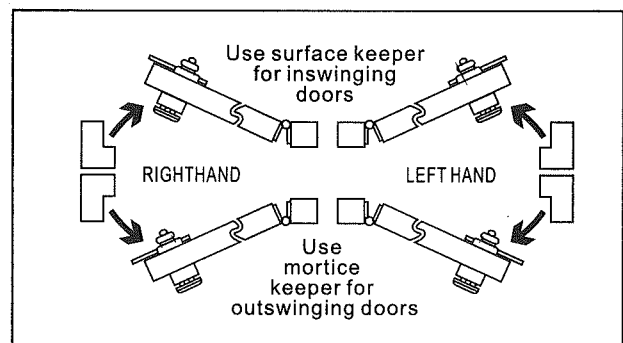

- Your door is right-handed if, viewed from outside, the hinges are on the right.

## 2 OUTSIDE KNOB LOCKING ACTION

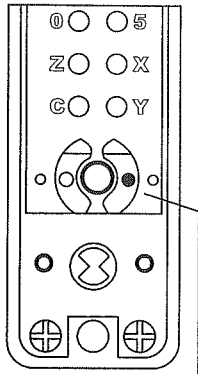

Leave this pin  
for left handed doors

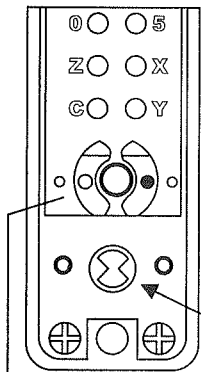

Leave this pin  
for right handed doors

To enable **LOCKING** of the bolt from outside **WITHOUT** using the code:

- Press the C button to reset the chamber and place the lock case on a flat surface with the buttons down.
  - Remove the code chamber plate held in place with the two red screws.
  - With the tweezers remove the right-hand pin for right-handed doors, or the left-hand pin for left-handed doors.
  - Replace the cover plate.
  - The outside knob will now feel loose and turn freely in one direction, and will require the code to be used before it will turn in the other direction.
- NB When installing the lock make sure that the driver is in the correct position before installing the spindle.

## 3 POSITIONING THE LOCK

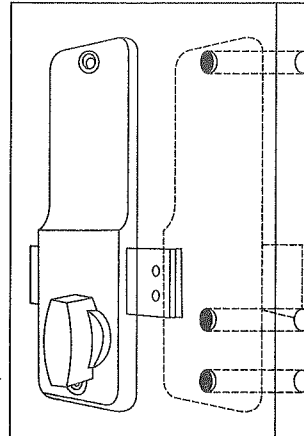

Note:  
Establish which keeper to use, and mark its position on the frame, before proceeding to drill the door for the lock (see step 5).

- Remove the inside cover plate from the back plate, and install the deadbolt according to the hand of your door. Note that the standard bolt projects 40mm to the locking side. A shorter bolt which projects 20mm is available.
- Set the back plate with the knob in the vertical position and hold it to the door with one end of the bolt against the frame where the keeper will be fitted (see step 5).
- Mark the position of the top fixing hole, and then using one of the packing pieces as a template mark the position of the lower fixing hole and the hole for the spindle. Drill 8mm holes for fixing bolts and 13mm hole for spindle.

## 4 FIXING THE LOCK

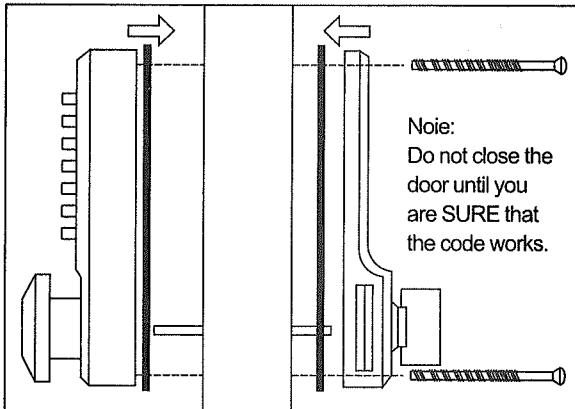

Noie:  
Do not close the door until you are **SURE** that the code works.

- The spring loaded spindle will fit doors between 35mm and 65mm thick, For doors less than 50mm thick break off the 15mm section at the end of the spindle For doors more than 65mm thick ring the helpline for advice. The spring keeps the spindle firmly engaged in the outside handle when the lock is assembled on the door.
- Cut the fixing bolts to suit the door thickness, allowing for the rubber seals and at least one threaded section to screw into the lock case.  
Note that the bottom fixing bolt will be longer than the top
- Hold the lock case and the back plate, with the neoprene seals in place, onto the door with the spindle in position Using the top fixing bolt first screw everything together.

## 5 FITTING THE KEEPER

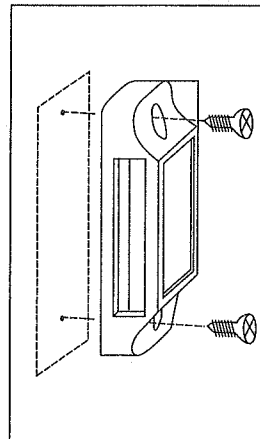

Surface Keeper  
fig. 5.1

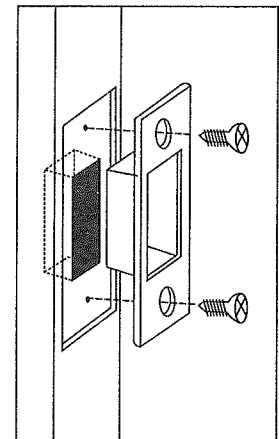

Mortice Keeper  
fig. 5.2

- First select the appropriate keeper for your frame.
- Position the keeper on the frame so that it lines up with the deadbolt and mark the appropriate holes.
- If you are using the Surface Keeper simply screw into place (see fig. 5.1). Use the packing pieces as required.
- The Mortice Keeper will require cutting a small recess (see fig. 5.2).

## 7 REMOVAL OF THE SNIB FUNCTION (For 2200 only)

"If the snib function is not required, you can remove it by unscrewing the 4 screws, one from each corner, (2 long & 2 short ) from inside the backplate. This will enable the metal plate, the snib, a small spring & a ball bearing to be removed. Please note that the metal plate, only needs to be replaced plus the enclosed plastic clip to cover the aperture."

### HOW TO CHANGE YOUR CODE NUMBER

- 1) Remove the lock from the door.
- 2) Remove the 4 retaining screws from the back of the 'Outside lock body'. Take EXTRA care to keep the lock body on a flat surface, when you are removing the plate, because there are a lot of small components inside.
- 3) You will now see that there are 5 red coloured key tumblers & 8 blue coloured keyless tumblers plus 1 clear tumbler ('C' button).
- 4) To change your code, push the 'C' button down and hold it. You can then easily remove one or more of your key & keyless tumblers, using the tweezers supplied.
- 5) Please note you should NEVER remove the 'C' tumbler.
- 6) Please note the different shapes of tumbler, before reinserting them into the lock body. Firstly there is a difference in shape between the key & keyless tumblers, illustrated below, And secondly when refitting the tumblers into the lock body, they must be fitted facing the right way, again see the illustration below.
- 7) After you have refitted the tumblers and made a note of the new code, please replace the metal plate with the 4 screws.
- 8) PLEASE NOTE. With the spare tumblers provided, you can either increase the number of digits in your code to 6 or 7 or reduce to 4.

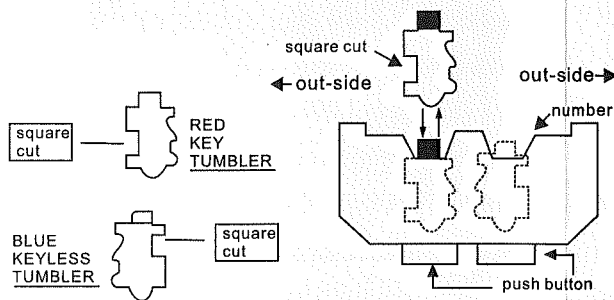

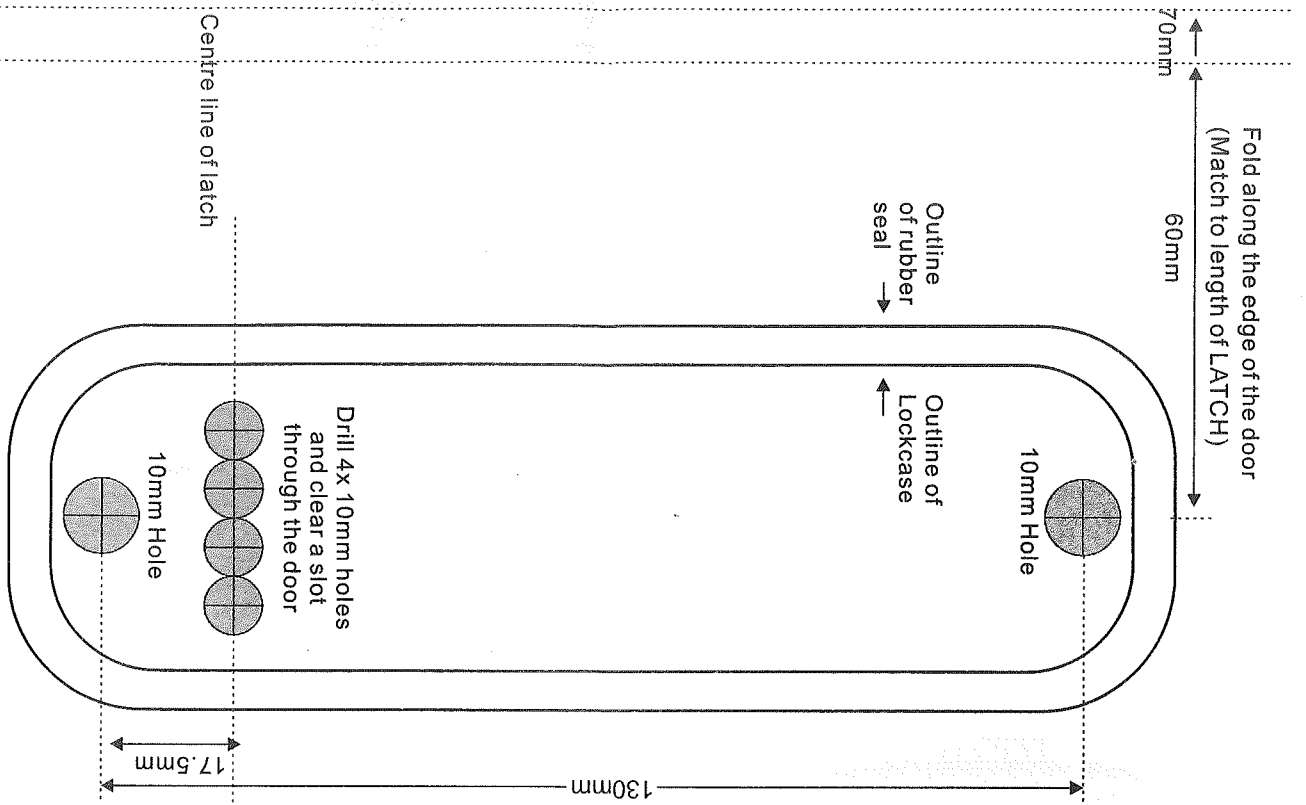

# TEMPLATES

