

1. Mortice lock installation

Note

- Installation for both left handed door and right handed doors are the same
- Before installation, adjust the direction of the latch bolt and strike plate as the per door opening direction

Mortice lock installation

1. Insert mortice body* into mortice pocket and fix in place with screws.
2. Pull out mortice cable to internal side of the door

* Install with latch at the top

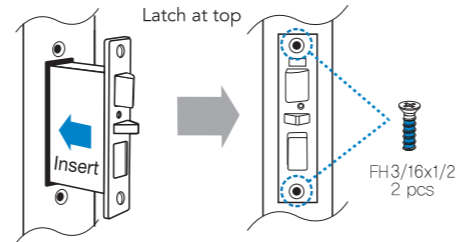

How to change the direction of the latch bolt

1. Insert pin into hole and push until latch bolt protrudes
2. Change the direction of the latch bolt and push the latch bolt, until it locks

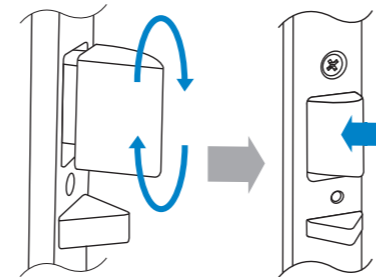
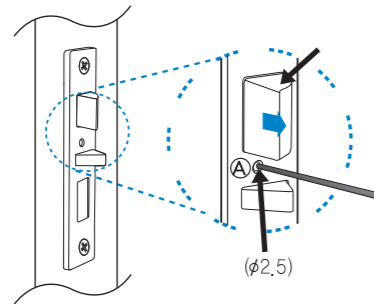

How to install spindle

1. Insert spindle from internal to external
2. Fix stop ring in the hole on outer part of spindle

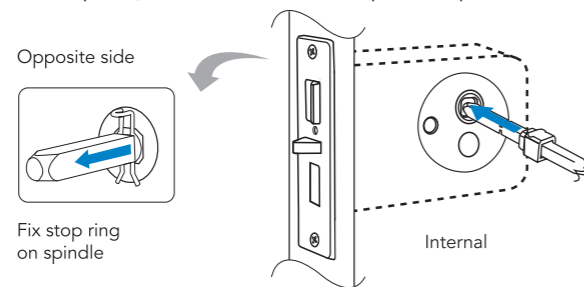

How to install strike

1. Insert strike housing and set the curved part of striker to direction of door opening
2. Fix it with screws

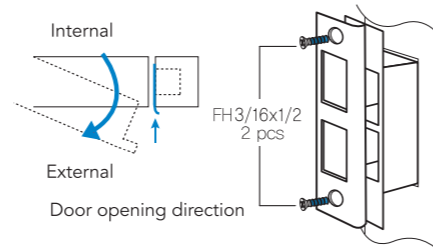

Opening system of mortice lock

- When the door is locked, the external handle is not connected to the deadbolt. Pulling down the handle the deadbolt remains extended.
- If the door is unlocked, the handle is connected to deadbolt and operating the handle will retract deadbolt

Benefits:

- 1) **High security level:** In locked status, outer handle is not connected to the deadbolt (independent movement of latch bolt and deadbolt)
- 2) **Durability:** Ensures long life because deadbolt is not operated by motor system
- 3) **Easy installation:** Direction of latch bolt can be changed after the installation is finished

2. Lock body installation

⚠ Read below before installation

1. Insert spindle to "spindle hole" of installation template and stick the template to inside. Fold the template along the folding line.
2. Fix the exact position of template and mark the drilling position to make the hole. Mark the drilling position on the opposite side in the same way.

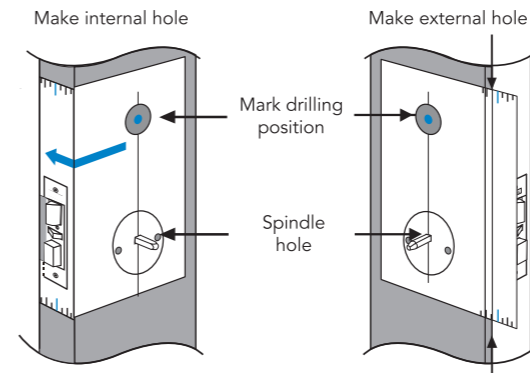

3. Drill hole as per specification (32mm)
4. Set the direction of the handle on external unit. Pull down the handle to horizontal position, until it is fixed with a click sound

- To reset the direction of the handle, push up the 'handle direction changing lever' which is located on the inside of each unit. Handle will return to middle position

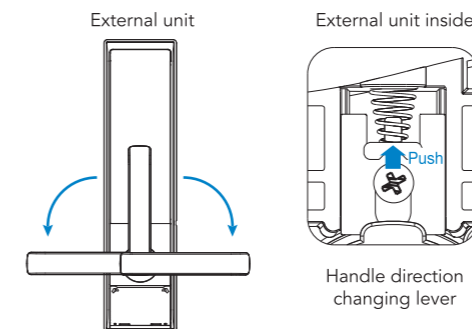

5. Pull the cable from the external unit through the upper hole to the internal side of the door. Pull out the cable from the external unit and mortice lock cable through the hole of the back plate. Fix the back plate to the external unit using screws

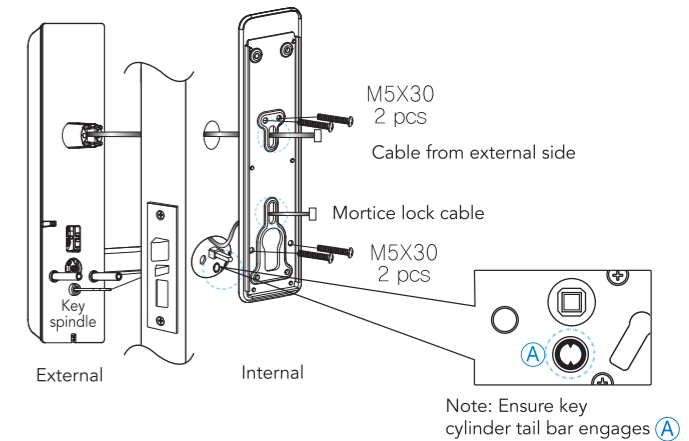

6. Connect two cables to PCB and fix the internal unit with screws.

- Set the direction of handle of internal unit

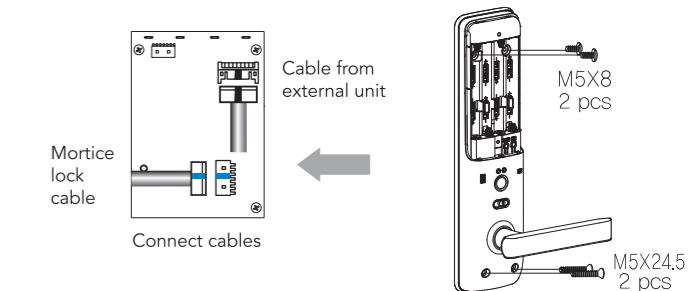

Check operation of product

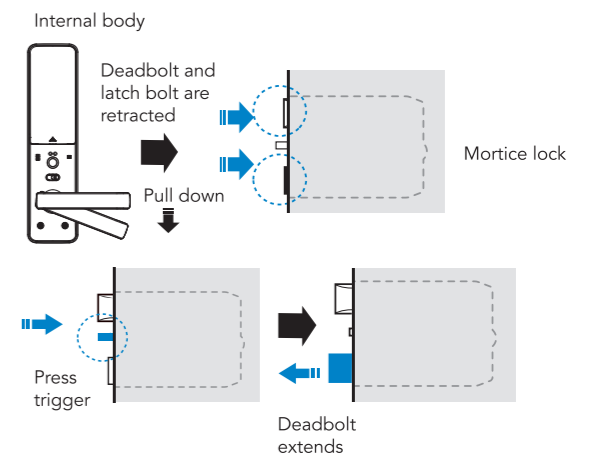

- Pull down the handle of internal unit. Latch bolt and deadbolt is retracted and door is opened

⚠

- Insert batteries correctly and conduct testing from inside
- If you close the door from outside and installation is not perfect you cannot open the door
- Register code as per user manual
- For factory settings refer to the user manual

Installation Template Hafele EL8000



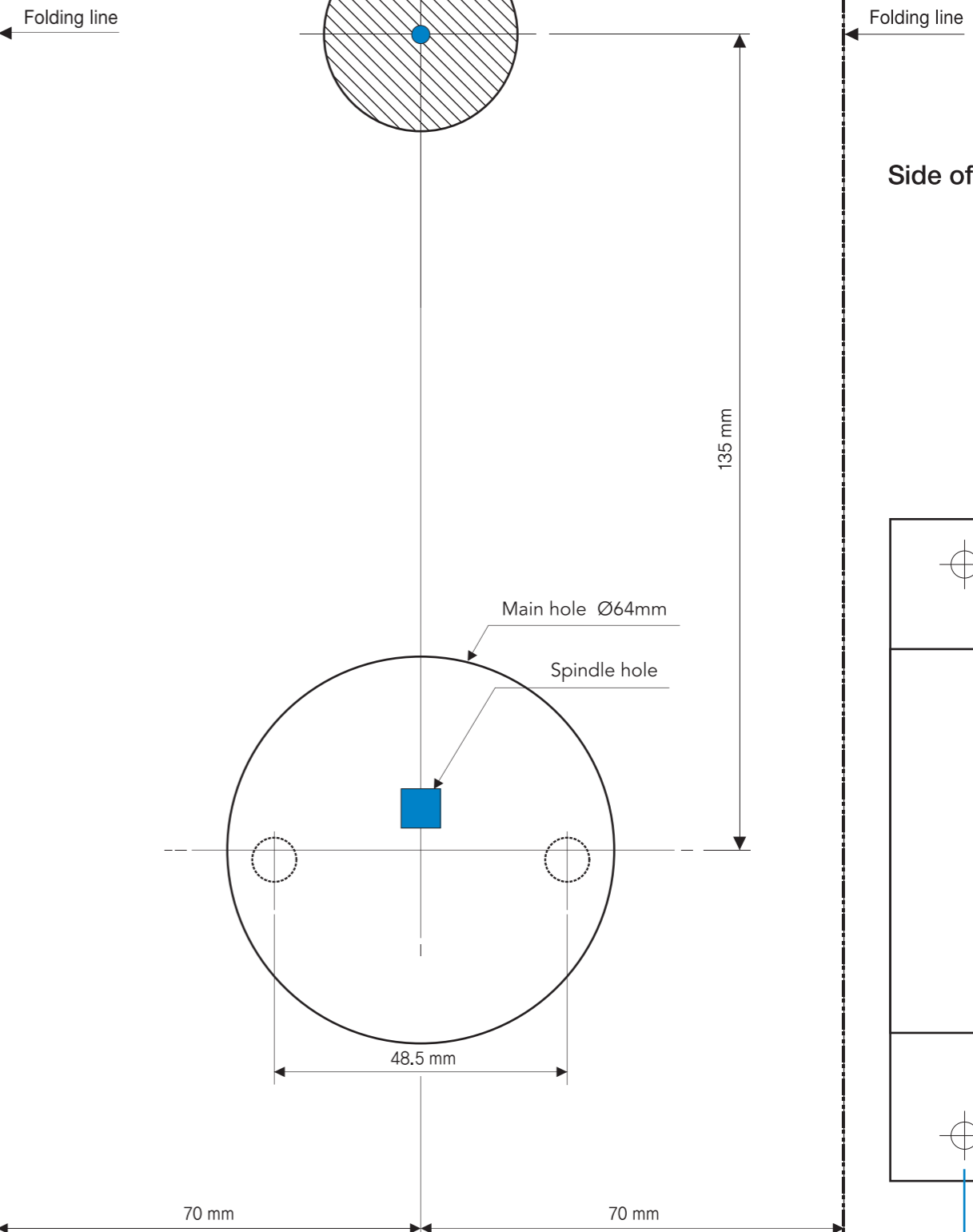

⚠ Please check measurements when printing template



Side of door

Side of door

Screws

-  FH3/16x1/2 4 pcs
-  M5x24.5 2 pcs
-  M5x8 2 pcs
-  M5x30 4 pcs

