

Selector[®] 3700 Series Mortice Locks



We take the worry out of
protecting what's valuable to you.
Lockwood: *no worries*[®]

LOCKWOOD

ASSA ABLOY

25YEAR

**MECHANICAL
WARRANTY**

www.lockweb.com.au

Contents



Selector® 3770 Series

Standard Backset
Mortice Locks

page 5



Selector® 3770

Mortice Nightlatches

page 8



Selector® 3772

Escape Locks

page 11



Selector® 3774

Passage Latch

page 17



Selector® 3774

Combination Locks

page 20



Selector® 3777

Dual Entry Locks

page 25



Selector® Privacy

Privacy Locks

page 28



Selector® 3772 DX Digital

DX Digital Mortice Locks

page 32



Selector® 3772 DX Digital

Key Override DX Digital
Mortice Locks

page 35



Selector® 3770 Series Accessories

Standard Backset Mortice
Lock Accessories

page 38



Selector® 3770 Series Function Guides

Function Chart, Synergy®
Conversion Chart and
Functioning Matrix

page 44



Selector® 3780 Series

Short Backset Mortice Locks

page 48

Contents



Selector® 3782

Short Backset Escape Locks

page 51



Selector® 3784

Short Backset
Combination Locks

page 56



Selector® 3787

Short Backset Dual
Entry Locks

page 61



Selector® 3782 DX Digital

Short Backset DX Digital
Mortice Locks

page 64



Selector® 3782 DX Digital

Short Backset Key Override
DX Digital Series

page 67



Selector® 3780 Series Accessories

Short Backset Mortice Lock
Accessories

page 70



Selector® 3780 Series Function Guides

Function Chart, Synergy
Conversion Chart and
Functioning Matrix

page 77



Selector® 3770 Series Mortice Locks

Selector® 3770 Series Cylinder Mortice Locks

Application

A comprehensive range of cylinder mortice locks suitable for heavy duty use in industrial and commercial buildings, institutions, clubs, schools, hospitals, hotels and similar buildings.

Benefits

- Easy red/green function setting
- All lock settings are made from under the faceplate allowing for simple in-door configuration
- Standard primary locks include anti-lockout and holdback capabilities
- Improved cylinder functions including lock/unlock and retract latch as standard
- Through-fixing of rose furniture turnknobs and escutcheons
- Reduced range of cylinder cams and turn adaptors relative to other commonly available commercial cylinder mortice locks

Features and Specifications

The Australian designed and made Selector® 3770 Series Cylinder Mortice Locks are made from quality materials to meet high durability and strength requirements.

Case and Faceplates

- High purity zinc alloy material cases with stainless steel chassis plates. Stainless steel faceplates provided as standard.
- Brass faceplates available for alternative finishes

Backset

- 60mm standard backset
- Extended backsets 89mm and 127mm are available - Refer to Function Matrix (Page 43)

Latch Bolts

- Latch bolts are made with stainless steel, 15mm in size
- Deadlatching is achieved by an auxiliary stainless steel latch bolt
- Reversible for both left and right hand doors, opening in or opening out whilst lock is in door
- Electric Strike compatibility
- Separate auxiliary bolt moves into lock case simultaneously with latch bolt
- Radius bolt provides greater deadlatch throw and smoother closing action

Cylinder Retaining Pin

Hard-drawn spring steel wire, corrosion protected.

Door Thickness

- 32mm to 50mm

Components to facilitate use on thicker doors are available on application.

Door Clearance

To ensure correct functioning of the deadlatching mechanism and security for all locks, the clearance between the door and the frame should be 3mm. The deadlatching will operate up to 8mm door clearance however, door clearances over 5mm are not recommended.

Aluminium Doors

Specify Selector® 3772-AFKIT for aluminium door fixing kit to convert a timber fix lock to suit aluminium door fixing. The aluminium door fixing kit comes with a 156mm by 25mm radius corner faceplate common to other aluminium door locks.

Security

All Selector® 3770 Series Cylinder Mortice Locks conform with Level S7 (Physical Security) Australian Lock Standard (AS-4145.2-2008). Conforms to Level S8 (Physical Security) when fitted with door furniture and anti-drill cylinder.

Durability

All Selector® 3770 Series Cylinder Mortice Locks conform with Level D8 (Durability) Australian Lock Standard (AS 4145.2-2008).

Fire Rating

All Selector® 3770 Series Mortice Locks have been successfully tested up to 4 hours (depending on type of doorset) on fire door assemblies in accordance with Australian Standard AS 1905.1-2005, Part 1: Fire Resistant Doorsets*.

Anti-Corrosion

All Selector® 3770 Series Cylinder Mortice Locks conform with Level C6 (168 hours) Australian Lock Standard (AS4145.2-2008).

Cylinder

Requires standard Lockwood oval shaped brass cylinders and brass barrels. Lockwood cylinders include bump resistant five pin tumbler mechanism.

Functions require the use of different cams and adaptors.

Keying

Restricted Special Keying

Lockwood locks can be keyed to a number of controlled and/or specially keyed systems. These range from legally protected keys to protect against unauthorised duplication and can also include specially designed keying systems such as master key systems. This allows for different levels of mechanical access control.

Please refer to assaabloy.com.au for keying systems or contact your local sales office or customer service for specific information.

Standard Finishes

Stainless Steel SS

Extended Cylinders

Modular Cylinder Extensions are available for thicker doors.

Rebate

Rebate kits to suit 13mm standard rebate are available.

Electric Strikes

Lockwood offers a wide range of electric strikes which are compatible with the Selector® 3770 Series Mortice Locks. Refer to lockweb.com.au for further details.

S7 HIGH SECURITY

D8 DURABILITY

FIRE RATED

ANTI-CORROSION

Note:

*For questions concerning our fire rated products, their specifications and their utilization please contact ASSA ABLOY or relevant Fire Door Manufacturer.

All dimensions depicted in this brochure are in mm.

Selector® 3770 Series Cylinder Mortice Locks

1. Multi-function Lock

The new Selector® 3770 Series Mortice Lock was designed to incorporate the full range of lock functions into one primary lock. This reduces stock line items. All functions can be configured by adjusting the hub setting selector, lock function selector as well as using cylinder cams and turn adaptors.

2. Hub Setting Selection

Hub setting can be adjusted via the Selector® 3770 Series hub selector located under the faceplate of the mortice lock. The hub setting allows for three functions: Passage, Combination, or Escape function.

This is done by rotating the dial with a 4mm flat blade screwdriver.

RED - Handle is lockable. Only opened by handle when locking bar is unlocked (up).

GREEN - Opened by handle at all times.

3. Lock Function Setting

The new Selector® 3770 Series Mortice Lock was designed to incorporate a greater range of lock functions into one primary lock. In addition to anti-lockout setting, the Selector® 3770 series also includes an industry first selectable holdback feature.

N - Neutral Lock
Factory default
Lock operates as a standard lock

A - Anti-lockout Lock
Closing the door or retracting the latch bolt unlocks the lock, preventing lockout situations.

H - Holdback Lock
Latch bolt can be held within the lock.

Holdback must not be activated on fire doors.

4. Backset

Standard backset - 60mm. Extended backsets 89mm and 127mm are available

5. Case Assembly

Zinc diecast body with stainless steel chassis plates for improved strength.

6. Furniture Through Fix Holes

Through fixed escutcheons and turnknobs can now be used with the lock, allowing for more robust fixing of door furniture.

7. Cylinder/Adaptor Retention

"Slip Pin" Cylinder/Adaptor fixing method, which allows attachment to the case by inserting a non-threaded cylindrical pin through the front of the lock case.

8. Cylinder Assembly

Five pin tumbler mechanism. Standard Lockwood oval shaped, brass cylinders and brass barrels. Only two newly designed cams needed for all lock functions.

X7 Cam - Retracts latch bolt with additional ability of locking the locking bar.

V Cam - Locks and unlocks the locking bar. Also retracts latch bolt after unlocking lock.

9. Synergy Retrofit

The Selector® 3770 Series Mortice Lock is designed to have an equivalent case size as the Synergy Series Mortice Lock to ensure retrofitability.

10. Kits

The Selector® 3770 Series primary lock is designed for timber doors. Various kit conversions are available for aluminium door applications, alternative finishes as well as dual entry and DX digital locksets.

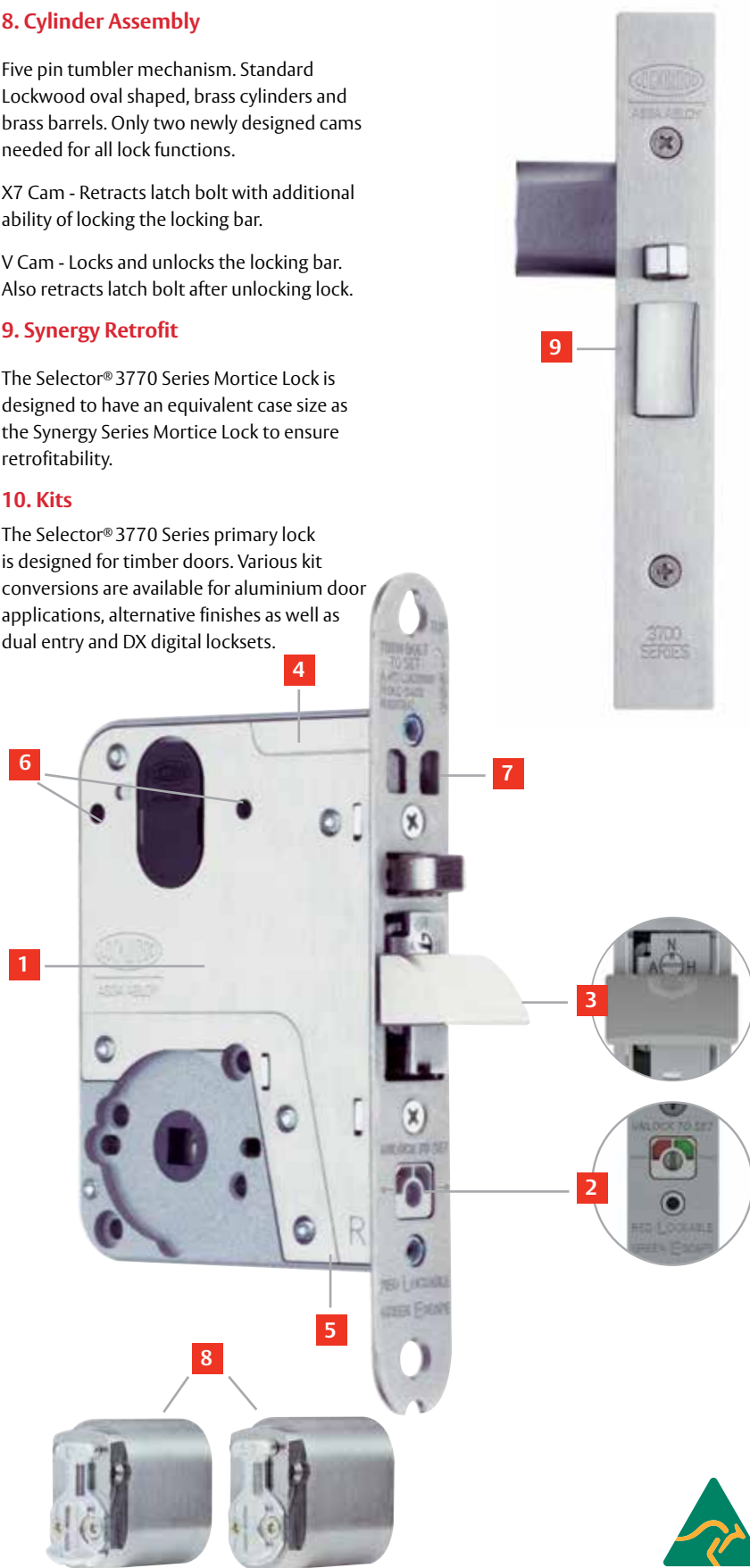

Selector[®] 3770 Mortice Nightlatches



Description

These locks have various latching functions operated by a key outside and by a turnknob or key inside. The mortice nightlatch locks automatically when the door is closed.

Product Details

| | |
|------------------|---|
| Backset | Available in 60, 89 and 127mm backsets. |
| Furniture | Compatible with most Lockwood cylinder escutcheons, turnknobs and plate furniture. Refer to lockweb.com.au for further details. |
| Latch | Deadlatch only. |
| Standard | Stainless Steel (SS) |
| Finishes | Other finishes available via finish kit conversions |

Selector® 3770 Mortice Nightlatches

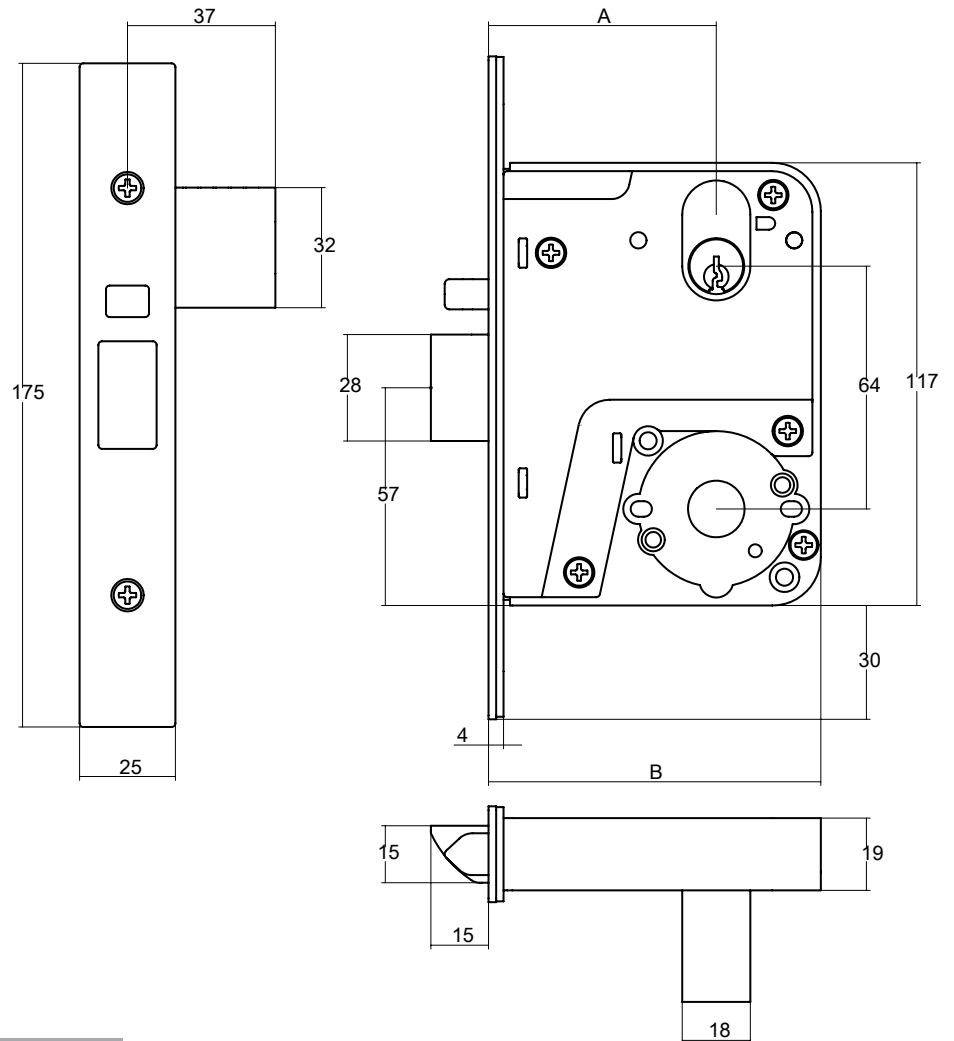

Selector® 3770 Mortice Nightlatches

| Part Number | 3770 | 4770 | 5770 |
|-------------|------|------|------|
| Dimension A | 60 | 89 | 127 |
| Dimension B | 88 | 117 | 155 |

Note: 3772SS Primary Lock can be used to achieve 3770 functions.

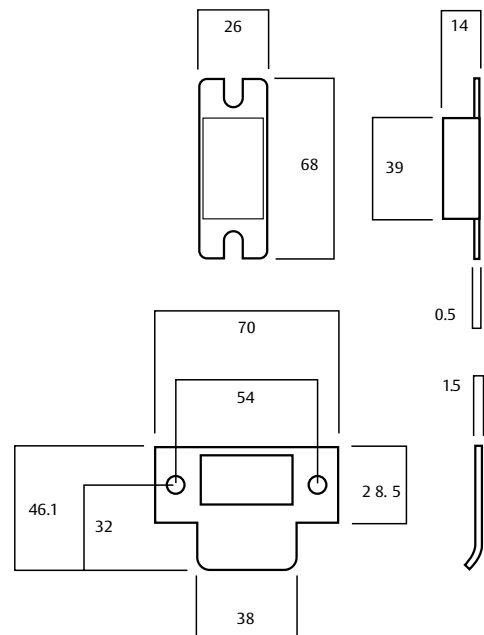

Selector[®] 3770 Mortice Nightlatches

Nightlatch with Turn

Part Number 3770-T

Turnknob inside.

Inside: Opened by turnknob.

This function requires the locking bar to be positioned in the locked position once lock is set.

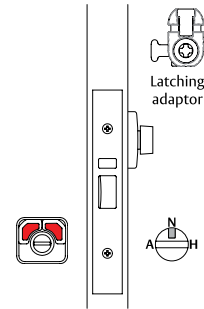

Nightlatch with Cylinder

Part Number 3770X-

Single cylinder.

Outside: Opened by key.

This function requires the locking bar to be positioned in the locked position once lock is set.

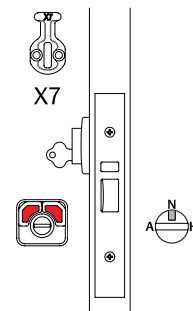

Nightlatch with Cylinder and Turn

Part Number 3770XT

Cylinder and turnknob.

Outside: Opened by key.

Inside: Opened by turnknob.

This function requires the locking bar to be positioned in the locked position once lock is set.

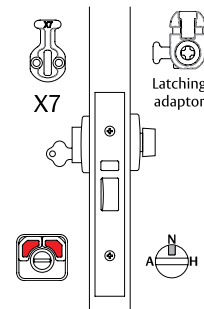

Nightlatch with Double Cylinder

Part Number 3770XX

Double cylinder.

Outside: Opened by key.

Inside: Opened by key.

This function requires the locking bar to be positioned in the locked position once lock is set.

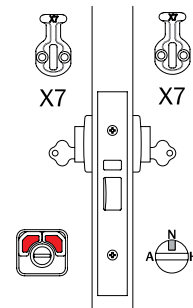

Notes:

All drawings shown are in right hand configuration. Setting instructions only apply if 3772 is used, disregard instructions if using 3770. Part numbers shown above are for 60mm backset lock, if 89mm is required substitute 3 for 4 i.e. 4770, or if 127mm lock is required, substitute 3 for 5 i.e. 5770

Legend

Hub Setting



Lock Function Setting



Cam or Adaptor



Selector® 3772 Escape Locks



Description

These locks have various latching functions which can be operated by key or handle outside and by turnknob, key or handle inside.

Product Details

| | |
|--------------------------|--|
| Backset | Available in 60, 89 and 127mm backsets. |
| Furniture | Compatible with most Lockwood rose and plate furniture including Brass Door Furniture, Robert Watson Series, Artefact Series II, Ovation Series and VSR Series. Refer to lockweb.com.au for further details. |
| Latch | Deadlatch only. |
| Standard Finishes | Stainless Steel (SS) Other finishes available via finish kit conversions |

Selector® 3772 Escape Locks

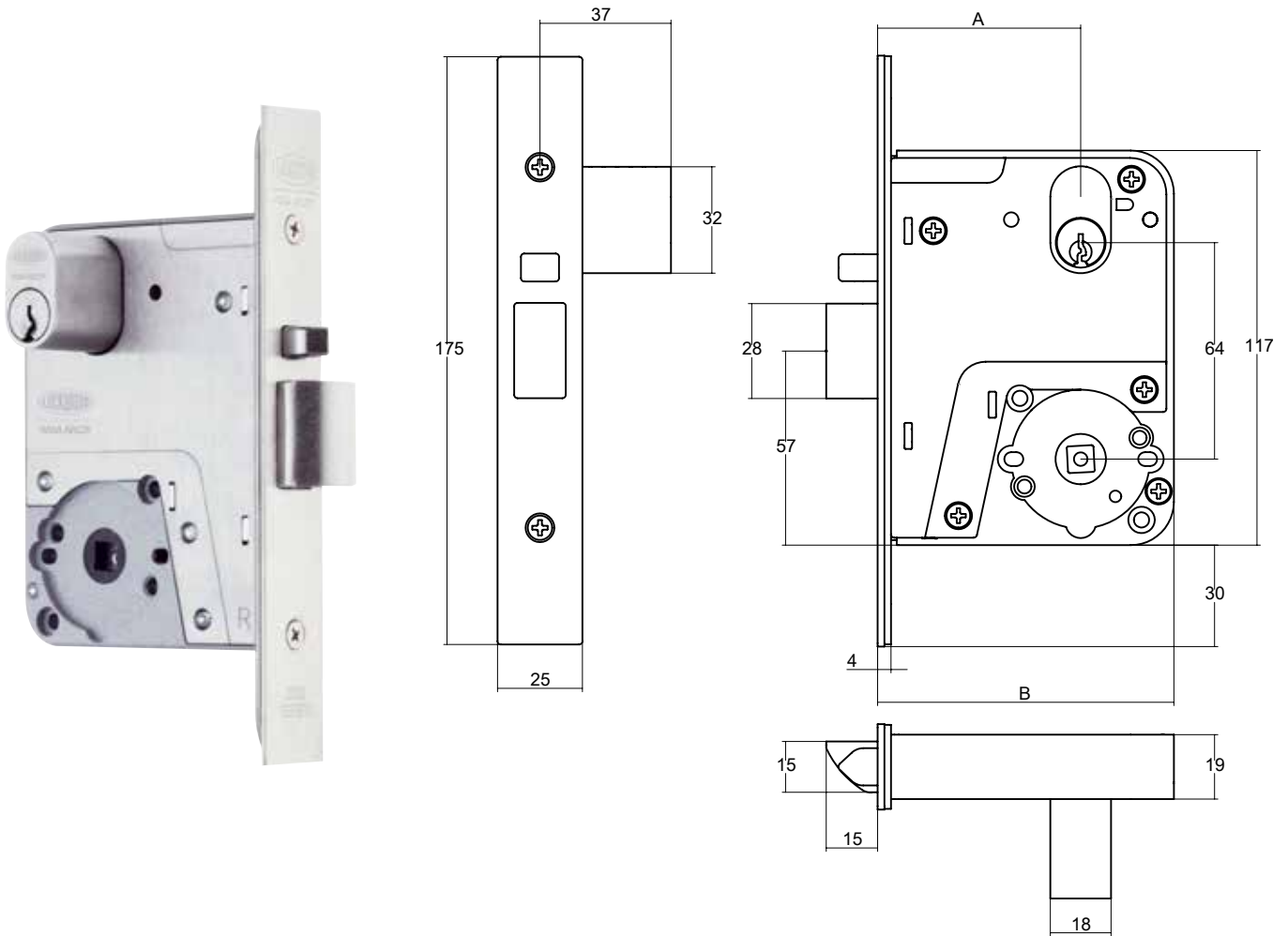

Selector® 3772 Escape Locks

| Part Number | 3772 | 4772 | 5772 |
|-------------|------|------|------|
| Dimension A | 60 | 89 | 127 |
| Dimension B | 88 | 117 | 155 |

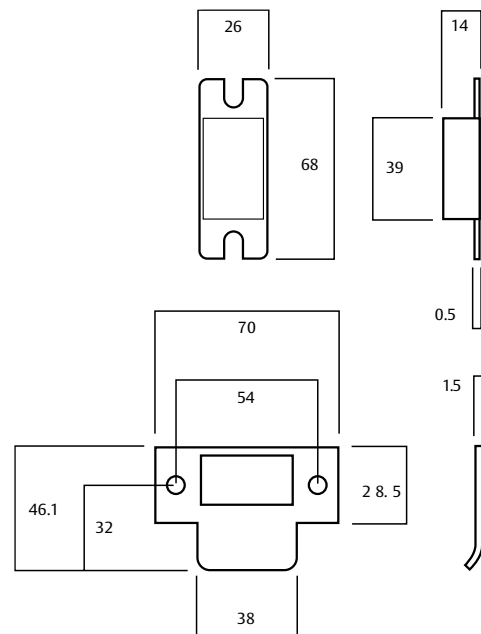

Selector[®] 3772 Escape Locks

Escape Lock

Part Number 3772--

Outside: Handle always rigid.

Inside: Opened by handle at all times.

This function requires the locking bar to be positioned in the locked position once lock is set.

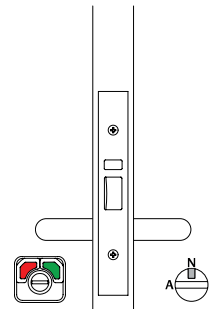

Anti-vandal Escape Lock

Part Number 3772V-

Single cylinder.

Outside: Opened by handle when unlocked. Key locks and unlocks outside handle and retracts bolt after unlocking lock.

Inside: Opened by handles at all times.

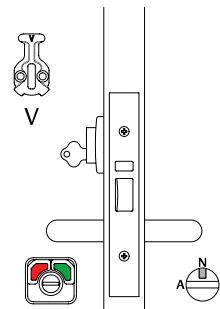

Anti-vandal Escape Lock with Turn

Part Number 3772VT

Cylinder and turnknob.

Outside: Opened by handle when unlocked. Key locks and unlocks outside handle and retracts bolt after unlocking lock.

Inside: Opened by handle at all times. Turnknob locks or unlocks outside handle.

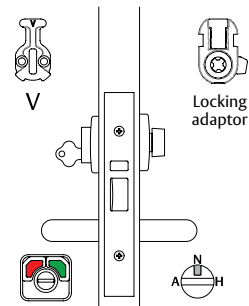

Key Entry Escape Lock

Part Number 3772X-

Single cylinder.

Outside: Opened by key at all times. Handle always rigid.

Inside: Opened by handle at all times.

This function requires the locking bar to be positioned in the locked position once lock is set.

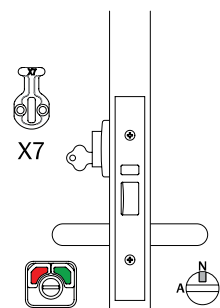

Notes:

All drawings shown are in right hand configuration. Part numbers shown above are for 60mm backset lock, if 89mm is required substitute 3 for 4 i.e. 4772, or if 127mm lock is required, substitute 3 for 5 i.e. 5772

Legend

Hub Setting



Lock Function Setting



Cam or Adaptor



Selector[®] 3772 Escape Locks

Key Entry Escape Lock with Turn

Part Number 3772XT

Cylinder and turnknob.

Outside: Opened by key at all times. Opened by handle when unlocked. Key locks outside handle.

Inside: Opened by handle at all times. Turnknob locks or unlocks outside handle.

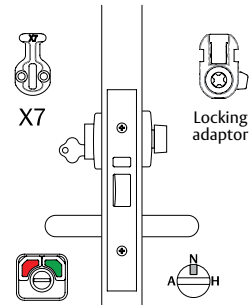

Escape Lock with Internal Cylinder

Part Number 3772-V

Single cylinder.

Outside: Opened by handle when unlocked.

Inside: Opened by handle at all times. Key locks or unlocks outside handle and retracts bolt after unlocking lock.

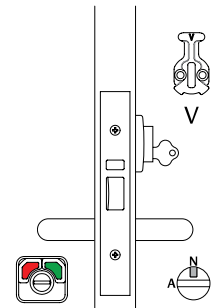

Escape Lock with Turn

Part Number 3772-T

Turnknob inside.

Outside: Opened by handle when unlocked.

Inside: Opened by handle at all times. Turnknob locks or unlocks outside handle.

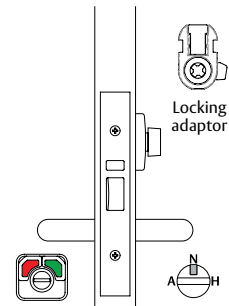

Anti-vandal Escape Lock with Internal Cylinder

Part Number 3772VV

Double Cylinder.

Outside: Opened by handle when unlocked. Key locks or unlocks outside handle and retracts bolt after unlocking lock.

Inside: Opened by handle at all times. Key locks or unlocks outside handle and retracts bolt after unlocking lock.

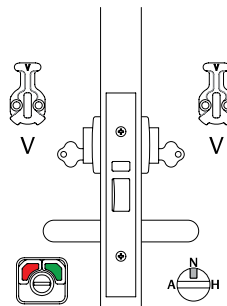

Notes:

All drawings shown are in right hand configuration. Part numbers shown above are for 60mm backset lock, if 89mm is required substitute 3 for 4 i.e. 4772, or if 127mm lock is required, substitute 3 for 5 i.e. 5772

Legend

Hub Setting



Lock Function Setting



Cam or Adaptor



Selector® 3772 Escape Locks

Key Entry Escape Lock with Internal Cylinder

Part Number 3772XV

Double cylinder.

Outside: Opened by key at all times. Opened by handle when unlocked. Key locks outside handle.

Inside: Opened by handle at all times. Key locks or unlocks outside handle and retracts bolt after unlocking lock.

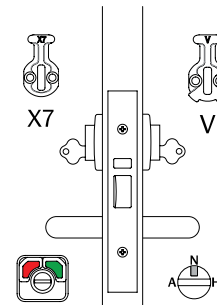

Anti-lockout Escape Lock with Turn*

Part Number 3772-TA

Turnknob inside.

Outside: Opened by handle when unlocked.

Inside: Opened by handle at all times. Turnknob locks or unlocks outside handle.

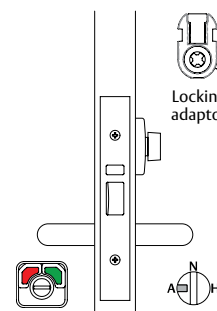

Anti-lockout Anti-vandal Escape Lock with Turn*

Part Number 3772VTA

Cylinder and turnknob.

Outside: Opened by handle when unlocked. Key locks or unlocks outside handle and retracts bolt after unlocking lock.

Inside: Opened by handle at all times. Turnknob locks or unlocks outside handle.

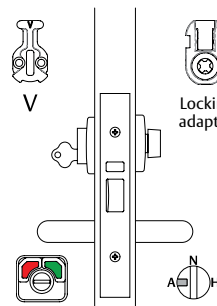

Holdback Anti-vandal Escape Lock#

Part Number 3772V-H

Single cylinder.

Outside: Opened by handle when unlocked. Key locks or unlocks outside handle and retracts bolt after unlocking lock.

Inside: Opened by handle at all times.

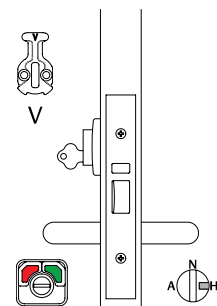

Notes:

All drawings shown are in right hand configuration. Part numbers shown above are for 60mm backset lock, if 89mm is required substitute 3 for 4 i.e. 4772, or if 127mm lock is required, substitute 3 for 5 i.e. 5772

*Anti-lockout - Closing the door or retracting latch bolt unlocks the lock, preventing lockout situations.

Holdback - Latch bolt can be held within the lock. **Holdback must not be activated on fire doors.**

For questions concerning our fire rated products, their specifications and their utilization please contact ASSA ABLOY or relevant Fire Door manufacturer.

Legend

Hub Setting



Lock Function Setting



Cam or Adaptor



Selector® 3772 Escape Locks

Holdback Anti-vandal Escape Lock with Turn#

Part Number 3772VTH

Cylinder and turnknob.

Outside: Opened by handle when unlocked. Key locks or unlocks outside handle and retracts bolt after unlocking lock.

Inside: Opened by handle at all times. Turnknob locks or unlocks outside handle.

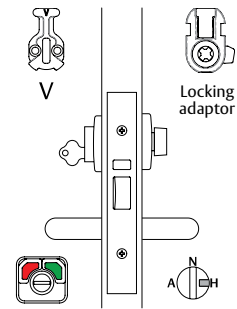

Holdback Key Entry Escape Lock with Internal Cylinder#

Part Number 3772XVH

Double cylinder.

Outside: Opened by key at all times. Opened by handle when unlocked. Key locks outside handle.

Inside: Opened by handle at all times. Key locks or unlocks outside handle and retracts bolt after unlocking lock.

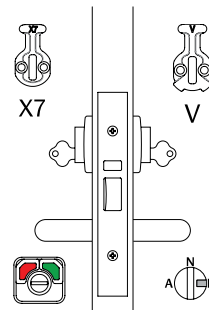

Notes:

All drawings shown are in right hand configuration.

Part numbers shown above are for 60mm backset lock, if 89mm is required substitute 3 for 4 i.e. 4772, or if 127mm lock is required, substitute 3 for 5 i.e. 5772

*Anti-lockout - Closing the door or retracting latch bolt unlocks the lock, preventing lockout situations.

#Holdback - Latch bolt can be held within the lock. **Holdback must not be activated on fire doors.**

For questions concerning our fire rated products, their specifications and their utilization please contact ASSA ABLOY or relevant Fire Door manufacturer.

Legend

Hub Setting



Lock Function Setting



Cam or Adaptor



Selector® 3774 Passage Latch



Description

The Passage latch only has a plainlatch. It allows operation of outside and inside handles at all times with no locking functions. Ideal for interconnecting doors.

Product Details

| | |
|--------------------------|--|
| Backset | Available in 60, 89 and 127mm backsets. |
| Furniture | Compatible with most Lockwood rose and plate furniture including Brass Door Furniture, Robert Watson Series, Artefact Series II, Ovation Series and VSR Series. Refer to lockweb.com.au for further details. |
| Latch | Plainlatch only |
| Standard Finishes | Stainless Steel (SS) Other finishes available via finish kit conversions. |

Selector® 3774 Passage Latch

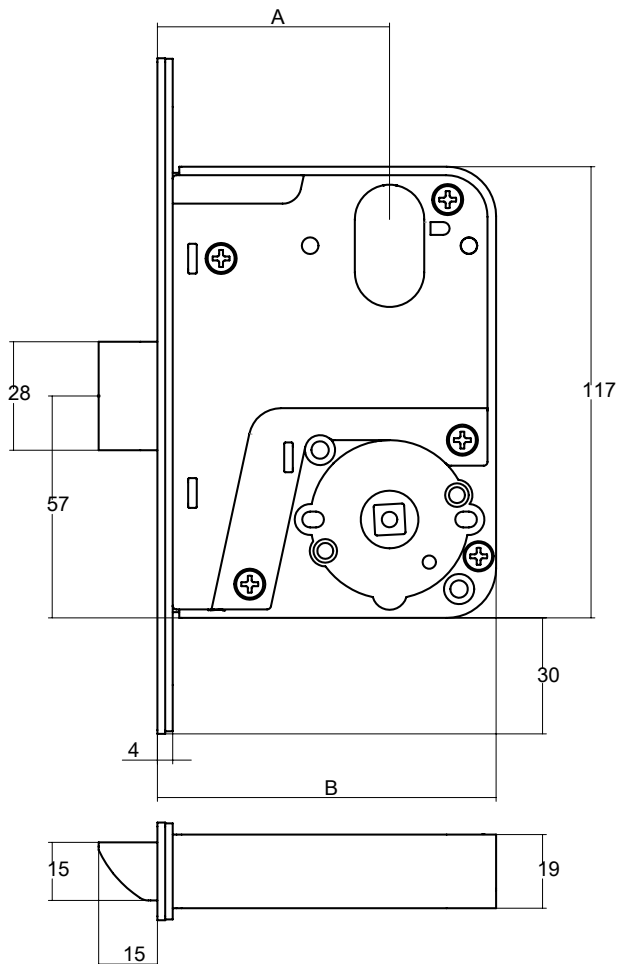
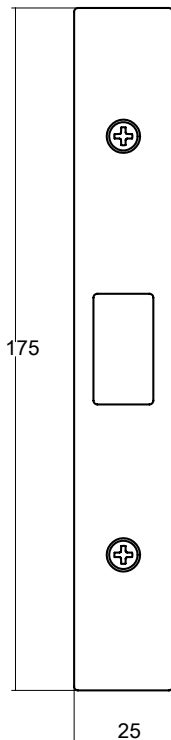

Selector® 3774 Passage Latch

| Part Number | 3774 | 4774 | 5774 |
|-------------|------|------|------|
| Dimension A | 60 | 89 | 127 |
| Dimension B | 88 | 117 | 155 |

Note: Passage Latch primary lock only available in 60mm backset (3774).
For extended backset options, please order 4772/5772 primary lock and configure accordingly.

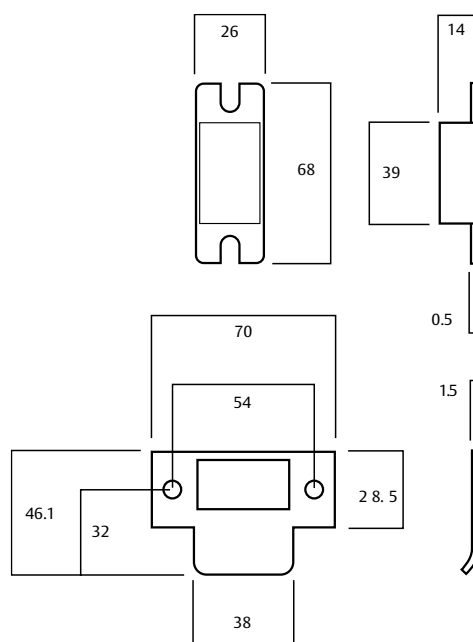

Selector® 3774 Passage Latch

Passage Latch

Part Number 3774

No locking function. Plainlatch only.

Outside: Opened by handle at all times.

Inside: Opened by handle at all times.

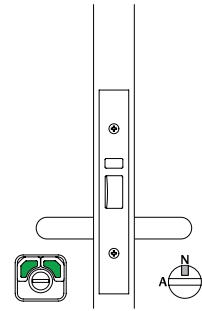

Notes:

Setting instructions only apply if 3772 is used, disregard instructions if using 3774.

All drawings shown are in right hand configuration.

Part numbers shown above are for 60mm backset lock, if 89mm is required substitute 3 for 4 i.e. 4772, or if 127mm lock is required, substitute 3 for 5 i.e. 5772

Legend

Hub Setting



Lock Function Setting



Cam or Adaptor



Selector® 3774 Combination Locks



Description

These locks have various latching functions operated generally by outside or inside handles, except when locked by key outside or by key or turnknob inside.

Product Details

| | |
|--------------------------|--|
| Backset | Available in 60, 89 and 127mm backsets. |
| Furniture | Compatible with most Lockwood rose and plate furniture including Brass Door Furniture, Robert Watson Series, Artefact Series II, Ovation Series and VSR Series. Refer to lockweb.com.au for further details. |
| Latch | Deadlatch only. |
| Standard Finishes | Stainless Steel (SS) Other finishes available via finish kit conversions. |

Selector® 3774 Combination Locks

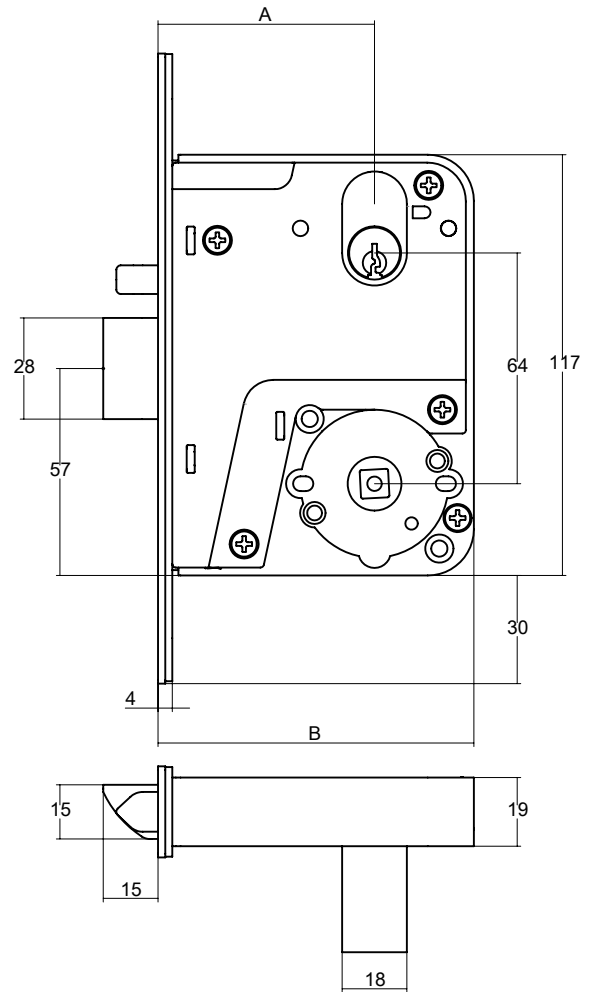
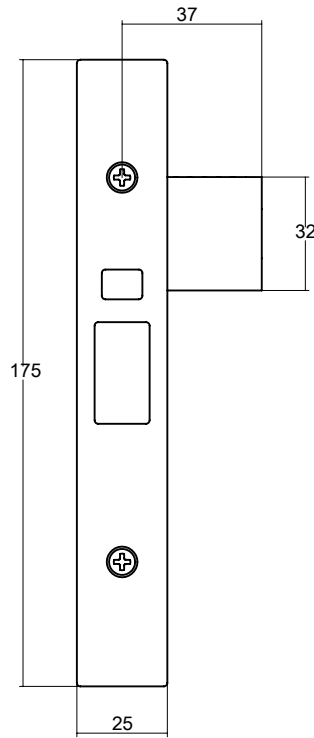

Selector® 3774 Combination Locks

| Part Number | 3774 | 4774 | 5774 |
|-------------|------|------|------|
| Dimension A | 60 | 89 | 127 |
| Dimension B | 88 | 117 | 155 |

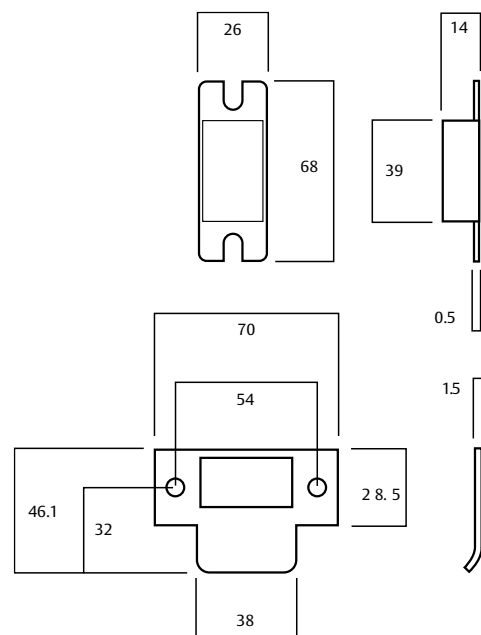

Selector® 3774 Combination Locks

Anti-vandal Lock with Turn

Part Number 3774VT

Cylinder and turnknob.

Outside: Opened by handle when unlocked. Key locks or unlocks both handles and retracts bolt after unlocking lock.

Inside: Opened by handle when unlocked. Turnknob locks or unlocks both handles.

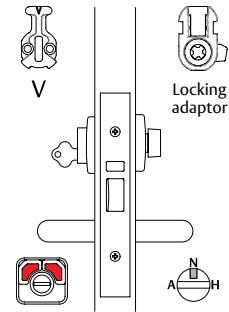

Anti-vandal Lock with Internal Cylinder

Part Number 3774W

Double cylinder.

Outside: Opened by handle when unlocked. Key locks or unlocks both handles and retracts bolt after unlocking lock.

Inside: Opened by handle when unlocked. Key locks or unlocks both handles and retracts bolt after unlocking lock.

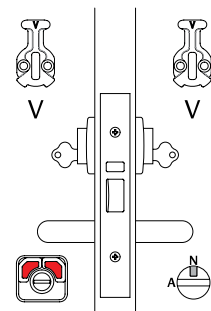

Key Entry Lock with Internal Cylinder

Part Number 3774XV

Double Cylinder.

Outside: Opened by key at all times. Opened by handle when unlocked. Key locks both handles.

Inside: Opened by handle when unlocked. Key locks or unlocks both handles and retracts bolt after unlocking lock.

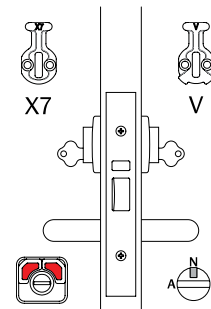

Notes:

All drawings shown are in right hand configuration. Part numbers shown above are for 60mm backset lock, if 89mm is required substitute 3 for 4 i.e. 4774, or if 127mm lock is required, substitute 3 for 5 i.e. 5774

| Legend | |
|-----------------------|--|
| Hub Setting | |
| Lock Function Setting | |
| Cam or Adaptor | |

Selector[®] 3774 Combination Locks

Key Entry Double Cylinder Lock

Part Number 3774XX

Double cylinder.

Outside: Opened by key at all times. Handle always rigid.

Inside: Opened by key at all times. Handle always rigid.

This function requires the locking bar to be positioned in the locked position once lock is set.

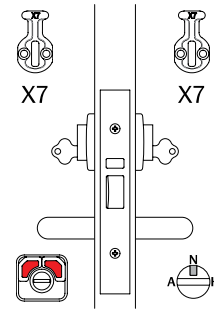

Combination Lock with Turn

Part Number 3774-T

Turnknob inside.

Outside: Opened by handle when unlocked.

Inside: Opened by handle when unlocked. Turnknob locks or unlocks both handles.

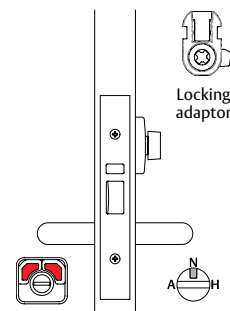

Anti-lockout Combination Lock with Turn*

Part Number 3774-TA

Turnknob inside.

Outside: Opened by handle when unlocked.

Inside: Opened by handle when unlocked. Turnknob locks or unlocks both handles.

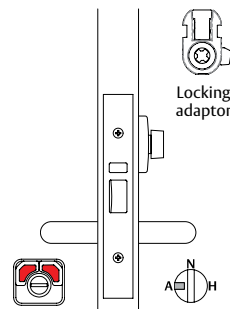

Anti-lockout Anti-vandal Lock with Turn*

Part Number 3774VTA

Cylinder and turnknob.

Outside: Opened by handle when unlocked. Key locks or unlocks both handles and retracts bolt after unlocking lock.

Inside: Opened by handle when unlocked. Turnknob locks or unlocks both handles.

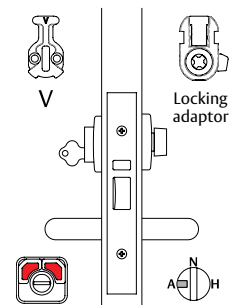

Notes:

All drawings shown are in right hand configuration. Part numbers shown above are for 60mm backset lock, if 89mm is required substitute 3 for 4 i.e. 4774, or if 127mm lock is required, substitute 3 for 5 i.e. 5774

*Anti-lockout - Closing the door or retracting latch bolt unlocks the lock, preventing lockout situations.

| Legend | |
|-----------------------|--|
| Hub Setting | |
| Lock Function Setting | |
| Cam or Adaptor | |

Selector® 3774 Combination Locks

Anti-lockout Anti-vandal Lock with Internal Cylinder*

Part Number 3774VVA

Double cylinder.

Outside: Opened by handle when unlocked. Key locks or unlocks both handles and retracts bolt after unlocking lock.

Inside: Opened by handle when unlocked. Key locks or unlocks both handles and retracts bolt after unlocking lock.

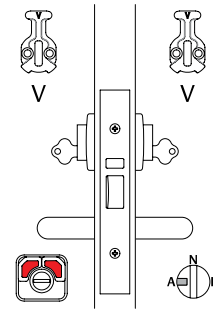

Holdback Anti-vandal Lock with Turn#

Part Number 3774VTH

Cylinder and turnknob.

Outside: Opened by handle when unlocked. Key locks or unlocks both handles and retracts bolt after unlocking lock.

Inside: Opened by handle when unlocked. Turnknob locks or unlocks both handles.

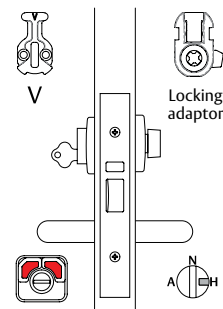

Holdback Anti-vandal Lock with Internal Cylinder#

Part Number 3774VVH

Double cylinder.

Outside: Opened by handle when unlocked. Key locks or unlocks both handles and retracts bolt after unlocking lock.

Inside: Opened by handle when unlocked. Key locks or unlocks both handles and retracts bolt after unlocking lock.

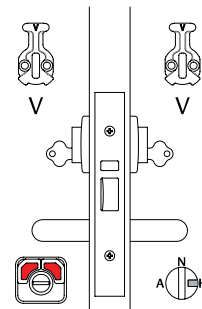

Holdback Key Entry Lock with Internal Cylinder#

Part Number 3774XVH

Double cylinder.

Outside: Opened by key at all times. Opened by handle when unlocked. Key locks both handles.

Inside: Opened by handle when unlocked. Key locks or unlocks both handles and retracts bolt after unlocking lock.

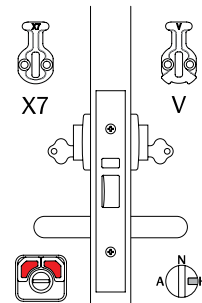

Notes:

All drawings shown are in right hand configuration. Part numbers shown above are for 60mm backset lock, if 89mm is required substitute 3 for 4 i.e. 4774, or if 127mm lock is required, substitute 3 for 5 i.e. 5774

*Anti-lockout - Closing the door or retracting latch bolt unlocks the lock, preventing lockout situations.

#Holdback - Latch bolt can be held within the lock. **Holdback must not be activated on fire doors.**

For questions concerning our fire rated products, their specifications and their utilization please contact ASSA ABLOY or relevant Fire Door manufacturer.

Legend

Hub Setting



Lock Function Setting



Cam or Adaptor



Selector® 3777 Dual Entry Locks



Description

Designed to enable third parties such as emergency services to enter specific areas by second cylinder; without giving access to all locksets in the building and the ability to lockout keys with restricted access at certain times.

Product Details

Furniture

Select from Lockwood 1800, 2800 or Artefact Series II ranges. Refer to lockweb.com.au for further details.

Standard Finishes

Stainless Steel (SS)
Other finishes available via finish kit conversions

Selector® 3777 Dual Entry Locks

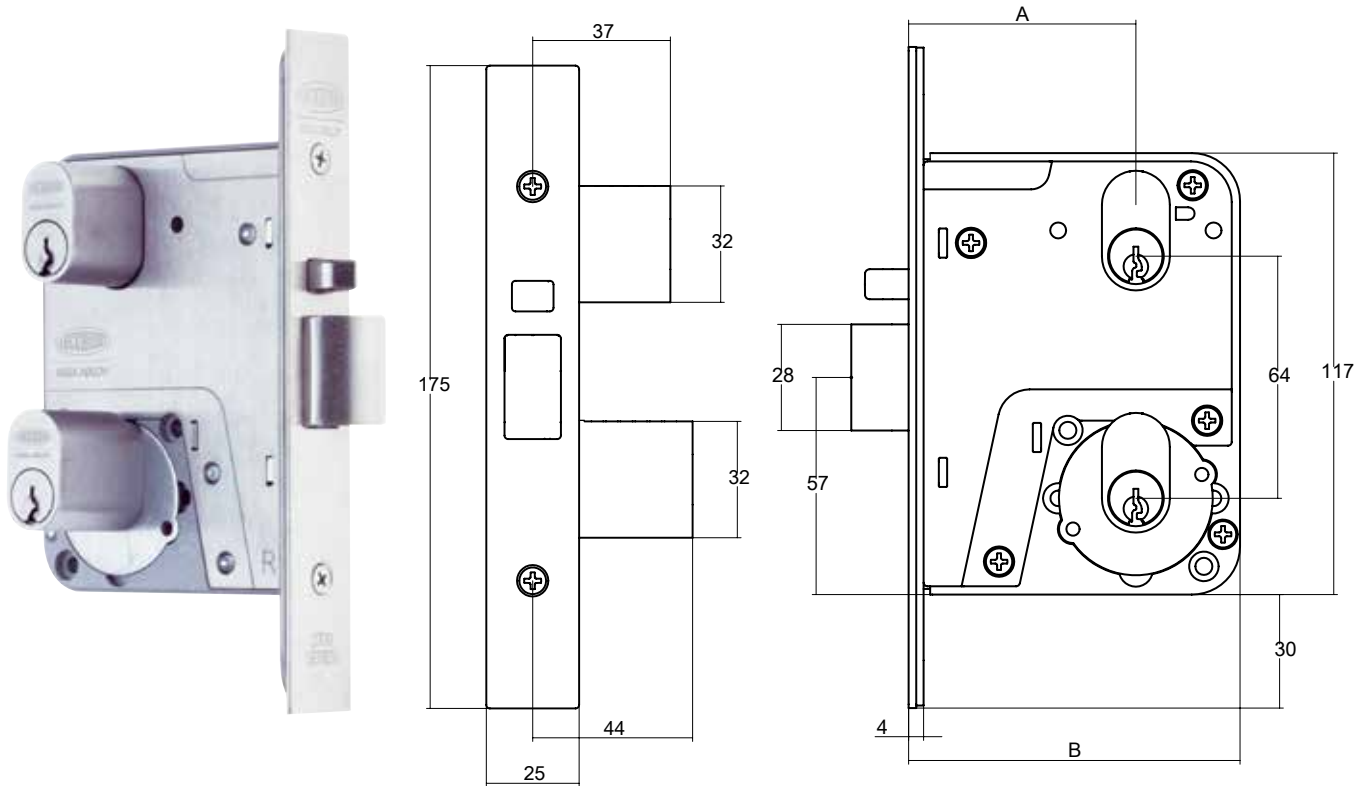

Selector® 3777 Dual Entry Locks

| Part Number | 3777 | 4777 | 5777 |
|-------------|------|------|------|
| Dimension A | 60 | 89 | 127 |
| Dimension B | 88 | 117 | 155 |

Note: Order by specifying 3772SS primary lock and 3777-KIT570E Dual Entry Kit. Cylinders must be ordered separately. 3777-KIT577 Dual Entry Kit may also be used to achieve this function in retrofit applications if existing 577 cylinders are present.

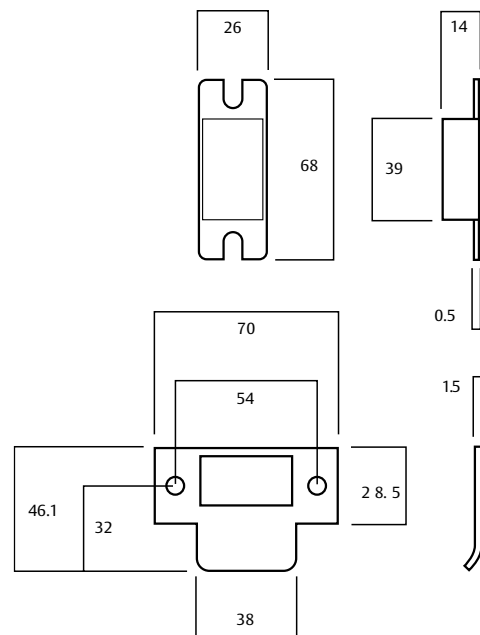

Selector® 3777 Dual Entry Locks

Dual Entry Lock

Part Number 3777X-

Two cylinders outside.

Outside: Opened by key. Cylinders are keyed to differ.

Inside: Opened by handle at all times.

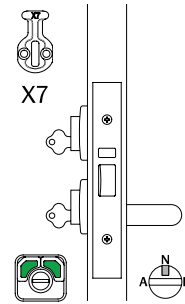

Dual Entry Lock with Lower Cylinder Lockout

Part Number 3777V-

Two cylinders outside.

Outside: Opened by key when unlocked. Upper cylinder key locks or unlocks lower cylinder and retracts bolt after unlocking lock. Cylinders are keyed to differ.

Inside: Opened by handle at all times.

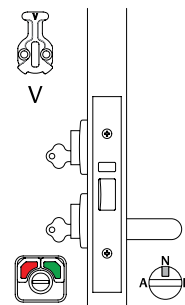

Notes:

All drawings shown are in right hand configuration. Part numbers shown above are for 60mm backset lock, if 89mm is required substitute 3 for 4 i.e. 4777, or if 127mm lock is required, substitute 3 for 5 i.e. 5777

*Anti-lockout - Closing the door or retracting latch bolt unlocks the lock, preventing lockout situations.

| Legend | |
|------------------------------|--|
| Hub Setting | |
| Lock Function Setting | |
| Cam or Adaptor | |

Selector® Privacy Locks



Description

Privacy locks allow doors to be unlocked from the outside via an emergency button. These locks have various latching functions which can be operated by key or handle outside and by handle inside.

Product Details

| | |
|--------------------------|--|
| Backset | Available in 60, 89 and 127mm backsets. |
| Furniture | Compatible with most Lockwood rose and plate furniture including Brass Door Furniture, Robert Watson Series, Artefact Series II, Ovation Series and VSR Series. Refer to lockweb.com.au for further details. |
| Latch | Deadlatch only. |
| Standard Finishes | Stainless Steel (SS) Other finishes available via finish kit conversions |

Selector® Privacy Locks

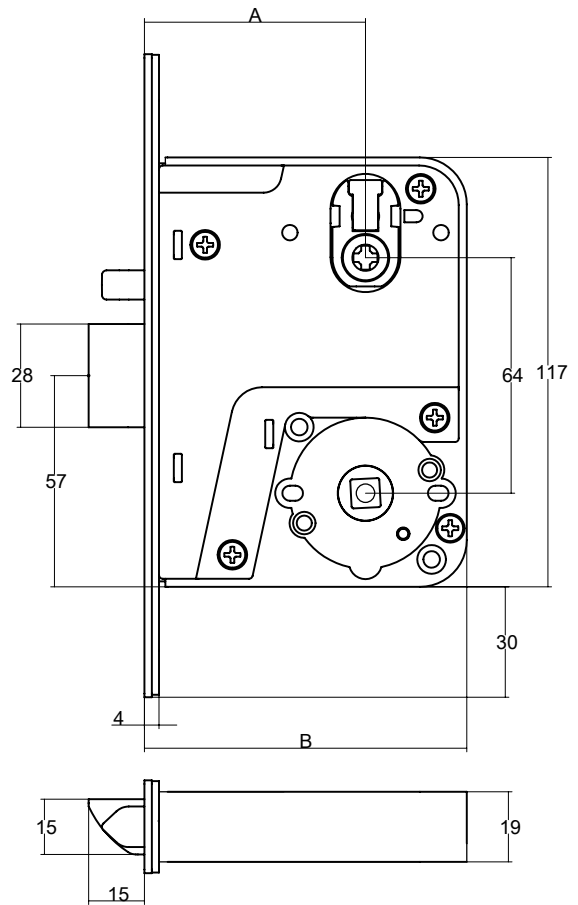
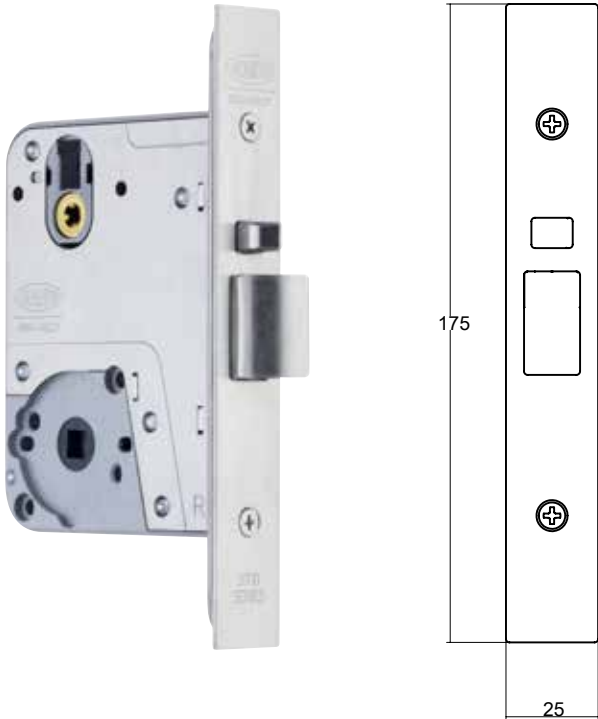

Selector® Privacy Locks

| Part Number | 3772 | 4772 | 5772 |
|-------------|------|------|------|
| Dimension A | 60 | 89 | 127 |
| Dimension B | 88 | 117 | 155 |

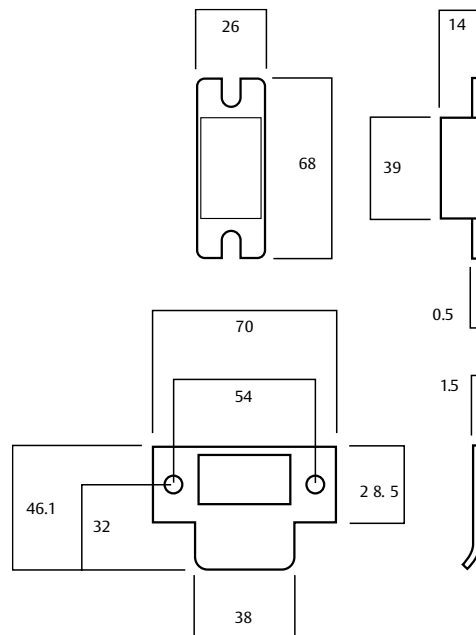

Selector® Privacy Locks

Escape Privacy Lock

Part Number 3772-T

Emergency button and turnknob.

Outside: Opened by handle when unlocked. Emergency button locks or unlocks outside handle - operated by screwdriver or coin.

Inside: Opened by handle at all times. Turnknob locks or unlocks outside handle.

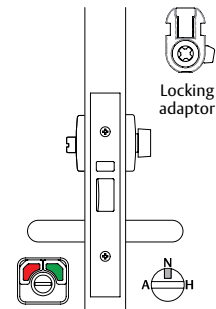

Anti-lockout Escape Privacy Lock*

Part Number 3772-TA

Emergency button and turnknob.

Outside: Opened by handle when unlocked. Emergency button locks or unlocks outside handle - operated by screwdriver or coin.

Inside: Opened by handle at all times. Turnknob locks or unlocks outside handle.

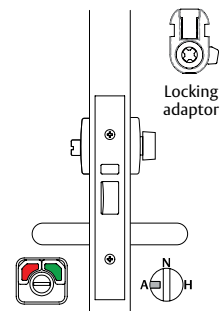

Privacy Lock

Part Number 3774-T

Emergency button and turnknob.

Outside: Opened by handle when unlocked. Emergency button locks or unlocks both handles - operated by screwdriver or coin.

Inside: Opened by handle when unlocked. Turnknob locks or unlocks both handles.

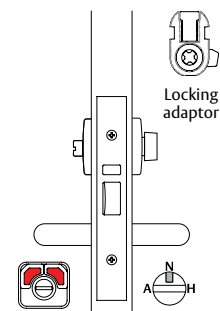

Anti-lockout Privacy Lock*

Part Number 3774-TA

Emergency button and turnknob.

Outside: Opened by handle when unlocked. Emergency button locks or unlocks both handles - operated by screwdriver or coin.

Inside: Opened by handle when unlocked. Turnknob locks or unlocks both handles.

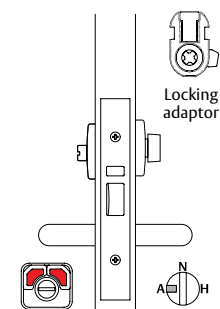

Notes:

All drawings shown are in right hand configuration. Part numbers shown above are for 60mm backset lock, if 89mm is required substitute 3 for 4 i.e. 4772, or if 127mm lock is required, substitute 3 for 5 i.e. 5772

*Anti-lockout - Closing the door or retracting latch bolt unlocks the lock, preventing lockout situations.

Legend

Hub Setting



Lock Function Setting



Cam or Adaptor



Selector® Privacy Locks

Key Entry Privacy Lock

Part Number 3777-T

Lower cylinder outside, emergency button and turnknob.

Outside: Opened by key when unlocked. Emergency button locks or unlocks outside key and inside handle - operated by screwdriver or coin.

Inside: Opened by handle when unlocked. Turnknob locks or unlocks outside key and inside handle.

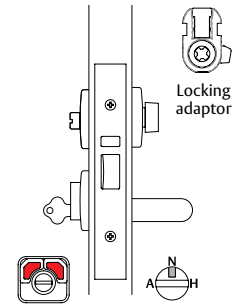

Key Entry Anti-lockout Privacy Lock*

Part Number 3777-TA

Lower cylinder outside, emergency button and turnknob.

Outside: Opened by key when unlocked. Emergency button locks or unlocks outside key and inside handle - operated by screwdriver or coin.

Inside: Opened by handle when unlocked. Turnknob locks or unlocks outside key and inside handle.

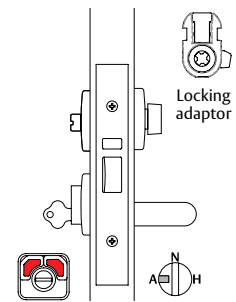

Notes:

All drawings shown are in right hand configuration. Part numbers shown above are for 60mm backset lock, if 89mm is required substitute 3 for 4 i.e. 4772, or if 127mm lock is required, substitute 3 for 5 i.e. 5772

*Anti-lockout - Closing the door or retracting latch bolt unlocks the lock, preventing lockout situations.

Legend

| | |
|------------------------------|--|
| Hub Setting | |
| Lock Function Setting | |
| Cam or Adaptor | |

Selector[®] 3772 DX Digital Mortice Locks



Description

Lockwood DX Digital Locksets provide a mechanical method of keyless entry and are designed to control access into commercial areas.

For extra security when under forced attack, the inbuilt clutching mechanism allows the outside turnknob to rotate without operating or damaging the lock.

The factory set 4 digit code is easily changed to any 4, 5 or 6 digit code using the code changing kit provided with each lock.

As the digital lockset utilizes mechanical operation, electrical wiring is not required.

Outside Function

Press the C button, enter the correct code, then turn the turnknob to unlock the door. Upon releasing the turnknob the code is automatically cancelled.

Product Details

Backset Available in 60, 89 and 127mm backsets.

Door Thickness 32mm to 50mm

Finish Codepad: Satin Chrome Brushed (SC)
Mortice Lock: Stainless Steel (SS)

Codepad Assembly High purity zinc alloy, 45mm wide, 164mm high, 52mm projection

Latch Stainless steel with 15mm projection

Door Furniture (Lockwood 1800 and 2800 Series) must be ordered separately.

Inside Function

Opened by lever handle at all times.

Holdback Function

A key operated holdback function is available as a lock setting and requires the inclusion of an internal cylinder.

Selector® 3772 DX Digital Mortice Locks



Exterior



Interior

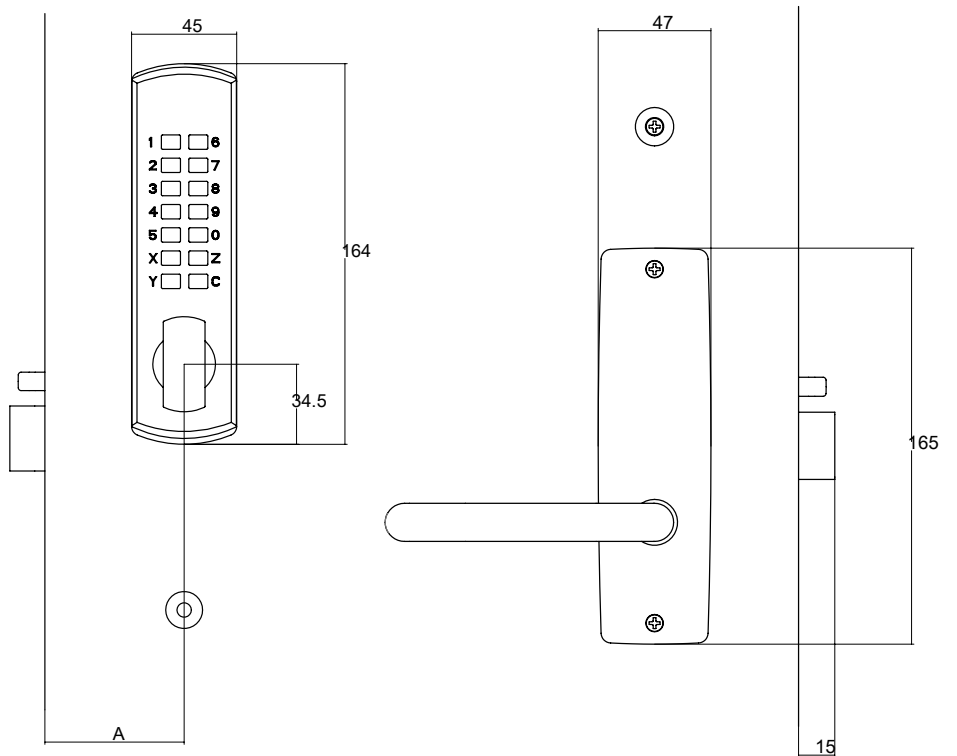

Selector® 3772 DX Digital Mortice Locks

| Part Number | 3772DX | 4772DX | 5772DX |
|-------------|--------|--------|--------|
| Dimension A | 60 | 89 | 127 |

Note: Order by specifying 3772SS primary lock and 3772-DXKITSC

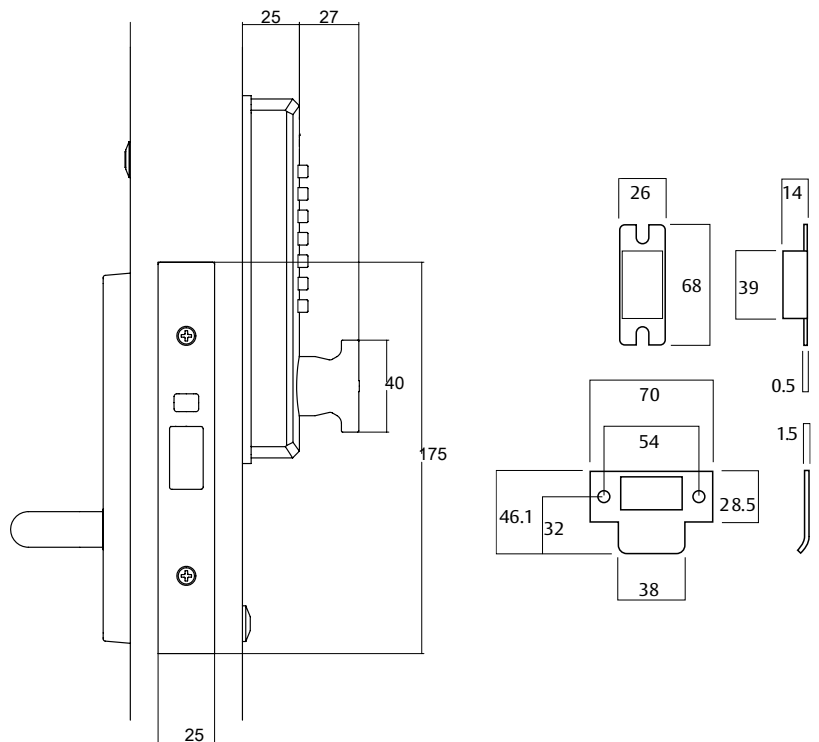

Selector® 3772 DX Digital Mortice Locks

DX Digital Mortice Lock

Part Number 3772DX-

DX Digital outside, plate furniture inside.

Outside: Opened by DX Digital with code.

Inside: Opened by handle at all times.

This function requires the locking bar to be positioned in the locked position once lock is set.

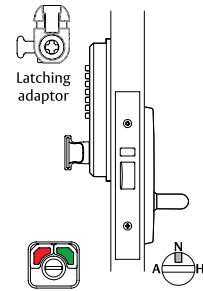

DX Digital Mortice Lock with Holdback by Cylinder#

Part Number 3772DXVH

DX Digital outside, plate furniture and cylinder inside.

Outside: Opened by DX Digital with code.

Inside: Opened by handle at all times. Holdback activated by key. Key retracts latch after releasing holdback.

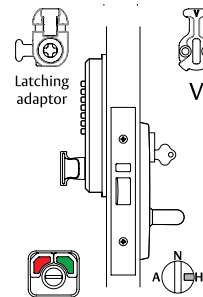

Notes:

All drawings shown are in right hand configuration. Part numbers shown above are for 60mm backset lock, if 89mm is required substitute 3 for 4 i.e. 4772, or if 127mm lock is required, substitute 3 for 5 i.e. 5772

#Holdback - Latch bolt can be held within the lock. **Holdback must not be activated on fire doors.**

For questions concerning our fire rated products, their specifications and their utilization please contact ASSA ABLOY or relevant Fire Door manufacturer.

Legend

Hub Setting



Lock Function Setting



Cam or Adaptor



Selector® 3772 Key Override DX Digital Mortice Locks



Description

Lockwood DX Digital Locksets provide a mechanical method of keyless entry and are designed to control access into commercial areas.

For extra security when under forced attack, the inbuilt clutching mechanism allows the outside turnknob to rotate without operating or damaging the lock.

The factory set 4 digit code is easily changed to any 4, 5 or 6 digit code using the code changing kit provided with each lock.

As the digital lockset utilizes mechanical operation, electrical wiring is not required.

Outside Function

Outside: Press the C button, enter the correct code, then turn the turnknob to unlock the door. Upon releasing the turnknob the code is automatically cancelled. The key override pin tumbler cylinder enables quick access by key for authorities such as the fire brigade or those who need to carry a master key to access all rooms of a building.

Product Details

| | |
|-----------------------|--|
| Backset | Available in 60, 89 and 127mm backsets. |
| Cylinder | Pin tumbler mechanism with oval brass cylinder |
| Door Thickness | 32mm to 50mm |
| Finish | Codepad: Satin Chrome Brushed (SC) Mortice Lock: Stainless Steel (SS) |
| Latch | Stainless steel with 15mm projection |

Door Furniture (Lockwood 1800 and 2800 Series) and lower cylinder must be ordered separately.

Inside Function

Opened by lever handle at all times.

Holdback Function

A key operated holdback function is available as a lock setting and requires the inclusion of an internal cylinder.

Selector® 3772 Key Override DX Digital Mortise Locks



Exterior



Interior

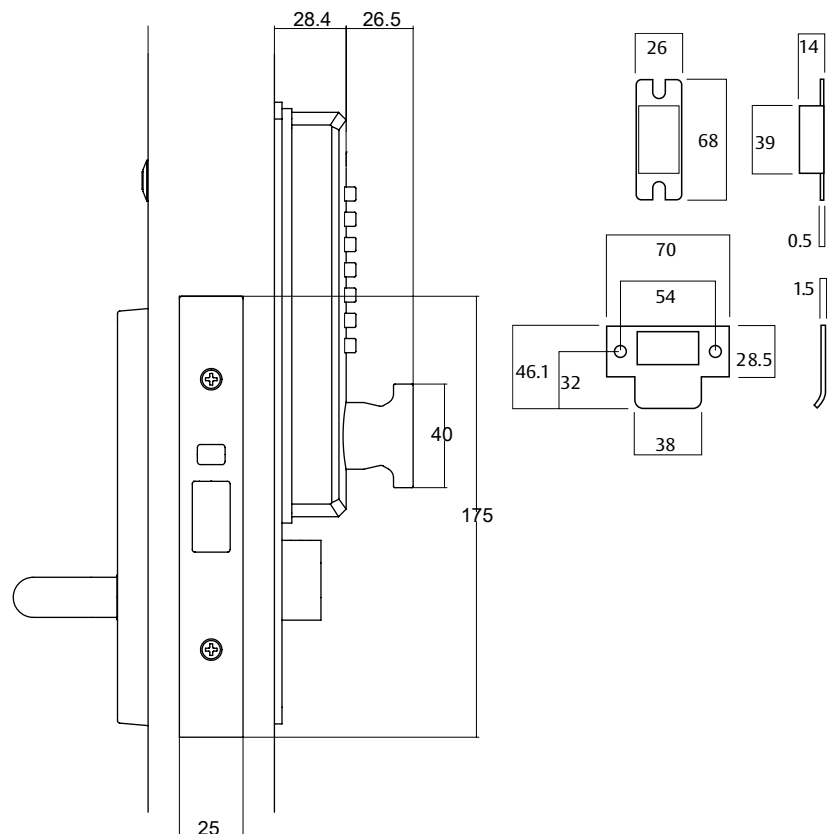
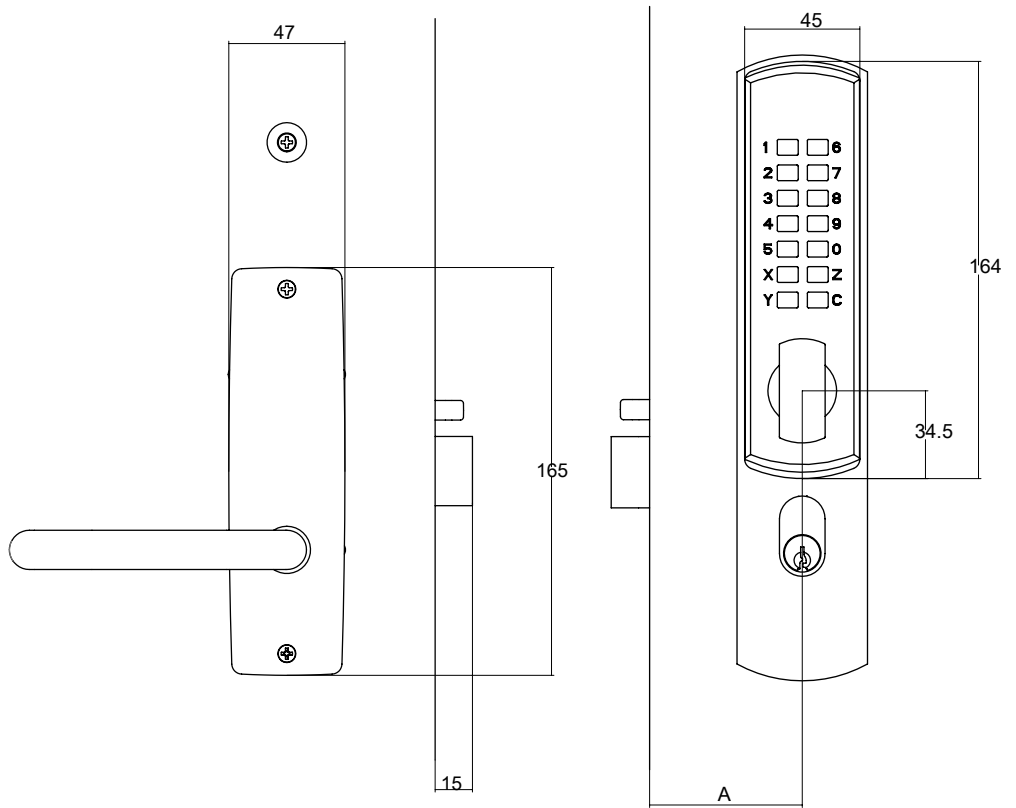

Selector® 3772 Key Override DX Digital Mortise Locks

| Part Number | 3772DXKO | 4772DXKO | 5772DXKO |
|-------------|----------|----------|----------|
| Dimension A | 60 | 89 | 127 |

Note: Order by specifying 3772SS primary lock and 3772-DXKOKITSC. Cylinders must be ordered separately.

Selector® 3772 Key Override DX Digital Mortise Locks

Key Override DX Digital Mortise Lock

Part Number 3772DXKO-

DX Digital and lower cylinder outside, plate furniture inside.
Outside: Opened by DX Digital with code or key at all times.

Inside: Opened by handle at all times.

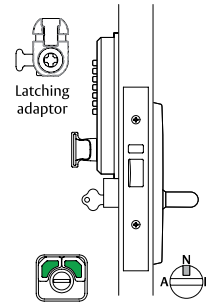

Key Override DX Digital Mortise Lock with Holdback by Cylinder#

Part Number 3772DXKOVH

DX Digital and lower cylinder outside, plate furniture and cylinder inside.

Outside: Opened by DX Digital with code or key at all times.

Inside: Opened by handle at all times. Holdback activated by key. Key retracts latch after releasing holdback.

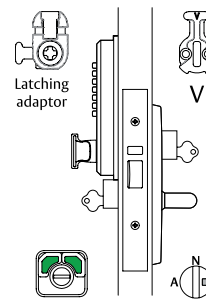

Notes:

All drawings shown are in right hand configuration.

Part numbers shown above are for 60mm backset lock, if 89mm is required substitute 3 for 4 i.e. 4772, or if 127mm lock is required, substitute 3 for 5 i.e. 5772

#Holdback - Latch bolt can be held within the lock. **Holdback must not be activated on fire doors.** For questions concerning our fire rated products, their specifications and their utilization please contact ASSA ABLOY or relevant Fire Door manufacturer.

| Legend | |
|-----------------------|--|
| Hub Setting | |
| Lock Function Setting | |
| Cam or Adaptor | |

Selector® 3770 Series Accessories

Dual Entry Kits

| Part Number | Application |
|--------------|--|
| 3777-KIT570E | For new 3777 dual entry applications |
| 3777-KIT577 | For Synergy 3577 retrofit applications |

Dual Entry kits include: Lower cylinder mounting plate, spindle cam and mounting screws. Retrofit kit does not include spindle cam.

Cylinders must be ordered separately.

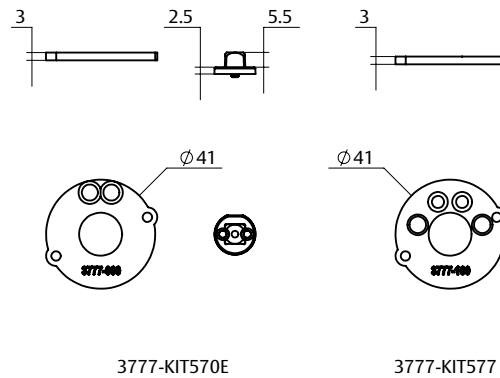

DX Digital Kits

| Part Number | Application |
|----------------|----------------------------------|
| 3772-DXKITSC | DX Digital Kit |
| 3772-DXKOKITSC | DX Digital with Key Override Kit |

DX Digital kits include: Digital codepad, mounting plate, codepad spindle, associated mounting screws and a latching adaptor.

Cylinders and door furniture (1800 or 2800 series) must be ordered separately.

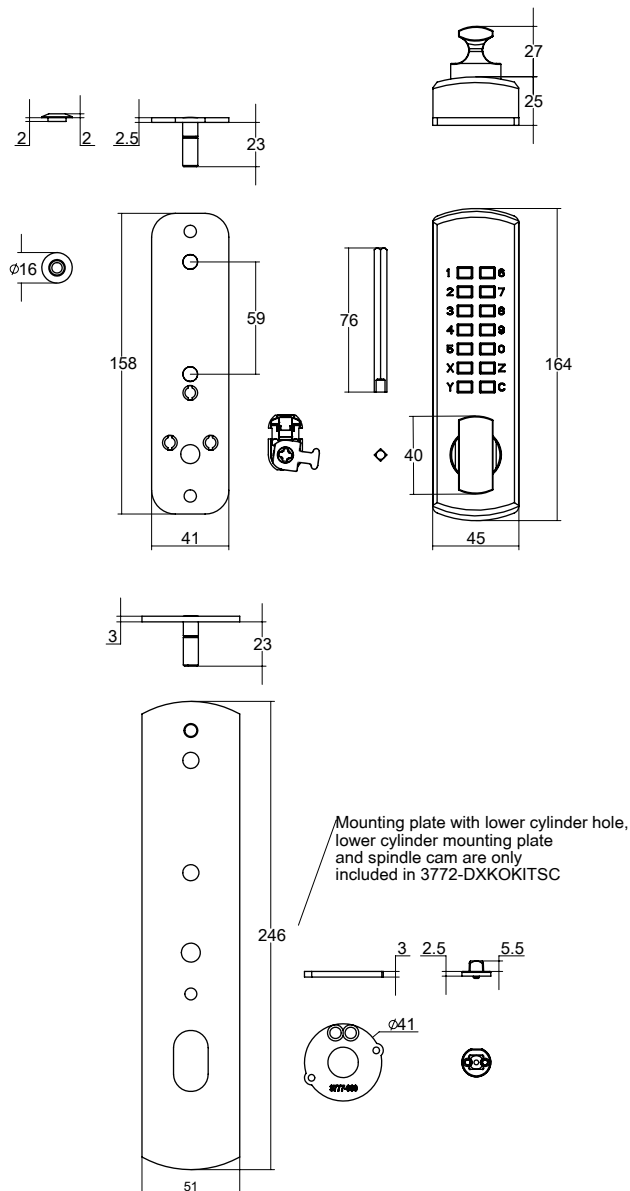

Selector® 3770 Series Accessories

Alternative Finish Kits

| Part Number | Finish |
|----------------|----------------|
| 3772-FINKITCP* | Chrome Plate |
| 3772-FINKITPB | Polished Brass |
| 3772-FINKITPC | Powder Coat |

Finish kits include: Strike, faceplate and screws.
 For 3774 Passage Latch, please specify 3774FINKITXX,
 where XX designates finish.
 *Screws not included.

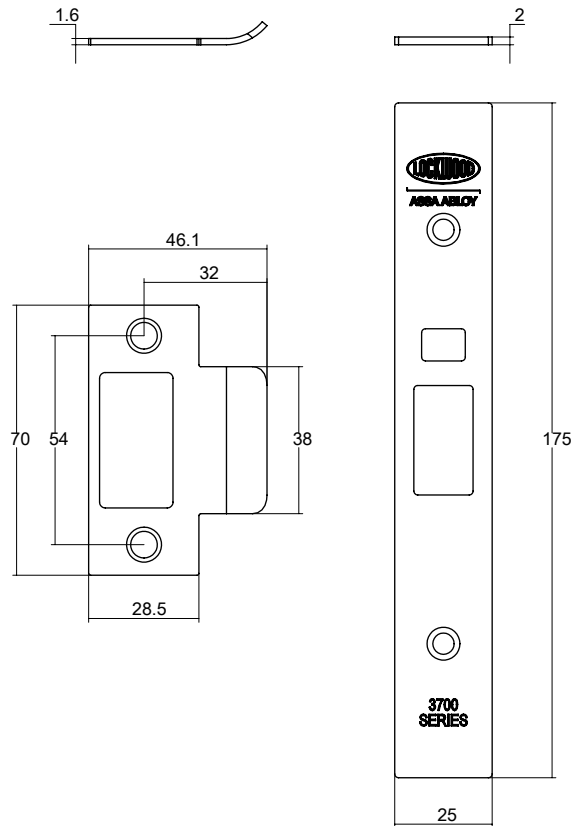

Fire Rated (4hr) Rebate Kits

| Part Number | Lip Length A |
|-------------|--------------|
| 3772-RK32XX | 32mm |
| 3772-RK46XX | 46mm |

Rebate kits to suit standard 13mm rebate.
 To order, add finish code to part number.
 XX designates finish.
SS - Stainless Steel, **CP** - Chrome Plate, **PB** - Polished Brass

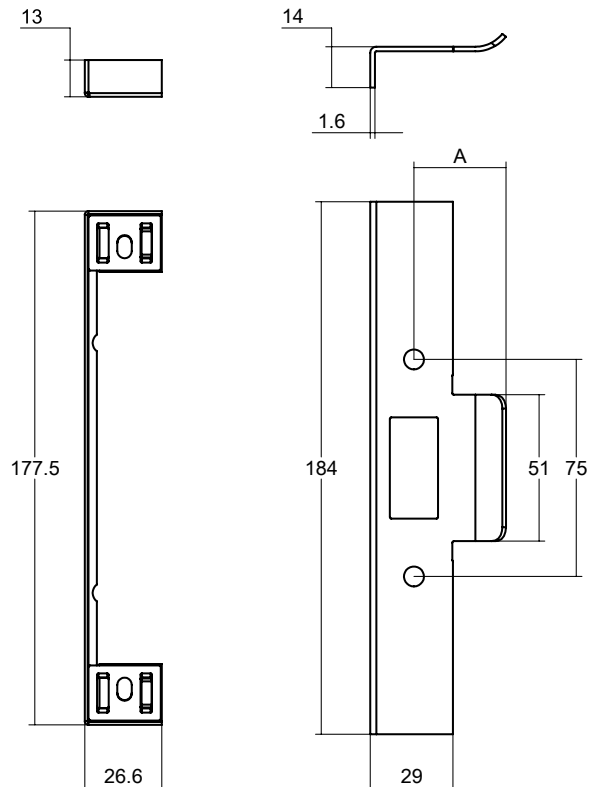

Notes:
 For questions concerning our fire rated products, their specifications and their utilization please
 contact ASSA ABLOY or relevant Fire Door Manufacturer.

Selector[®] 3770 Series Accessories

Aluminium Door Fixing Kit

| Part Number | Finish |
|---------------|-----------------|
| 3772-AFKITSS* | Stainless Steel |
| 3772-AFKITCP* | Chrome Plate |
| 3772-AFKITPC | Powder Coat |

For 3774 Passage Latch, please specify 3774-AFKITXX, where XX designates finish.

*Faceplate screws not included

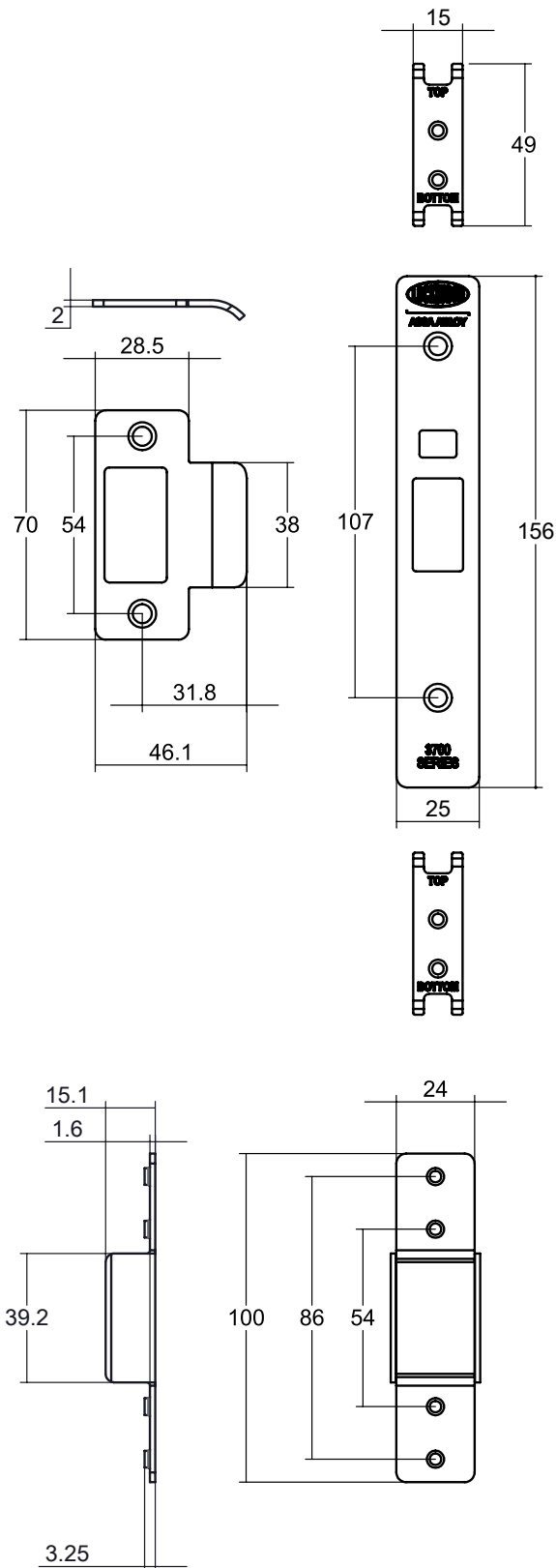

Selector[®] 3770 Series Accessories

Short/Extended Lipped Strikes

| Part Number | Lip Length A | Lip Length B |
|---------------|--------------|--------------|
| 3772-STK25XX | 25.4mm | 39.3mm |
| 3772-STK32XX | 32mm | 46.1mm |
| 3772-STK43XX | 43.5mm | 57.8mm |
| 3772-STK47XX | 47.5mm | 61.8mm |
| 3772-STK60XX* | 60mm | 74.2mm |

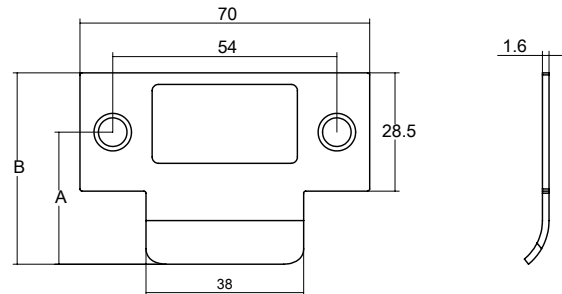

To order, add finish code to part number.

XX designates the finish.

SS - Stainless Steel, **CP** - Chrome Plate, **PB** - Polished Brass

*Only available in Stainless Steel (**SS**) finish.

ES2100 Electric Strike Faceplate

| Part Number | Application |
|----------------|--|
| 3772-2100SS | To suit 3770 Series |
| 3772AF-2100SS* | To suit 3770 Series with Aluminium Door Fixing |

To work in conjunction with the Lockwood Padde Series ES2100 electric strike for door position monitoring.

* Can be used directly with a 3772SS primary lock

- No additional AF fixing kit is required.

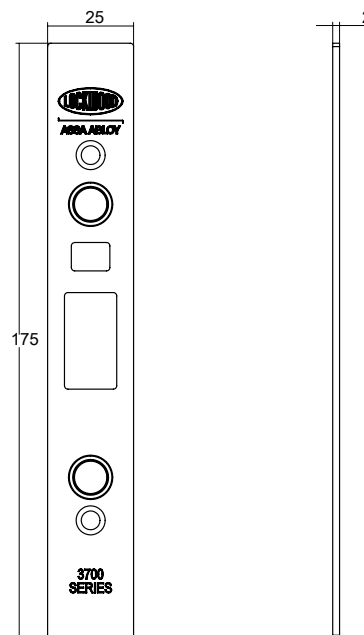

Security Faceplate Screw Kit

| Part Number | Application |
|-------------|---------------------|
| 3772-SECKIT | To suit 3770 Series |

Kit contains two replacement faceplate screws with tamper resistant TR20 torx drive heads.

Selector[®] 3770 Series Accessories

Mortice Lock Spindles

| Part Number | Pack Size | Length "A" | Door Thickness | |
|-------------|-----------|------------|----------------|-----|
| | | | Min | Max |
| SP3570-5018 | 10 | 33mm | 32 | 50 |
| SP3570-5228 | 1 | 45mm | 50 | 75 |
| SP3570-5238 | 1 | 58mm | 75 | 100 |
| SP3570-5258 | 1 | 108mm | 100 | 200 |

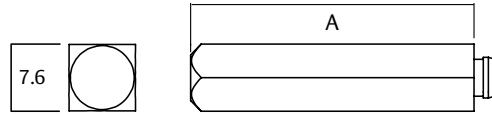

Single Cylinder Assemblies

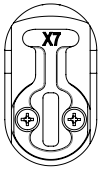

"X7" Cam Cylinder
570C4/X7

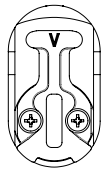

"V" Cam Cylinder
570C4/V



3777 Lower Cylinder
with Spindle Cam
570EC4/77

Cylinder Cams

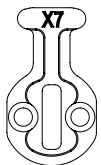

"X7" Cam
SP3700/X7CAM

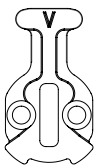

"V" Cam
SP3700/VCAM

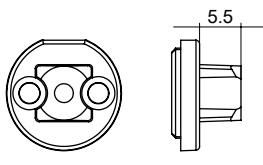

3777 Spindle Cam
SP3777/CAM

Adaptors

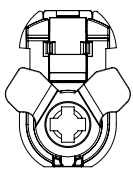

Locking Adaptor
3772-ADAPTOR

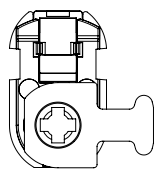

Latching Adaptor
3770-ADAPTOR

Selector® 3770 Series Cam and Adaptors Function Chart

Selector® 3770 Series Cam and Adaptors Function Chart

| Selector® 3770 Series | Function Description | Primary Lock | Outside Cylinder Cam/Adaptor | Inside Cylinder Cam/Adaptor | Kit |
|---|---|--------------|------------------------------|-----------------------------|--------------|
| Selector® 3770 Nightlatches | | | | | |
| 3770SS | Nightlatch Primary Lock | 3770SS | - | - | |
| 3770-TSS | Nightlatch with Turn | 3770TSS | - | 3770-ADAPTOR | |
| 3770X-SS | Nightlatch with Cylinder | 3770SS | X7 | - | |
| 3770XTSS | Nightlatch with Cylinder and Turn | 3770TSS | X7 | 3770-ADAPTOR | |
| 3770XXSS | Nightlatch with Double Cylinder | 3770SS | X7 | X7 | |
| Selector® 3772 Escape Locks | | | | | |
| 3772SS | Escape Primary Lock | 3772SS | - | - | |
| 3772-SS | Escape Lock | 3772SS | - | - | |
| 3772V-SS | Anti-vandal Escape Lock | 3772SS | V | - | |
| 3772VTSS | Anti-vandal Escape Lock with Turn | 3772TSS | V | 3772-ADAPTOR | |
| 3772X-SS | Key Entry Escape Lock | 3772SS | X7 | - | |
| 3772XTSS | Key Entry Escape Lock with Turn | 3772TSS | X7 | 3772-ADAPTOR | |
| 3772-VSS | Escape Lock with Internal Cylinder | 3772SS | - | V | |
| 3772-TSS | Escape Lock with Turn | 3772TSS | - | 3772-ADAPTOR | |
| 3772VSS | Anti-vandal Escape Lock with Internal Cylinder | 3772SS | V | V | |
| 3772XVSS | Key Entry Escape Lock with Internal Cylinder | 3772SS | X7 | V | |
| 3772-TASS | Anti-lockout Escape Lock with Turn | 3772TSS | - | 3772-ADAPTOR | |
| 3772VTASS | Anti-lockout Anti-vandal Escape Lock with Turn | 3772TSS | V | 3772-ADAPTOR | |
| 3772V-HSS | Holdback Anti-vandal Escape Lock | 3772SS | V | - | |
| 3772VTHSS | Holdback Anti-vandal Escape Lock with Turn | 3772TSS | V | 3772-ADAPTOR | |
| 3772XVHSS | Holdback Key Entry Escape Lock with Internal Cylinder | 3772SS | X7 | V | |
| Selector® 3774 Passage Latch | | | | | |
| 3774SS | Passage Latch | 3774SS | - | - | |
| Selector® 3774 Combination Locks | | | | | |
| 3774VTSS | Anti-vandal Lock with Turn | 3772TSS | V | 3772-ADAPTOR | |
| 3774VSS | Anti-vandal Lock with Internal Cylinder | 3772SS | V | V | |
| 3774XVSS | Key Entry Lock with Internal Cylinder | 3772SS | X7 | V | |
| 3774XXSS | Key Entry Double Cylinder Lock | 3772SS | X7 | X7 | |
| 3774-TSS | Combination Lock with Turn | 3772TSS | - | 3772-ADAPTOR | |
| 3774-TASS | Anti-lockout Combination Lock with Turn | 3772TSS | - | 3772-ADAPTOR | |
| 3774VTASS | Anti-lockout Anti-vandal Lock with Turn | 3772TSS | V | 3772-ADAPTOR | |
| 3774VASS | Anti-lockout Anti-vandal Lock with Internal Cylinder | 3772SS | V | V | |
| 3774VTHSS | Holdback Anti-vandal Lock with Turn | 3772TSS | V | 3772-ADAPTOR | |
| 3774VVHSS | Holdback Anti-vandal Lock with Internal Cylinder | 3772SS | V | V | |
| 3774XVHSS | Holdback Key Entry Lock with Internal Cylinder | 3772SS | X7 | V | |
| Selector® 3777 Dual Entry Locks | | | | | |
| 3777X-SS | Dual Entry Lock | 3772SS | X7, 3777 SPINDLE CAM | - | 3777-KIT570E |
| 3777V-SS | Dual Entry Lock with Lower Cylinder Lockout | 3772SS | V, 3777 SPINDLE CAM | - | 3777-KIT570E |

Selector® 3770 Series Cam and Adaptors Function Chart

Selector® 3770 Series Cam and Adaptors Function Chart

| Selector® 3770 Series | Function Description | Primary Lock | Outside Cylinder Cam/Adaptor | Inside Cylinder Cam/Adaptor | Kit |
|--|--|--------------|--------------------------------|-----------------------------|----------------|
| Privacy Locks | | | | | |
| 3772-TSS | Escape Privacy Lock | 3772TSS | - | 3772-ADAPTOR | |
| 3772-TASS | Anti-lockout Escape Privacy Lock | 3772TSS | - | 3772-ADAPTOR | |
| 3774-TSS | Privacy Lock | 3772TSS | - | 3772-ADAPTOR | |
| 3774-TASS | Anti-lockout Privacy Lock | 3772TSS | - | 3772-ADAPTOR | |
| 3777-TSS | Key Entry Privacy Lock | 3772TSS | 3777 SPINDLE CAM | 3772-ADAPTOR | 3777-KIT570E |
| 3777-TASS | Key Entry Anti-lockout Privacy Lock | 3772TSS | 3777 SPINDLE CAM | 3772-ADAPTOR | 3777-KIT570E |
| Selector® 3772 DX Digital Locks | | | | | |
| 3772DX-SS | DX Digital Mortice Lock | 3772SS | 3770-ADAPTOR | - | 3772-DXKITSC |
| 3772DXVHSS | DX Digital Mortice Lock with Holdback by Cylinder | 3772SS | 3770-ADAPTOR | V | 3772-DXKITSC |
| 3772DXKO-SS | Key Override DX Digital Mortice Lock | 3772SS | 3770-ADAPTOR, 3777 SPINDLE CAM | - | 3772-DXKOKITSC |
| 3772DXKOVHSS | Key Override DX Digital Mortice Lock with Holdback by Cylinder | 3772SS | 3770-ADAPTOR, 3777 SPINDLE CAM | V | 3772-DXKOKITSC |

Notes: Items in Italics are Primary locks and can be purchased from ASSA ABLOY. Purchased configurations include adaptors as required. Cylinders must be ordered separately.

Synergy Series Conversion Chart

Synergy Series Conversion Chart

| Synergy Series | Selector® 3770 Series | Function Description | Note |
|--------------------------|-----------------------|---|--|
| Nightlatches | | | |
| 3570SC | 3770SS | Nightlatch Primary Lock | |
| 3570-T#SC | 3770-TSS | Nightlatch with Turn | |
| 3570X-#SC | 3770X-SS | Nightlatch with Cylinder | |
| 3570XT#SC | 3770XTSS | Nightlatch with Cylinder and Turn | |
| 3570XX#SC | 3770XXSS | Nightlatch with Double Cylinder | |
| Escape Locks | | | |
| 3572SC | 3772SS | Escape Primary Lock | |
| 3572EA#SC | 3772-TASS | Anti-lockout Escape Privacy Lock | |
| 3572M-#SC | 3772V-SS | Anti-vandal Escape Lock | V cam has the functionality of locking lock and retracting bolt without an adaptor. |
| 3572-T#SC | 3772-TSS | Escape Lock with Turn | |
| 3572WA#SC | 3772VTASS | Anti-lockout Anti-vandal Escape Lock with Turn | V cam has the functionality of locking lock just as the W cam. V cam also retracts bolt after unlocking lock. |
| 3572WT#SC | 3772VTSS | Anti-vandal Escape Lock with Turn | V cam has the functionality of locking lock just as the W cam. V cam also retracts bolt after unlocking lock. |
| 3572X-#SC | 3772X-SS | Key Entry Escape Lock | X7 cam has the functionality of retracting bolt and locking lock. Does not have unlocking functionality. |
| 3572XA#SC | 3772VTASS | Anti-lockout Anti-vandal Escape Lock with Turn | V cam has the functionality of locking lock and retracting bolt without an adaptor. |
| 3572XT#SC | 3772XTSS | Key Entry Escape Lock with Turn | X7 cam has the functionality of retracting bolt and locking lock. Does not have unlocking functionality. |
| 3572XZ#SC | 3772XVSS | Key Entry Escape Lock with Internal Cylinder | V cam has the functionality of locking lock just as the Z cam. V cam also retracts bolt after unlocking lock. X7 cam has the functionality of retracting bolt and locking lock. Does not have unlocking functionality. |
| 3572-Z#SC | 3772-VSS | Escape Lock with Internal Cylinder | V cam has the functionality of locking lock just as the Z cam. V cam also retracts bolt after unlocking lock. |
| 3572Z-#SC | 3772V-SS | Anti-vandal Escape Lock | V cam has the functionality of locking lock just as the Z cam. V cam also retracts bolt after unlocking lock. |
| Combination Locks | | | |
| 3574SC | 3774SS | Passage Latch | |
| 3574ET#SC | 3774-TSS | Privacy Lock | |
| 3574WT#SC | 3774VTSS | Anti-vandal Lock with Turn | V cam has the functionality of locking lock just as the W cam. V cam also retracts bolt after unlocking lock. |
| 3574XX#SC | 3774XXSS | Key Entry Double Cylinder Lock | X7 cam has the functionality of retracting bolt and locking lock. Does not have unlocking functionality. |
| 3574XZ#SC | 3774XVSS | Key Entry Lock with Internal Cylinder | V cam has the functionality of locking lock just as the Z cam. V cam also retracts bolt after unlocking lock. X7 cam has the functionality of retracting bolt and locking lock. Does not have unlocking functionality. |
| 3574-Z#SC | 3774-VSS | Combination Lock with Internal Cylinder | V cam has the functionality of locking lock just as the Z cam. V cam also retracts bolt after unlocking lock. |
| 3574Z-#SC | 3774V-SS | Anti-vandal Combination Lock | V cam has the functionality of locking lock just as the Z cam. V cam also retracts bolt after unlocking lock. |
| 3574ZZ#SC | 3774VSS | Anti-vandal Lock with Internal Cylinder | V cam has the functionality of locking lock just as the Z cam. V cam also retracts bolt after unlocking lock. |
| Dual Entry Locks | | | |
| 3577SC | | | 3772SS primary lock can be converted to a dual entry lock with the 3777-KIT570E kit. |
| 3577EA#SC | 3777-TASS | Key Entry Anti-lockout Privacy Lock | |
| 3577M-#SC | 3777V-SS | Dual Entry Lock with Lower Cylinder Lockout | V cam has the functionality of locking lock and retracting bolt without an adaptor. |
| 3577X-#SC | 3777X-SS | Dual Entry Lock | X7 cam has the functionality of retracting bolt and locking lock. Does not have unlocking functionality. |
| Holdback Locks | | | |
| 3578SC | | | Holdback functionality is available in 3772 primary lock. |
| 3578M-#SC | 3772V-HSS | Holdback Anti-vandal Escape Lock | V cam has the functionality of locking lock and retracting bolt without an adaptor. |
| 3578WT#SC | 3772VTHSS | Holdback Anti-vandal Escape Lock with Turn | V cam has the functionality of locking lock just as the W cam. V cam also retracts bolt after unlocking lock. |
| 3578Z-#SC | 3772V-HSS | Holdback Anti-vandal Escape Lock | V cam has the functionality of locking lock just as the Z cam. V cam also retracts bolt after unlocking lock. |
| 3578XZ#SC | 3772XVHSS | Holdback Key Entry Escape Lock with Internal Cylinder | V cam has the functionality of locking lock just as the Z cam. V cam also retracts bolt after unlocking lock. X7 cam has the functionality of retracting bolt and locking lock. Does not have unlocking functionality. |

Synergy Series Conversion Chart

Synergy Series Conversion Chart

| Synergy Series | Selector® 3770 Series | Function Description | Note |
|-----------------------------|-----------------------|---|------|
| Extended Lip Strikes | | | |
| SP3570-4053SSS | 3772-STK25SS | 3772 SHORT LIP STRIKE 25.4MM LIP | |
| SP3570-4153CP | 3772-STK25CP | 3772 SHORT LIP STRIKE 25.4MM LIP | |
| SP3570-4153PB | 3772-STK25PB | 3772 SHORT LIP STRIKE 25.4MM LIP | |
| SP3570-5053SSS | 3772-STK32SS | 3772 STANDARD STRIKE 32MM LIP PK=10 | |
| SP3570-5153CP | 3772-STK32CP | 3772 STANDARD STRIKE 32MM LIP PK=10 | |
| SP3570-5153PB | 3772-STK32PB | 3772 STANDARD STRIKE 32MM LIP PK=10 | |
| SP3570-5253SSS | 3772-STK43SS | 3772 LONG LIP STRIKE 43.5MM LIP | |
| SP3570-5353CP | 3772-STK43CP | 3772 LONG LIP STRIKE 43.5MM LIP | |
| SP3570-5353PB | 3772-STK43PB | 3772 LONG LIP STRIKE 43.5MM LIP | |
| SP3570-5453SSS | 3772-STK47SS | 3772 LONG LIP STRIKE 47MM LIP | |
| SP3570-5653CP | 3772-STK47CP | 3772 LONG LIP STRIKE 47MM LIP | |
| SP3570-5653PB | 3772-STK47PB | 3772 LONG LIP STRIKE 47MM LIP | |
| SP3570-5960SS | 3772-STK60SS | 3772 LONG LIP STRIKE 60MM LIP | |
| SP500-252ZP | 3772-STKBOX | 3772 STRIKE BOX PK=10 | |
| Rebate Kits | | | |
| 3P72-RK32SS | 3772-RK32SS | 3772 SERIES REBATE KIT- 32MM LIP STRIKE | |
| 3P72-RK32CP | 3772-RK32CP | 3772 SERIES REBATE KIT- 32MM LIP STRIKE | |
| 3P72-RK32PB | 3772-RK32PB | 3772 SERIES REBATE KIT- 32MM LIP STRIKE | |
| 3P72-RK46SS | 3772-RK46SS | 3772 SERIES REBATE KIT- 46MM LIP STRIKE | |
| 3P72-RK46CP | 3772-RK46CP | 3772 SERIES REBATE KIT- 46MM LIP STRIKE | |
| 3P72-RK46PB | 3772-RK46PB | 3772 SERIES REBATE KIT- 46MM LIP STRIKE | |

Selector® 3770 Series Cylinder Mortice Locks Functioning Matrix

Functioning Matrix

Sample part number 3772VTASS is made up of seven elements.

The description of this part number is an Anti-lockout Anti-vandal escape lock with cylinder and turn in satin stainless steel finish. Choose your product by selecting an option from each element.

| Backset | Series | Platform | Function | Sub Function | Lock Function Setting | Finish |
|---------|--------|----------|----------|--------------|-----------------------|--------|
| 3 | 7 | 7 | 2 | VT | A | SS |

| Backset | Sub Function | Lock Function Setting |
|---------|---|-----------------------|
| 60mm 3 | e.g. Outside Inside V T | Neutral |
| 89mm 4 | Locking and Latching Cylinder with V Cam V | Anti-lockout A |
| 127mm 5 | Latching Cylinder with X7 Cam X | Holdback H |

| Series | Sub Function | Finish |
|-------------------------------------|----------------------|--------------------|
| Selector® Series Mortice Locks 7 | Turnbutton Adaptor T | Stainless Steel SS |
| | No Sub Function - | |

| Platform | Sub Function |
|--------------------|--------------------------------------|
| Standard Backset 7 | DX Digital DX |
| | DX Digital with Key Override DXKO |

| Functions | Sub Function |
|--------------------|--------------|
| Nightlatch 0 | |
| Escape Lock 2 | |
| Combination Lock 4 | |
| Dual Entry Lock 7 | |

Code

1. Backset: Nominate backset as required, for example 3 = 60mm backset.

2. Function: Select function, for example 772 = Escape Lock

3. Sub Function: Determine sub function requirements for both exterior and interior.

For example:

Exterior – Locking function required – specify V (cylinder).

Interior – Turnknob function required – specify T

(turnbutton adaptor).

4. Locking Function Setting: Determine lock function requirements.

For example:

Anti-lockout - Specify A

5. Finish: Select appropriate finish, e.g. SS

Other finishes available by specifying finish kits.



Selector® 3780 Series Mortice Locks

Selector® 3780 Series Cylinder Mortice Locks

A comprehensive range of cylinder mortice locks for narrow stile hinged doors, suitable for heavy duty use in industrial and commercial buildings, shop fronts, clubs, schools, hospitals, hotels and similar buildings.

Benefits

- Easy red/green function setting
- All lock settings are made from under the faceplate allowing for simple in-door configuration
- Standard primary locks include anti-lockout and holdback capabilities
- Improved cylinder functions including lock/unlock and retract latch as standard
- Reduced range of cylinder cams and turn adaptors relative to other commonly available commercial cylinder mortice locks

Features and Specifications

The Australian designed and made Selector® 3780 Series Short Backset Cylinder Mortice Locks are made from quality materials to meet high durability and strength requirements.

Case and Faceplates

- High purity zinc alloy material cases with stainless steel chassis plates. Stainless steel faceplates provided as standard.
- Brass faceplates are available for alternative finishes

Backset

23mm standard backset. Extended backsets 25.4mm, 30mm and 38mm are available, refer to function matrix (Page 76)

Latch Bolts

- Latch bolts are made with stainless steel, 15mm in size
- Deadlatching is achieved by an auxiliary stainless steel latch bolt
- Reversible for both left and right hand doors, opening in or opening out whilst lock is in door
- Electric strike compatibility
- Separate auxiliary bolt moves into lock case simultaneously with latch bolt
- Radius bolt provides greater deadlatch throw and smoother closing action

Cylinder Retaining Pin

- Hard-drawn spring steel wire, corrosion protected

Door Thickness

- Metal doors: 35 to 50mm
- Suits hollow-style aluminium door sections with 38mm minimum internal depth
- Timber doors: 32 to 50mm
- Specify 3782-TFKIT for timber door fixing kit to convert an aluminium fix lock suit timber door fixing. The timber door fixing kit includes a long faceplate, strike and screws to suit a timber door and jamb

Cylinder

Requires standard Lockwood oval shaped brass cylinders and brass barrels. Lockwood cylinders include bump resistant five pin tumbler mechanism.

Functions require the use of different cams and adaptors.

Keying

Restricted Special Keying

Lockwood locks can be keyed to a number of controlled and/or specially keyed systems. These range from legally protected keys to protect against unauthorised duplication and can also include specially designed keying systems such as master key systems. This allows for different levels of mechanical access control.

Please refer to assaabloy.com.au for keying systems or contact your local sales office or customer service for specific information.

Security

All Selector® 3780 Series Cylinder Mortice Locks conform with Level S7 (Physical Security) Australian Lock Standard (AS-4145.2-2008). Conforms to Level S8 (Physical Security) when fitted with door furniture and anti-drill cylinder.

Durability

All Selector® 3780 Series Cylinder Mortice Locks conform with Level D8 (Durability) Australian Lock Standard (AS 4145.2-2008).

Anti-Corrosion

All Selector® 3780 Series Cylinder Mortice Locks conform with Level C6 (168 hours) Australian Lock Standard (AS4145.2-2008).

Door Clearance

To ensure correct functioning of the deadlatching mechanism and security for all locks, the clearance between the door and frame should be no less than 3mm. The deadlatching will operate up to 8mm door clearance, however door clearances over 5mm are not recommended.

Standard Finishes

Stainless Steel SS

Extended Cylinders

Modular cylinder extensions are available for thicker doors.

Rebate

Rebate kits to suit 13mm standard rebate are available. Only suitable for use with 30mm and 38mm backset locks.

Electric Strikes

Lockwood offers a wide range of electric strikes which are compatible with the Selector® 3780 Series Mortice Lock.

For further details refer to lockweb.com.au

S7 HIGH SECURITY

D8 DURABILITY

ANTI-CORROSION

Selector® 3780 Series Cylinder Mortice Locks

1. Multi-function Lock

The new Selector® 3780 Series Mortice Lock was designed to incorporate the full range of lock functions into one primary lock. This reduces stock line items. All functions can be configured by adjusting the hub setting selector, anti-lockout selector as well as using cylinder cams and turn adaptors.

2. Hub Setting Selection

Hub settings can be adjusted via the Selector® 3780 series hub selector located under the faceplate of the mortice lock. The hub setting allows for three functions: Passage, Combination, or Escape function. This is done by rotating the dial with a 4mm flat blade screwdriver.

RED - Handle is lockable. Only opened by handle when locking bar is unlocked (up).

GREEN - Opened by handle at all times.

3. Anti-lockout Selection

Anti-lockout function can now be selected via a switch under the faceplate of the mortice lock. This is done by depressing on the anti-lockout indicated part of the switch with a 4mm flat blade screwdriver. Clearance between door and frame should not be over 5mm to ensure anti-lockout mechanism functions correctly.

4. Case Assembly

Zinc diecast body with stainless steel chassis plates for improved strength.

5. Backsets

- Standard Backset - 23mm

Extended backsets 25.4, 30 and 38mm are available (Refer to Ordering Procedure on page 79)

6. Cylinder/Adaptor Retention

"Slip Pin" Cylinder/Adaptor fixing method, which allows attachment to the lock case by inserting a non-threaded cylindrical pin through the front of the lock case.

7. Cylinder Assembly

Five pin tumbler mechanism. Standard Lockwood oval shaped, brass cylinders and brass barrels. Only two newly designed cams needed for all lock functions.

X7 Cam - Retracts latch bolt with additional ability of locking the locking bar.

V Cam - Locks and unlocks the locking bar. Also retracts latch bolt after unlocking lock.

8. Synergy Retrofit

The Selector® 3780 Series Mortice Lock is designed to have an equivalent case size as the Synergy Series Mortice Lock to ensure retrofitability.

9. Lock Fixing and Kits

The Selector® 3780 Series primary lock is designed for aluminium doors. Various kit conversions are available for timber door applications, alternative finishes as well as dual entry and DX digital locksets.

Holdback Function

Lock is always holdback capable, no setting is required. Holdback can be activated at any time - unless anti-lockout is selected.

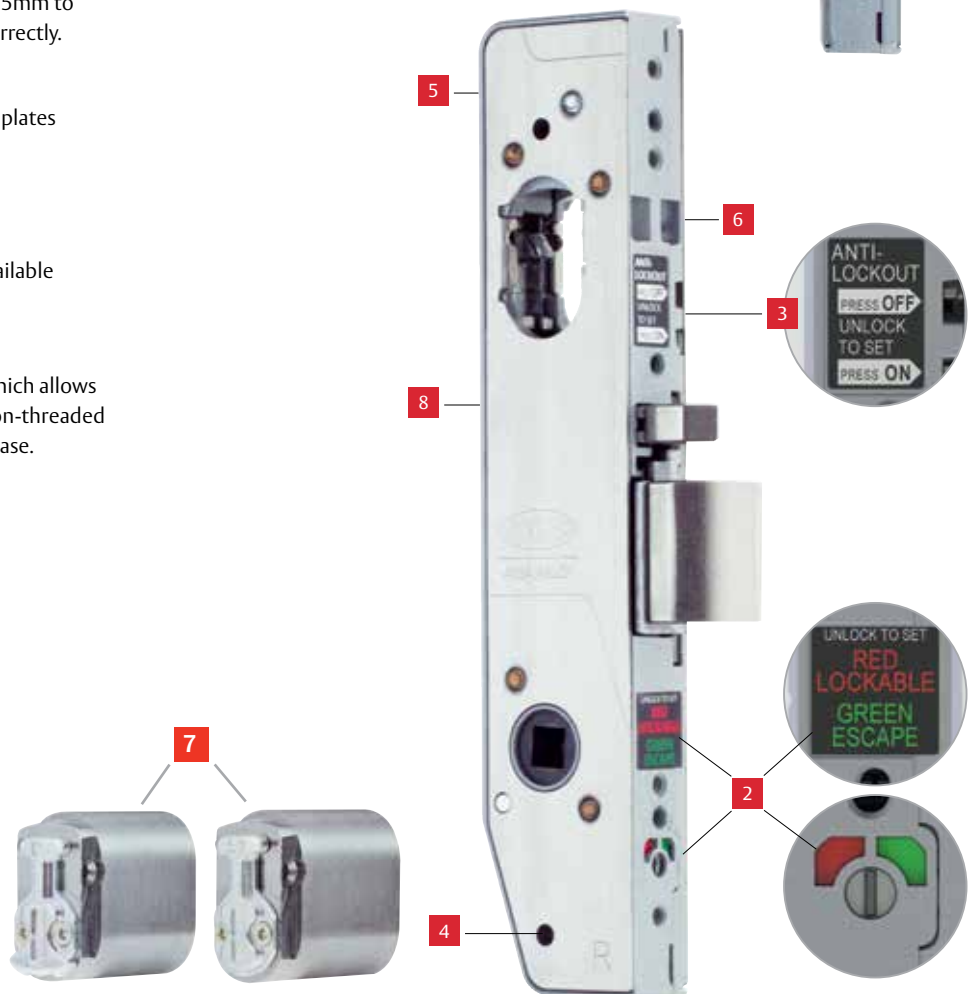

Selector® 3782 Short Backset Escape Locks



Description

These locks have various latching functions operated generally by key or handle outside and by turnknob, key or handle inside. These locks comply with building regulations for single-action escape doors.

Product Details

| | |
|--------------------------|---|
| Furniture | Compatible with Lockwood 4800 and 5800 Series Furniture. Refer to lockweb.com.au for further details. |
| Latch | Deadlatch only. |
| Standard Finishes | Stainless Steel (SS) Other finishes available via finish kit conversions. |

Selector® 3782 Short Backset Escape Locks

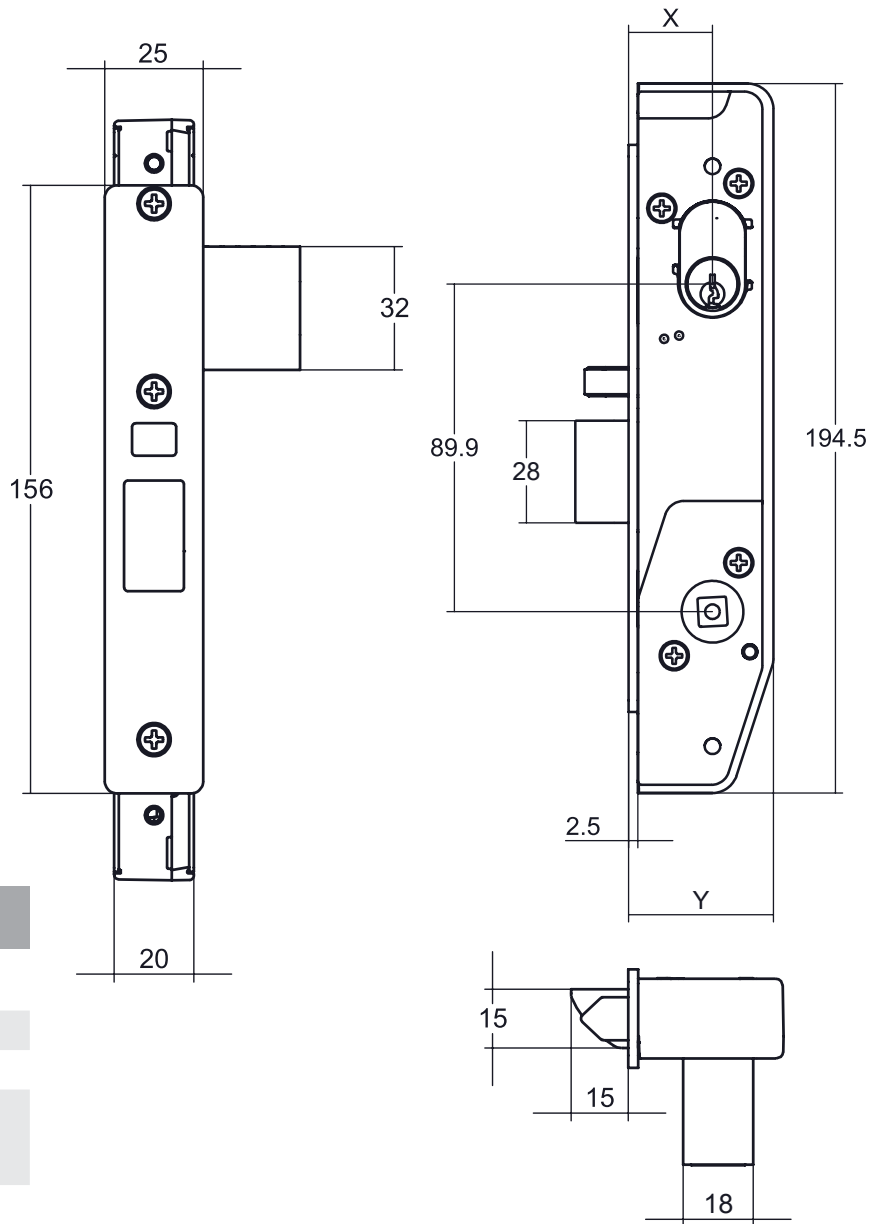

Selector® 3782 Short Backset Escape Locks

| Part Number | 3782 | 4782 | 5782 | 6782 |
|--------------------------------|------|------|------|------|
| Dimension X | 23 | 25.4 | 30 | 38 |
| Dimension Y | 40 | 42.4 | 47 | 55 |
| Minimum internal depth of door | 40 | 43 | 47 | 55 |

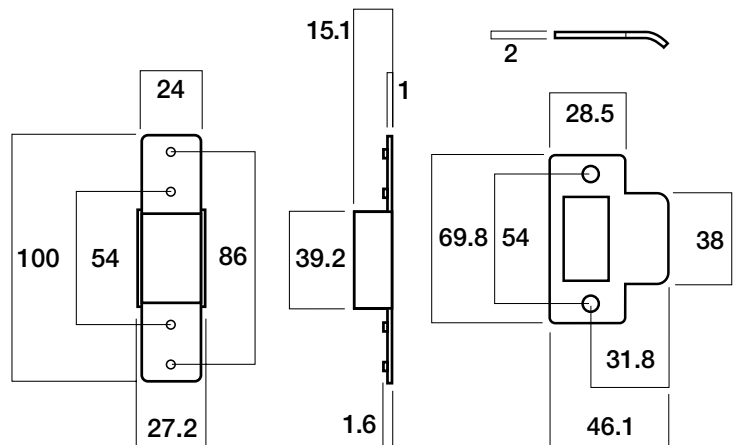

Selector® 3782 Short Backset Escape Locks

Escape Lock

Part Number 3782--

Outside: Handle always rigid.

Inside: Opened by handle at all times

This function requires the locking bar to be positioned in the locked position once lock is set.

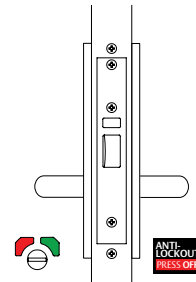

Anti-vandal Escape Lock[#]

Part Number 3782V-

Single cylinder.

Outside: Opened by handle when unlocked. Key locks or unlocks outside handle and retracts bolt after unlocking lock.

Inside: Opened by handle at all times.

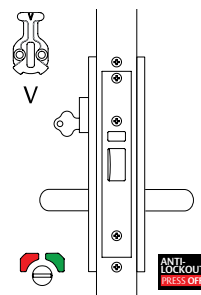

Anti-vandal Escape Lock with Turn[#]

Part Number 3782VT

Cylinder and turnknob.

Outside: Opened by handle when unlocked. Key locks or unlocks outside handle and retracts bolt after unlocking lock.

Inside: Opened by handle at all times. Turnknob locks or unlocks outside handle.

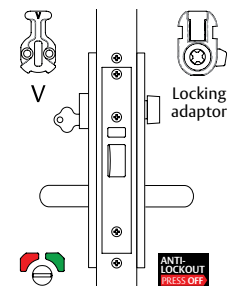

Key Entry Escape Lock

Part Number 3782X-

Single cylinder.

Outside: Opened by key at all times. Handle always rigid.

Inside: Opened by handle at all times.

This function requires the locking bar to be positioned in the locked position once lock is set.

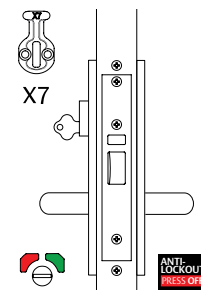

Notes:

All drawings shown are in right hand configuration. Part numbers shown above are for 23mm backset lock, if 25.4mm is required substitute 3 for 4 i.e. 4782, or if 30mm or 38mm lock is required, substitute 5 for 5 or 6 respectively i.e. 5782, 6782

*Anti-lockout - Closing the door or retracting latch bolt unlocks the lock, preventing lockout situations.

#Latch bolt can be held within the lock. Lock function recommended for use in holdback application.

Legend

Hub Setting



Anti-lockout Selection



Cam or Adaptor



Selector® 3782 Short Backset Escape Locks

Key Entry Escape Lock with Turn#

Part Number 3782XT

Cylinder and turnknob.

Outside: Opened by key at all times. Opened by handle when unlocked. Key locks outside handle.

Inside: Opened by handle at all times. Turnknob locks or unlocks outside handle.

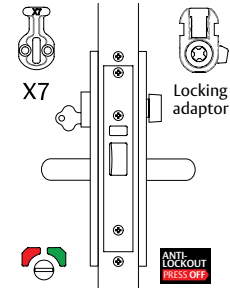

Escape Lock with Internal Cylinder#

Part Number 3782-V

Cylinder inside.

Outside: Opened by handle when unlocked.

Inside: Opened by handle at all times. Cylinder locks or unlocks outside handle and retracts bolt after unlocking lock.

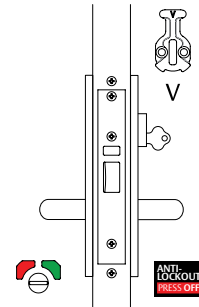

Escape Lock with Turn#

Part Number 3782-T

Turnknob inside.

Outside: Opened by handle when unlocked.

Inside: Opened by handle at all times. Turnknob locks or unlocks outside handle.

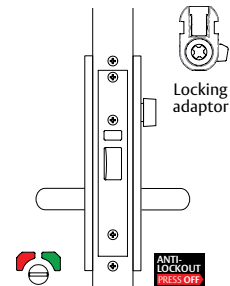

Key Entry Escape Lock with Internal Cylinder#

Part Number 3782XV

Double Cylinder.

Outside: Opened by key at all times. Opened by handle when unlocked. Key locks outside handle.

Inside: Opened by handle at all times. Key locks or unlocks outside handle and retracts bolt after unlocking lock.

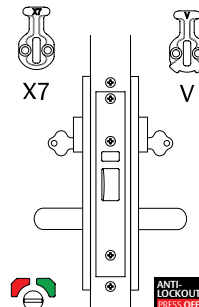

Notes:

All drawings shown are in right hand configuration. Part numbers shown above are for 23mm backset lock, if 25.4mm is required substitute 3 for 4 i.e. 4782, or if 30mm or 38mm lock is required, substitute 3 for 5 or 6 respectively i.e. 5782, 6782

*Anti-lockout - Closing the door or retracting latch bolt unlocks the lock, preventing lockout situations.

#Latch bolt can be held within the lock. Lock function recommended for use in holdback application.

Legend

Hub Setting



Anti-lockout Selection



Cam or Adaptor



Selector® 3782 Short Backset Escape Locks

Anti-lockout Escape Lock with Turn*

Part Number 3782-TA

Turnknob inside.

Outside: Opened by handle when unlocked.

Inside: Opened by handle at all times. Turnknob locks or unlocks outside handle.

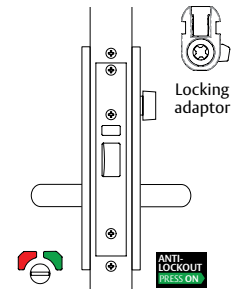

Anti-lockout Anti-vandal Escape Lock with Turn*

Part Number 3782VTA

Cylinder and turnknob.

Outside: Opened by handle when unlocked. Key locks or unlocks outside handle and retracts bolt after unlocking lock.

Inside: Opened by handle at all times. Turnknob locks or unlocks outside handle.

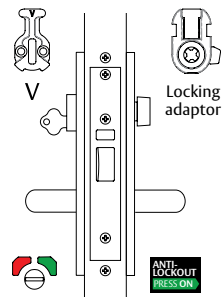

Notes:

All drawings shown are in right hand configuration. Part numbers shown above are for 23mm backset lock, if 25.4mm is required substitute 3 for 4 i.e. 4782, or if 30mm or 38mm lock is required, substitute 3 for 5 or 6 respectively i.e. 5782, 6782

*Anti-lockout - Closing the door or retracting latch bolt unlocks the lock, preventing lockout situations.

#Latch bolt can be held within the lock. Lock function recommended for use in holdback application.

Legend

Hub Setting



Anti-lockout Selection



Cam or Adaptor



Selector® 3784 Short Backset Combination Locks



Description

These locks have various latching functions operated generally by outside or inside handles, except when locked by key outside or by key or turnknob inside.

Product Details

| | |
|--------------------------|---|
| Furniture | Compatible with Lockwood 4800 and 5800 Series Furniture. Refer to lockweb.com.au for further details. |
| Latch | Deadlatch only. |
| Standard Finishes | Stainless Steel (SS) Other finishes available via finish kit conversions. |

Selector® 3784 Short Backset Combination Locks

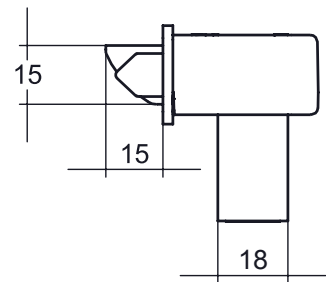
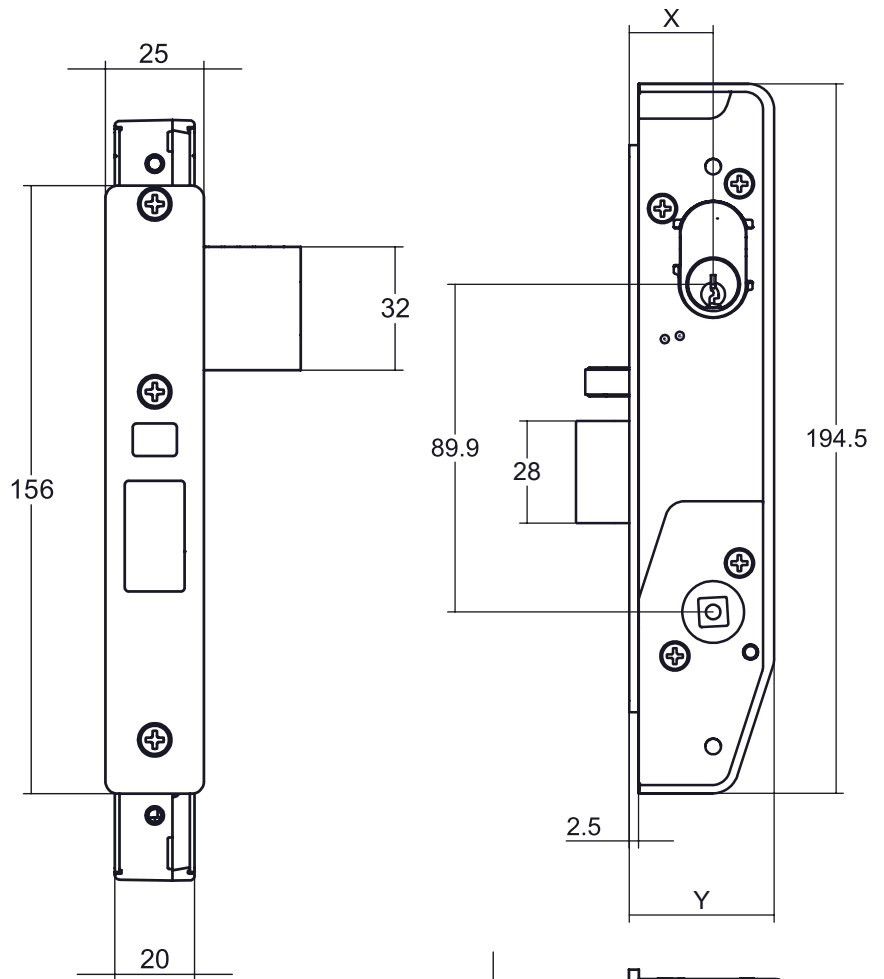

Selector® 3784 Short Backset Combination Locks

| Part Number | 3784 | 4784 | 5784 | 6784 |
|--------------------------------|------|------|------|------|
| Dimension X | 23 | 25.4 | 30 | 38 |
| Dimension Y | 40 | 42.4 | 47 | 55 |
| Minimum internal depth of door | 40 | 43 | 47 | 55 |

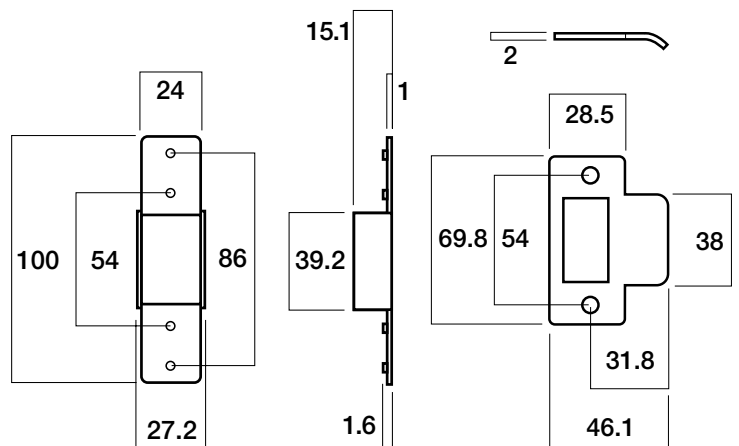

Selector® 3784 Short Backset Combination Locks

| Passage Latch | |
|---------------|------|
| Part Number | 3784 |

No locking function. Plainlatch only.
Outside: Opened by handle at all times.
Inside: Opened by handle at all times.

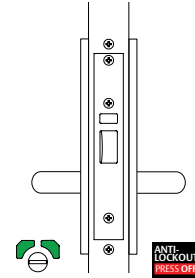

| Anti-vandal Lock with Turn# | |
|-----------------------------|--------|
| Part Number | 3784VT |

Cylinder and turnknob.
Outside: Opened by handle when unlocked. Key locks or unlocks both handles and retracts bolt after unlocking lock.
Inside: Opened by handle when unlocked. Turnknob locks or unlocks both handles.

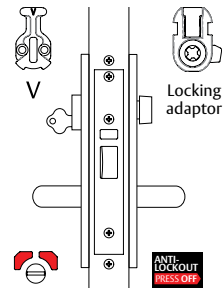

| Anti-vandal Lock with Internal Cylinder# | |
|--|--------|
| Part Number | 3784VV |

Double cylinder.
Outside: Opened by handle when unlocked. Key locks or unlocks both handles and retracts bolt after unlocking lock.
Inside: Opened by handle when unlocked. Key locks or unlocks both handles and retracts bolt after unlocking lock.

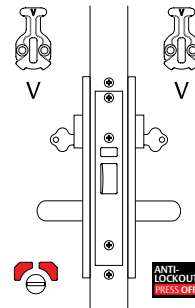

| Key Entry Lock with Internal Cylinder# | |
|--|--------|
| Part Number | 3784XV |

Double cylinder.
Outside: Opened by key at all times. Opened by handle when unlocked. Key locks both handles.
Inside: Opened by handle when unlocked. Key locks or unlocks both handles and retracts bolt after unlocking lock.

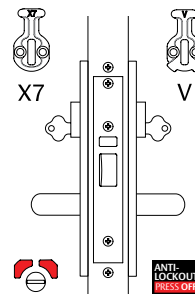

Notes:
 All drawings shown are in right hand configuration. Part numbers shown above are for 23mm backset lock, if 25.4mm is required substitute 3 for 4 i.e. 4784, or if 30mm or 38mm lock is required, substitute 3 for 5 or 6 respectively i.e. 5784, 6784
 *Anti-lockout - Closing the door or retracting latch bolt unlocks the lock, preventing lockout situations.
 #Latch bolt can be held within the lock. Lock function recommended for use in holdback application.

| Legend | |
|------------------------|--------|
| Hub Setting | |
| Anti-lockout Selection | |
| Cam or Adaptor | X7 |

Selector® 3784 Short Backset Combination Locks

Key Entry Double Cylinder Lock

Part Number 3784XX

Double cylinder.

Outside: Opened by key at all times. Handle always rigid.

Inside: Opened by key at all times. Handle always rigid.

This function requires the locking bar to be positioned in the locked position once lock is set.

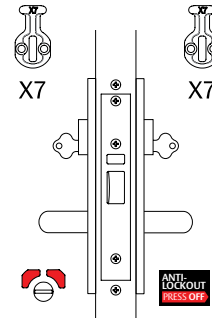

Combination Lock with Turn#

Part Number 3784-T

Turnknob inside.

Outside: Opened by handle when unlocked.

Inside: Opened by handle when unlocked. Turnknob locks or unlocks both handles.

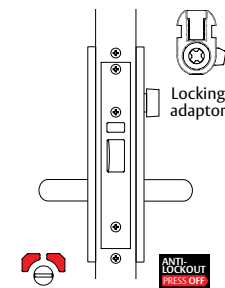

Anti-lockout Combination Lock with Turn*

Part Number 3784-TA

Turnknob inside.

Outside: Opened by handle when unlocked.

Inside: Opened by handle when unlocked. Turnknob locks or unlocks both handles.

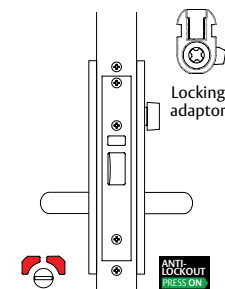

Anti-lockout Anti-vandal Lock with Turn*

Part Number 3784VTA

Cylinder and turnknob.

Outside: Opened by handle when unlocked. Key locks or unlocks both handles and retracts bolt after unlocking lock.

Inside: Opened by handle when unlocked. Turnknob locks or unlocks both handles.

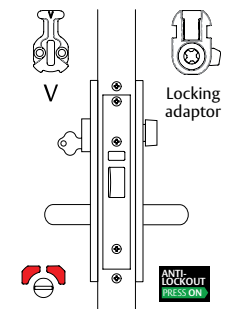

Notes:

All drawings shown are in right hand configuration. Part numbers shown above are for 23mm backset lock, if 25.4mm is required substitute 3 for 4 i.e. 4784, or if 30mm or 38mm lock is required, substitute 3 for 5 or 6 respectively i.e. 5784, 6784

*Anti-lockout - Closing the door or retracting latch bolt unlocks the lock, preventing lockout situations.

#Latch bolt can be held within the lock. Lock function recommended for use in holdback application.

Legend

Hub Setting



Anti-lockout Selection



Cam or Adaptor



Selector® 3784 Short Backset Combination Locks

Anti-lockout Anti-vandal Lock with Internal Cylinder*

Part Number 3784VVA

Double cylinder.

Outside: Opened by handle when unlocked. Key locks or unlocks both handles and retracts bolt after unlocking lock.

Inside: Opened by handle when unlocked. Key locks or unlocks both handles and retracts bolt after unlocking lock.

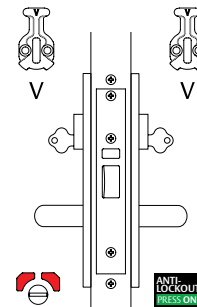

Notes:

All drawings shown are in right hand configuration. Part numbers shown above are for 23mm backset lock, if 25.4mm is required substitute 3 for 4 i.e. 4784, or if 30mm or 38mm lock is required, substitute 3 for 5 or 6 respectively i.e. 5784, 6784

*Anti-lockout - Closing the door or retracting latch bolt unlocks the lock, preventing lockout situations.

#Latch bolt can be held within the lock. Lock function recommended for use in holdback application.

| Legend | |
|------------------------|--|
| Hub Setting | |
| Anti-lockout Selection | |
| Cam or Adaptor | |

Selector® 3787 Short Backset Dual Entry Locks



Description

Designed to enable third parties such as emergency services to enter specific areas by second cylinder without giving access to all locksets in the building and the ability to lockout keys with restricted access at certain times.

Product Details

| | |
|--------------------------|---|
| Furniture | Compatible with Lockwood 4800 and 5800 Series Furniture. Refer to lockweb.com.au for further details. |
| Latch | Deadlatch only. |
| Standard Finishes | Stainless Steel (SS) Other finishes available via finish kit conversions. |

Selector® 3787 Short Backset Dual Entry Locks

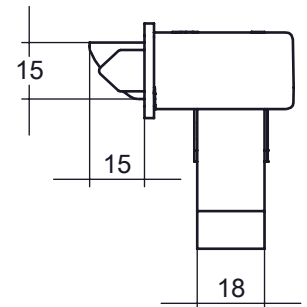
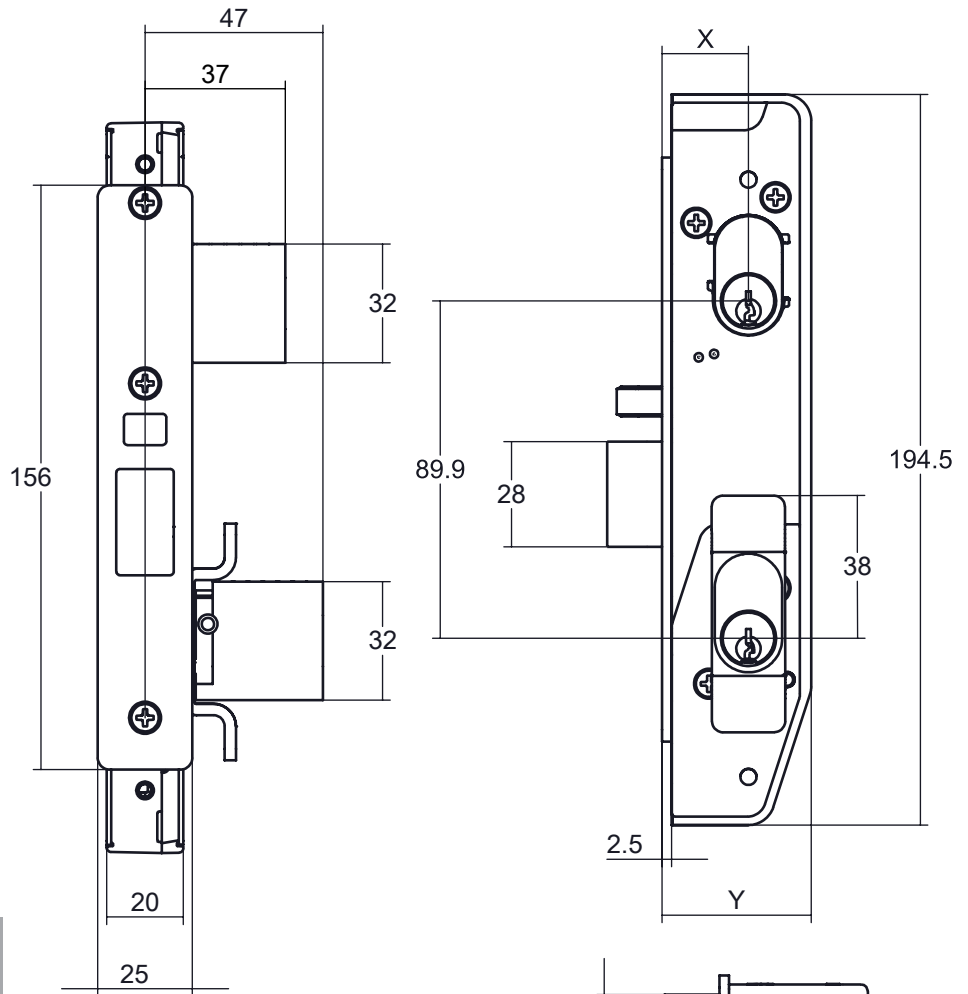

Selector® 3787 Short Backset Dual Entry Locks

| Part Number | 3787 | 4787 | 5787 | 6787 |
|--------------------------------|------|------|------|------|
| Dimension X | 23 | 25.4 | 30 | 38 |
| Dimension Y | 40 | 42.4 | 47 | 55 |
| Minimum internal depth of door | 40 | 43 | 47 | 55 |

*Order by specifying 3782SS primary lock and 3787-KIT570E Dual Entry Kit. Cylinders must be ordered separately. Dual Entry Kit only suits 43 - 46mm door thickness.

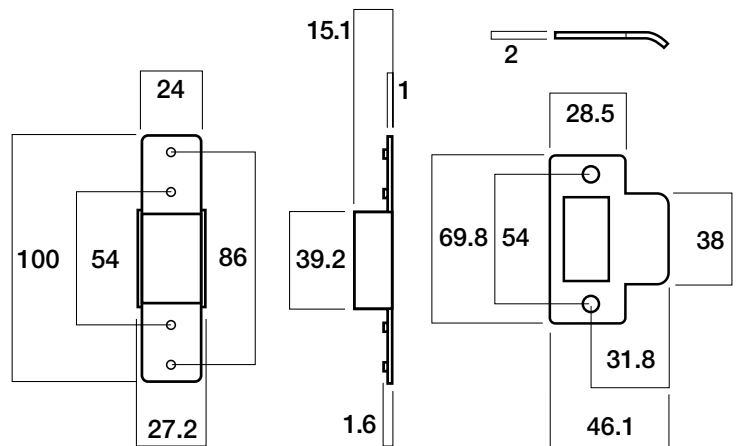

Selector® 3787 Short Backset Dual Entry Locks

Dual Entry Lock

Part Number 3787X-

Two cylinders outside.

Outside: Opened by key. Cylinders are keyed to differ.

Inside: Opened by handle at all times.

This function requires the locking bar to be positioned in the locked position once lock is set.

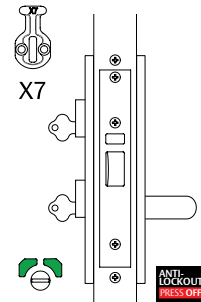

Dual Entry Lock with Lower Cylinder Lockout

Part Number 3787V-

Two cylinders outside.

Outside: Opened by key when unlocked. Upper cylinder key locks or unlocks lower cylinder and retracts bolt after unlocking lock. Cylinders are keyed to differ.

Inside: Opened by handle at all times.

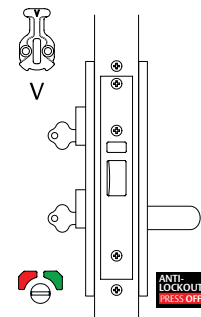

Notes:

All drawings shown are in right hand configuration. Part numbers shown above are for 23mm backset lock, if 25.4mm is required substitute 3 for 4 i.e. 4787, or if 30mm or 38mm lock is required, substitute 3 for 5 or 6 respectively i.e. 5787, 6787

Legend

Hub Setting



Anti-lockout Selection



Cam or Adaptor



Selector® 3782 Short Backset DX Digital Mortice Locks



Description

Lockwood DX Digital Locksets provide a mechanical method of keyless entry.

For extra security when under forced attack, the inbuilt clutching mechanism allows the outside turnknob to rotate without operating or damaging the lock.

The factory set 4 digit code is easily changed to any 4, 5 or 6 digit code using the code changing kit provided with each lock.

Lockwood Digital DX Locksets are designed to control access in commercial areas.

As the digital lockset utilizes mechanical operation, electrical wiring is not required.

Product Details

| | |
|-------------------------|--|
| Door Thickness | 32 to 50mm for timber doors. 35 to 50mm for metal doors |
| Finish | Codepad: Satin Chrome Brushed (SC) Mortice Lock: Stainless Steel (SS) |
| Codepad Assembly | High purity zinc alloy, 45mm wide, 164mm high, 52mm projection |
| Latch | Stainless steel with 15mm projection |

Note: As suitability of lever will be influenced by the lock backset, refer to chart for Lever/Backset compatibility Lockwood Door Handle Catalogue. Lockwood 4800 and 5800 Series (ordered separately).

Backset

Open-out door: 23, 25.4, 30 and 38mm.
Open-in door: 38mm recommended.
Installation of 23, 25.4 or 30mm on open-in doors would require the door stop to be machined to clear the digital pad.

Inside Function

Opened by lever handle at all times.

Holdback Function

Holdback function is available, this requires the inclusion of an internal cylinder.

Selector® 3782 Short Backset DX Digital Mortise Locks



Exterior



Interior

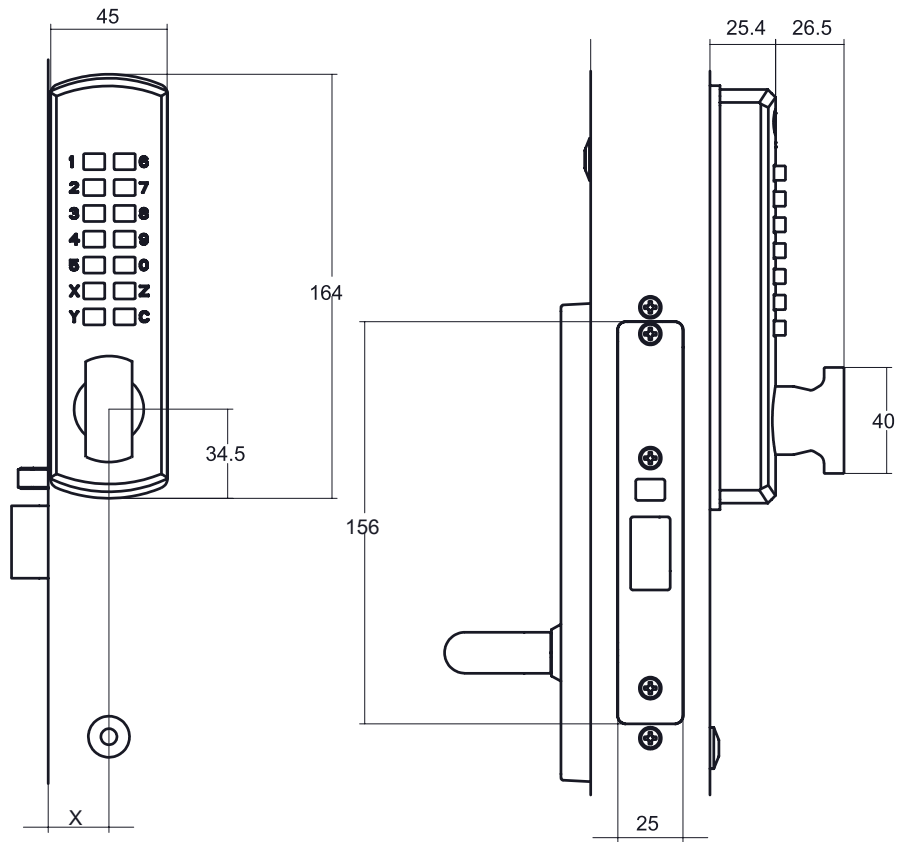

Selector® 3782 Short Backset DX Digital Mortise Locks

| Part Number | 3782DX | 4782DX | 5782DX | 6782DX |
|-------------|--------|--------|--------|--------|
| Dimension X | 23 | 25.4 | 30 | 38 |

Note: Order by specifying 3782SS primary lock and 3782-DXKITSC.

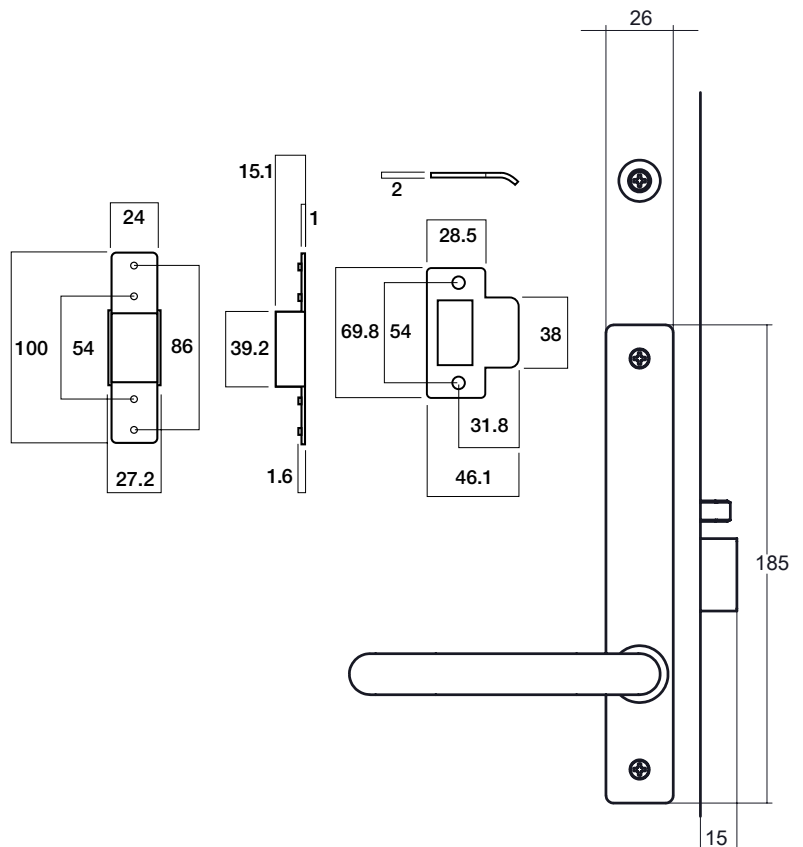

Selector® 3782 Short Backset DX Digital Mortice Locks

DX Digital Mortice Lock

Part Number 3782DX-

DX Digital outside, plate furniture inside.

Outside: Opened by DX Digital with code.

Inside: Opened by handle at all times.

This function requires the locking bar to be positioned in the locked position once lock is set.

DX Digital Mortice Lock with Holdback by Cylinder#

Part Number 3782DXV

DX Digital outside, plate furniture and cylinder inside.

Outside: Opened by DX Digital with code.

Inside: Opened by handle at all times. Holdback activated by key. Key retracts latch after releasing holdback.

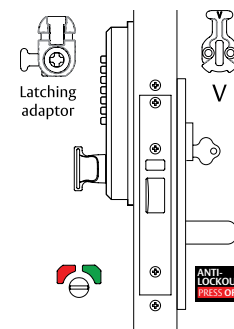
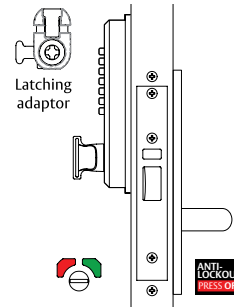

Notes:

All drawings shown are in right hand configuration. Part numbers shown above are for 23mm backset lock, if 25.4mm is required substitute 3 for 4 i.e. 4782, or if 30mm or 38mm lock is required, substitute 3 for 5 or 6 respectively i.e. 5782, 6782

#Latch bolt can be held within the lock. Lock function recommended for use in holdback application.

Legend

Hub Setting



Anti-lockout Selection



Cam or Adaptor



Selector® 3782 Short Backset Key Override DX Digital Mortice Locks



Description

Lockwood DX Digital Locksets provide a mechanical method of keyless entry.

For extra security when under forced attack, the inbuilt clutching mechanism allows the outside turnknob to rotate without operating or damaging the lock.

The factory set 4 digit code is easily changed to any 4, 5 or 6 digit code using the code changing kit provided with each lock.

Lockwood Digital DX Locksets are designed to control access into commercial areas.

As the digital lockset utilizes mechanical operation, electrical wiring is not required.

Product Details

| | |
|-------------------------|--|
| Door Thickness | 43 to 46mm for metal doors |
| Finish | Codepad: Satin Chrome Brushed (SC) Mortice Lock: Stainless Steel (SS) |
| Codepad Assembly | High purity zinc alloy, 45mm wide, 164mm high, 52mm projection |
| Latch | Stainless steel with 15mm projection |

Note: As suitability of lever will be influenced by the lock backset, refer to chart for Lever/Backset compatibility Lockwood Door Handle Catalogue. Lockwood 4800 and 5800 Series (ordered separately).

Backset

Open-out door: 23, 25.4, 30 and 38mm.
Open-in door: 38mm recommended.
Installation of 23, 25.4 or 30mm on open-in doors would require the door stop to be machined to clear the digital pad.

Inside Function

Opened by lever handle at all times.

Holdback Function

Holdback function is available, this requires the inclusion of an internal cylinder.

Selector® 3782 Short Backset Key Override DX Digital Mortise Locks



Exterior

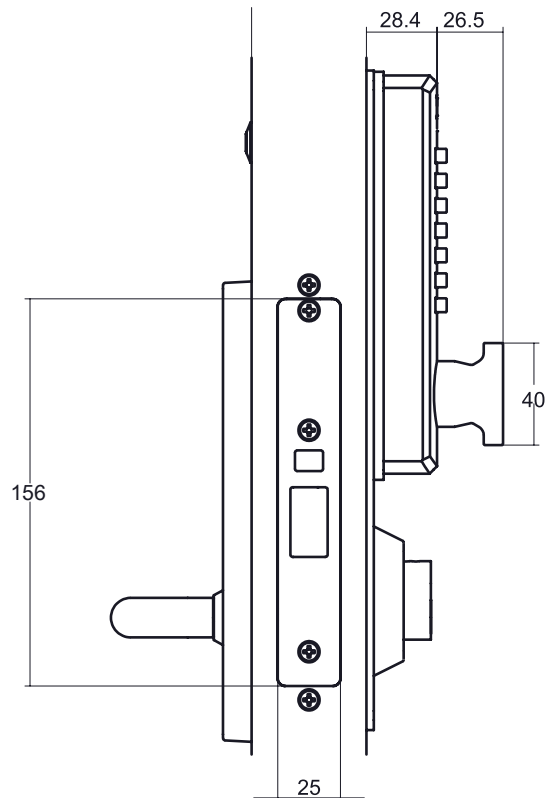
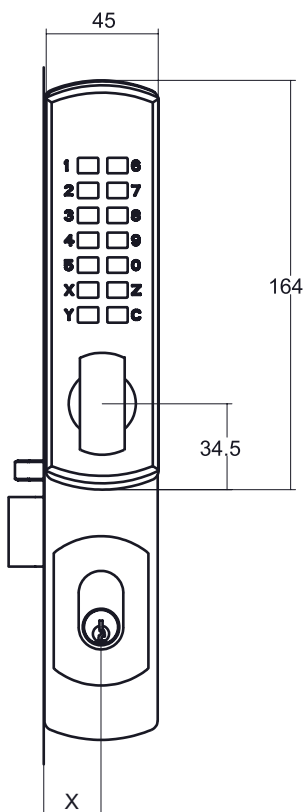

Interior

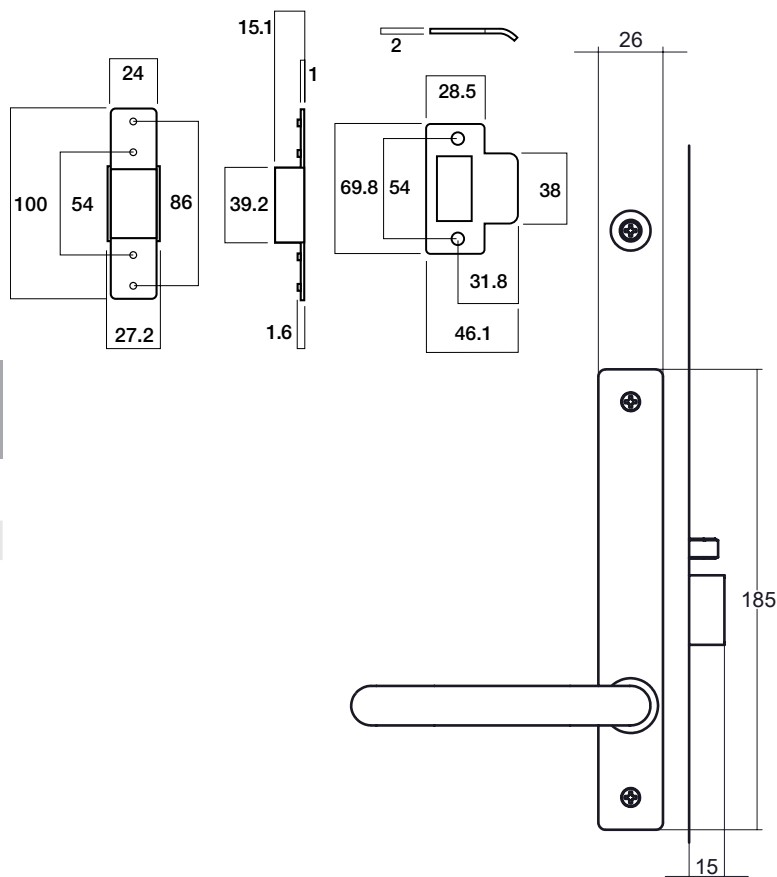

Selector® 3782 Short Backset Key Override DX Digital Mortise Locks

| Part Number | 3782DXKO | 4782DXKO | 5782DXKO | 6782DXKO |
|-------------|----------|----------|----------|----------|
| Dimension X | 23 | 25.4 | 30 | 38 |

Note: Order by specifying 3782SS primary lock and 3782-DXKOKITSC. Cylinders must be ordered separately. Key Override DX Digital kit only suits 43-46mm door thickness.

Selector® 3782 Short Backset Key Override DX Digital Mortice Locks

DX Digital Mortice Lock with Key Override

Part Number 3782DXKO-

DX Digital and lower cylinder outside, plate furniture inside.

Outside: Opened by DX Digital with code or key at all times.

Inside: Opened by handle at all times.

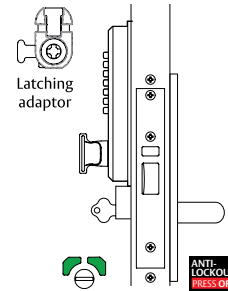

DX Digital Mortice Lock with Key Override and Internal Cylinder#

Part Number 3782DXKOV

DX Digital and lower cylinder outside, plate furniture
and cylinder inside.

Outside: Opened by DX Digital with code or key at all times.

Inside: Opened by handle at all times. Holdback activated by key.
Key retracts latch after releasing holdback.

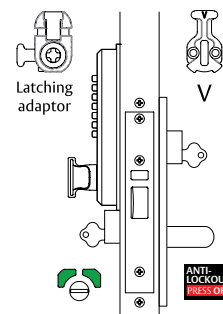

Notes:

All drawings shown are in right hand configuration. Part numbers shown above are for 23mm backset lock, if 25.4mm is required substitute 3 for 4 i.e. 4787, or if 30mm or 38mm lock is required, substitute 3 for 5 or 6 respectively i.e. 5787, 6787

#Latch bolt can be held within the lock. Lock function recommended for use in holdback application.

Legend

Hub Setting



Anti-lockout Selection



Cam or Adaptor



Selector® 3780 Series Accessories

Dual Entry Kit

| Part Number | Application |
|--------------|--------------------------------------|
| 3787-KIT570E | For new 3787 dual entry applications |

Dual Entry Kit include: Lower cylinder mounting plate, spindle cam and mounting screws.

Cylinders must be ordered separately. Dual Entry Kit only suitable on doors 43-46mm thick.

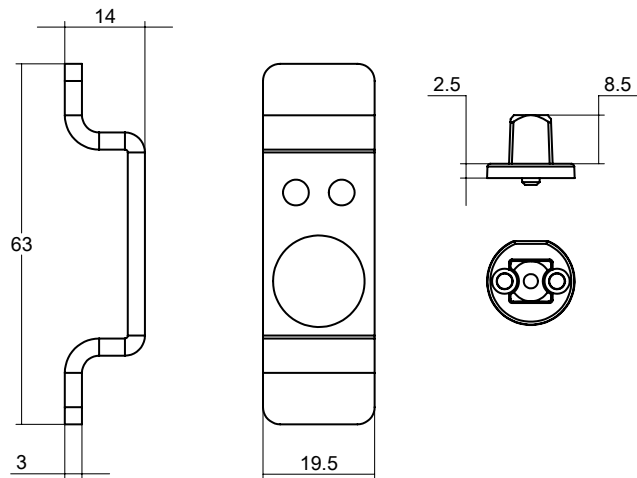

DX Digital Kits

| Part Number | Application |
|----------------|----------------------------------|
| 3782-DXKITSC | DX Digital Kit |
| 3782-DXKOKITSC | DX Digital with Key Override Kit |

DX Digital kits include: Digital codepad, mounting plate, codepad spindle, associated mounting screws and a latching adaptor.

Cylinders and door furniture (4800 or 5800 series) must be ordered separately.

DX Digital with Key Override only suitable on doors 43-46mm thick.

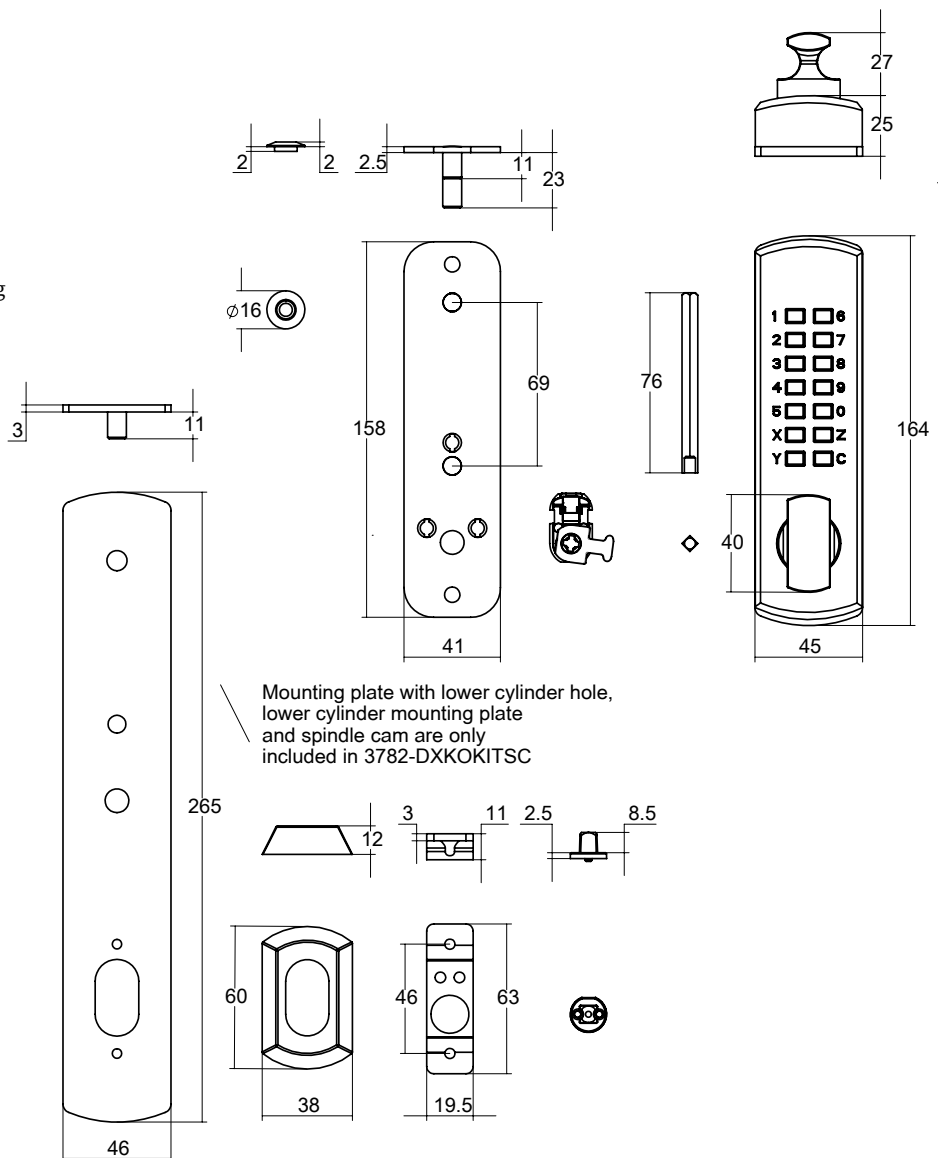

Selector® 3780 Series Accessories

Alternative Finish Kits

| Part Number | Finish |
|----------------|--------------|
| 3782-FINKITCP* | Chrome Plate |
| 3782-FINKITPC | Powder Coat |

Finish kits include: Strike, faceplate and screws.
 Finish kits are not suitable for use with 25.4mm backset 4782 lock.

*Screws not included.

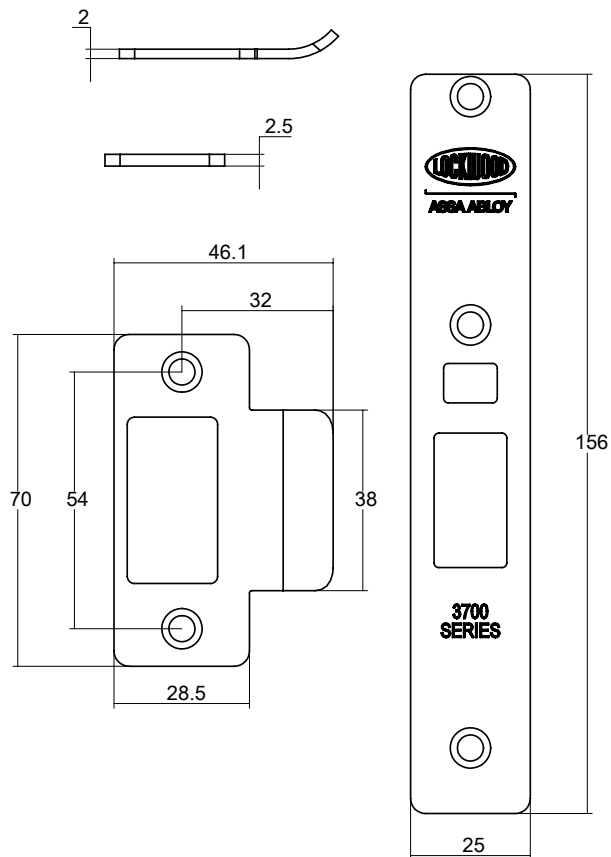

Timber Door Fixing Kit

| Part Number | Finish |
|---------------|-----------------|
| 3782-TFKITSS* | Stainless Steel |
| 3782-TFKITCP* | Chrome Plate |
| 3782-TFKITPB | Polished Brass |

Timber door fixing kits are not suitable for use with 25.4mm backset 4782 lock.

*Faceplate screws not included

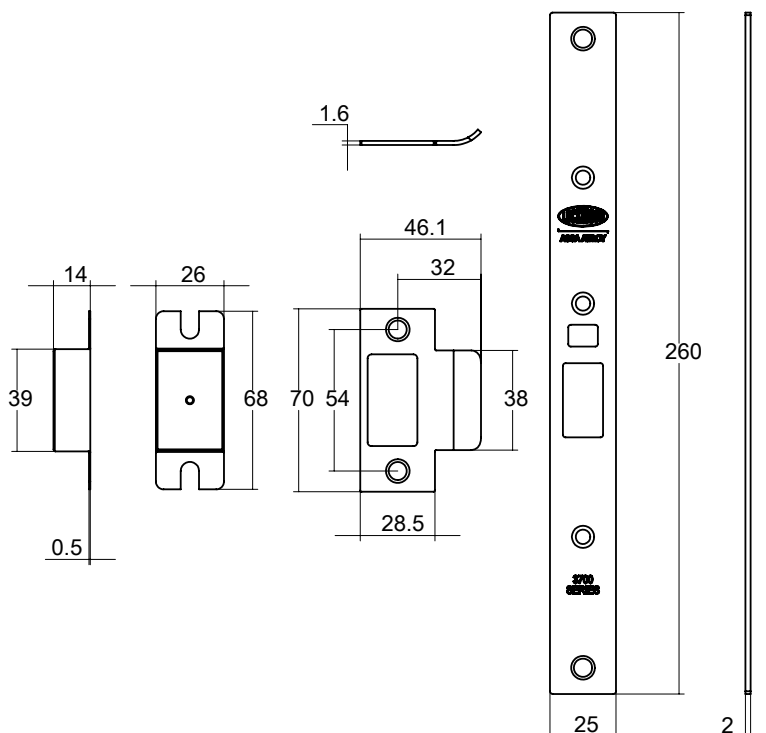

Selector® 3780 Series Accessories

ES2100 Electric Strike Faceplates

| Part Number | Application |
|----------------|---|
| 3782-2100SS | To suit 3780 Series |
| 3782TF-2100SS* | To suit 3780 Series with Timber Door Fixing |

To work in conjunction with the Lockwood Padde Series ES2100 electric strike for door position monitoring.

* Can be used directly with a 3782SS primary lock
- No additional TF fixing kit is required.

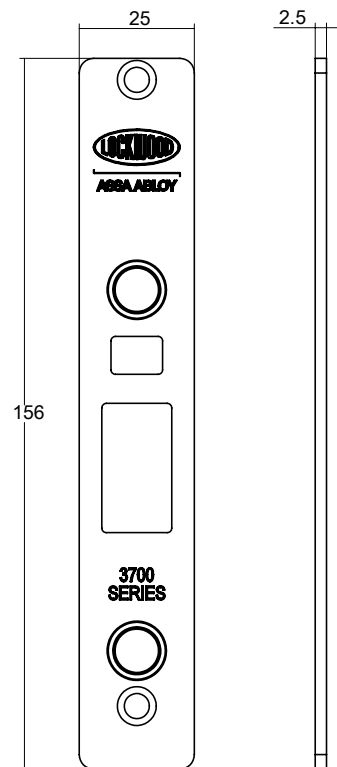

Security Faceplate Screw Kit

| Part Number | Application |
|-------------|---------------------|
| 3782-SECKIT | To suit 3780 Series |

Kit contains five replacement faceplate screws with tamper resistant TR20 Torx drive heads.

Selector® 3780 Series Accessories

Short/Extended Lipped Strikes

| Part Number | Lip Length A | Strike Length B |
|---------------|--------------|-----------------|
| 3782-STK32XX | 32mm | 46.1mm |
| 3782-STK74XX* | 74mm | 88.5mm |

To order, add finish code to part number.
XX designates the finish.

SS - Stainless Steel, **CP** - Chrome Plate, **PB** - Polished Brass

*Only available in Stainless Steel (**SS**) finish.

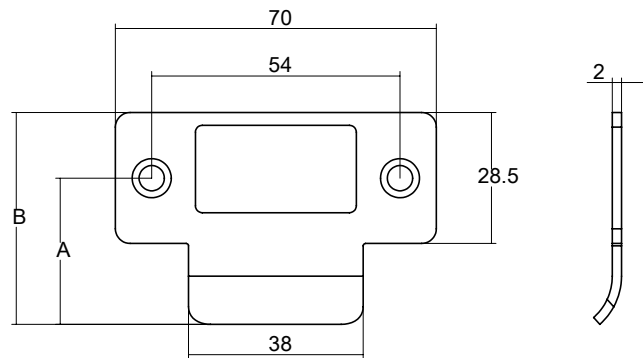

Fabricator Strikes

| Part Number | Lip Length A | Strike Length B |
|---------------|--------------|-----------------|
| 3782-FSTK32SS | 32mm | 47.2mm |
| 3782-FSTK64SS | 64mm | 80.2mm |

Stainless Steel D shaped strike.

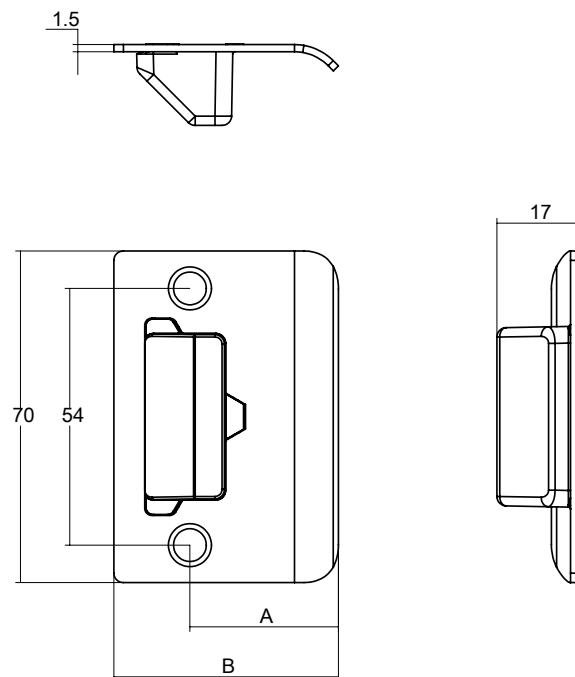

Selector® 3780 Series Accessories

Retrofit Strike Kits

| Part Number | Finish |
|--------------|----------------------|
| 3782-RFSTKCP | Chrome Plate |
| 3782-RFSTKSC | Satin Chrome Brushed |

For replacement of existing installations where Lockwood 5900, 595 and Astra Short Backset are used. For replacement of Astra specify 25.4mm backset.

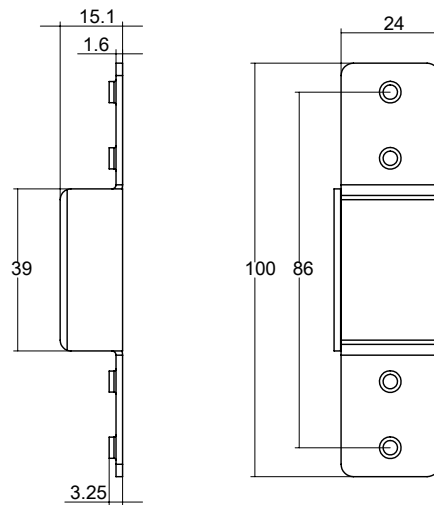
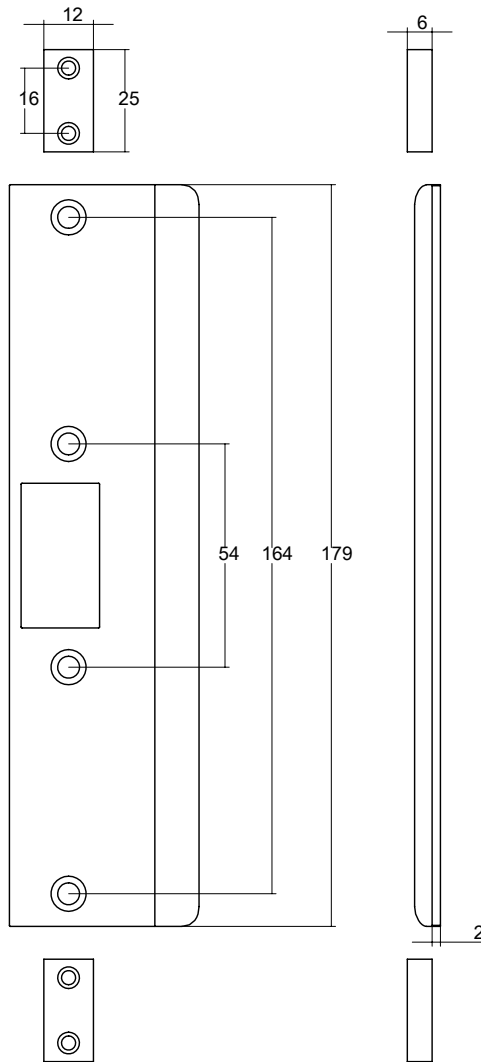

Selector® 3780 Series Accessories

Rebate Kits

| Part Number | Finish |
|--------------|-----------------|
| 5782-RK ##CP | Chrome Plate |
| 5782-RK ##SS | Stainless Steel |
| 5782-RK ##PB | Polished Brass |

Rebate kits to suit 13mm rebated timber doors with minimum backset of 30mm.

To order, add door handing to part number.

Refer to door handing guide at the bottom of page.

designates door handing.

CW - Clockwise

ACW - Anti-clockwise

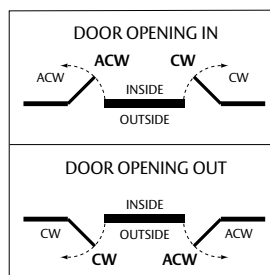
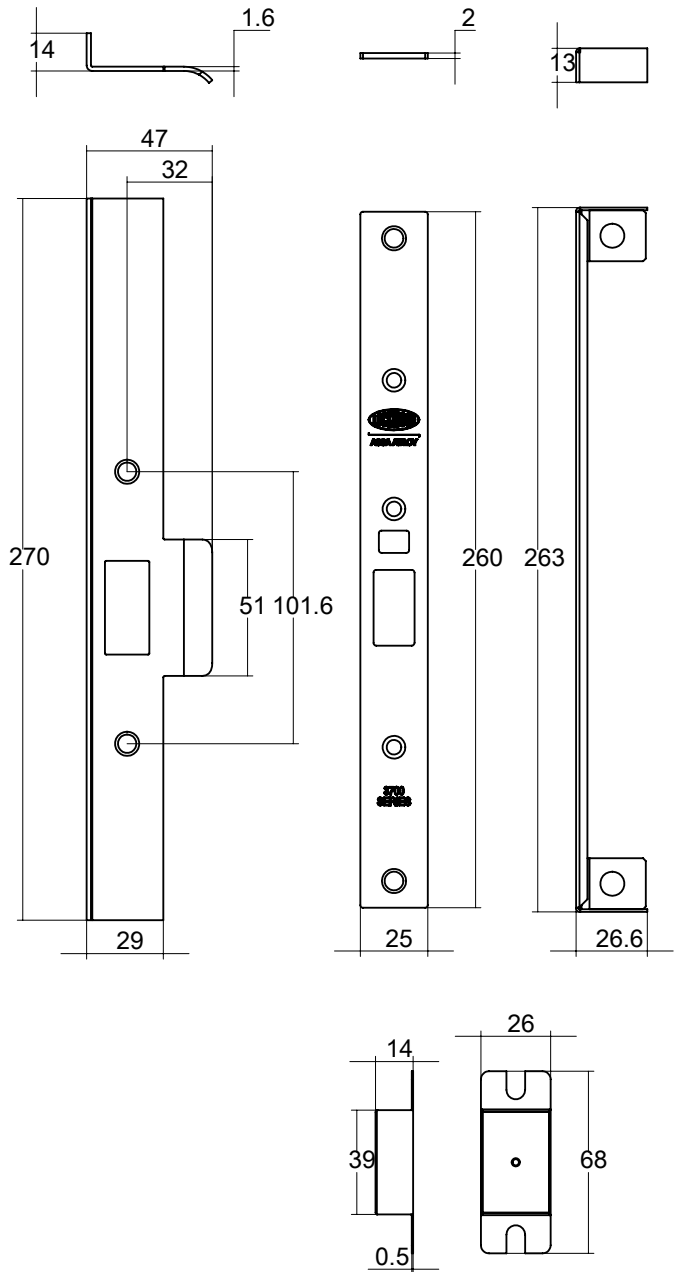

CW Left Hand open in
(Clockwise) Right Hand open out

ACW Left Hand open out
(Anti-Clockwise) Right Hand open in

Selector® 3780 Series Accessories

Mortice Lock Spindles

| Part Number | Pack Size | Length "A" | Door Thickness | |
|-------------|-----------|------------|----------------|-----|
| | | | Min | Max |
| SP3570-5018 | 10 | 33mm | 32 | 50 |
| SP3570-5228 | 1 | 45mm | 50 | 75 |
| SP3570-5238 | 1 | 58mm | 75 | 100 |
| SP3570-5258 | 1 | 108mm | 100 | 200 |

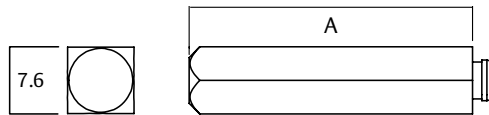

Single Cylinder Assemblies

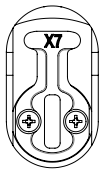

"X7" Cam Cylinder
570C4/X7

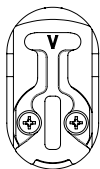

"V" Cam Cylinder
570C4/V



3787 Lower Cylinder
with Spindle Cam
570EC4/87

Cylinder Cams

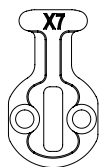

"X7" Cam
SP3700/X7CAM

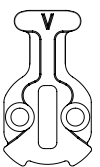

"V" Cam
SP3700/VCAM

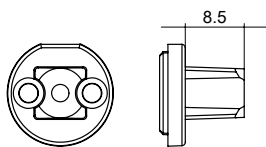

3787 Spindle Cam
SP3787/CAM

Adaptors

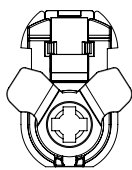

Locking Adaptor
3772-ADAPTOR

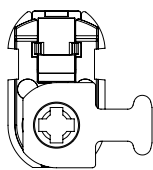

Latching Adaptor
3770-ADAPTOR

Selector® 3780 Series Cam and Adaptors Function Chart

Selector® 3780 Series Cam and Adaptors Function Chart

| Selector® 3780 Series | Function Description | Primary Lock | Outside Cylinder Cam/Adaptor | Inside Cylinder Cam/Adaptor | Kit |
|---|--|--------------|------------------------------|-----------------------------|--------------|
| Selector® 3780 Nightlatches | | | | | |
| 3780-TSS | Nightlatch with Turn | 3780TSS | - | 3770-ADAPTOR | |
| 3780X-SS | Nightlatch with Cylinder | 3782SS | X7 | - | |
| 3780XTSS | Nightlatch with Cylinder and Turn | 3780TSS | X7 | 3770-ADAPTOR | |
| 3780XXSS | Nightlatch with Double Cylinder | 3782SS | X7 | X7 | |
| Selector® 3782 Escape Locks | | | | | |
| 3782SS | Escape Primary Lock | 3782SS | - | - | |
| 3782-SS | Escape Lock | 3782SS | - | - | |
| 3782V-SS# | Anti-vandal Escape Lock | 3782SS | V | - | |
| 3782VTSS# | Anti-vandal Escape Lock with Turn | 3782TSS | V | 3772-ADAPTOR | |
| 3782X-SS | Key Entry Escape Lock | 3782SS | X7 | - | |
| 3782XTSS# | Key Entry Escape Lock with Turn | 3782TSS | X7 | 3772-ADAPTOR | |
| 3782-VSS# | Escape Lock with Internal Cylinder | 3782SS | - | V | |
| 3782-TSS# | Escape Lock with Turn | 3782TSS | - | 3772-ADAPTOR | |
| 3782XVSS# | Key Entry Escape Lock with Internal Cylinder | 3782SS | X7 | V | |
| 3782-TASS | Anti-lockout Escape Lock with Turn | 3782TSS | - | 3772-ADAPTOR | |
| 3782VTASS | Anti-lockout Anti-vandal Escape Lock with Turn | 3782TSS | V | 3772-ADAPTOR | |
| Selector® 3784 Combination Locks | | | | | |
| 3784SS | Passage Latch | 3782SS | - | - | |
| 3784VTSS# | Anti-vandal Lock with Turn | 3782TSS | V | 3772-ADAPTOR | |
| 3784VVSS# | Anti-vandal Lock with Internal Cylinder | 3782SS | V | V | |
| 3784XVSS# | Key Entry Lock with Internal Cylinder | 3782SS | X7 | V | |
| 3784XXSS | Key Entry Double Cylinder Lock | 3782SS | X7 | X7 | |
| 3784-TSS | Combination Lock with Turn | 3782TSS | - | 3772-ADAPTOR | |
| 3784-TASS | Anti-lockout Combination Lock with Turn | 3782TSS | - | 3772-ADAPTOR | |
| 3784VTASS | Anti-lockout Anti-vandal Lock with Turn | 3782TSS | V | 3772-ADAPTOR | |
| 3784VVASS | Anti-lockout Anti-vandal Lock with Internal Cylinder | 3782SS | V | V | |
| Selector® 3787 Dual Entry Locks | | | | | |
| 3787X-SS | Dual Entry Lock | 3782SS | X7, 3787 SPINDLE CAM | - | 3787-KIT570E |
| 3787V-SS | Dual Entry Lock with Lower Cylinder Lockout | 3782SS | V, 3787 SPINDLE CAM | - | 3787-KIT570E |

Selector® 3780 Series Cam and Adaptors Function Chart

Selector® 3780 Series Cam and Adaptors Function Chart

| Selector® 3780 Series | Function Description | Primary Lock | Outside Cylinder Cam/Adaptor | Inside Cylinder Cam/Adaptor | Kit |
|---|--|--------------|--------------------------------|-----------------------------|----------------|
| <i>Selector® Privacy Locks</i> | | | | | |
| 3782-TSS | Escape Privacy Lock | 3782TSS | - | 3772-ADAPTOR | |
| 3782-TASS | Anti-lockout Escape Privacy Lock | 3782TSS | - | 3772-ADAPTOR | |
| 3784-TSS | Privacy Lock | 3782TSS | - | 3772-ADAPTOR | |
| 3784-TASS | Anti-lockout Privacy Lock | 3782TSS | - | 3772-ADAPTOR | |
| 3787-TSS | Key Entry Privacy Lock | 3782TSS | 3787 SPINDLE CAM | 3772-ADAPTOR | 3787-KIT570E |
| 3787-TASS | Key Entry Anti-lockout Privacy Lock | 3782TSS | 3787 SPINDLE CAM | 3772-ADAPTOR | 3787-KIT570E |
| <i>Selector® 3782 DX Digital Locks</i> | | | | | |
| 3782DX-SS | DX Mechanical Digital Mortice Lock | 3782SS | 3770-ADAPTOR | - | 3782-DXKITSC |
| 3782DXVSS# | DX Mechanical Digital Mortice Lock with Internal Cylinder | 3782SS | 3770-ADAPTOR | V | 3782-DXKITSC |
| 3782DXKO-SS | DX Mechanical Digital Mortice Lock with Key Override | 3782SS | 3770-ADAPTOR, 3787 SPINDLE CAM | - | 3782-DXKOKITSC |
| 3782DXKOVSS# | DX Mechanical Digital Mortice Lock with Key Override and Internal Cylinder | 3782SS | 3770-ADAPTOR, 3787 SPINDLE CAM | V | 3782-DXKOKITSC |

Note: Items in Italics are Primary Locks and can be purchased from ASSA ABLOY.

#Lock function suitable for holdback application. Holdback can be activated at any time - unless anti-lockout is selected.

Cylinders sold separately, purchased configurations include adaptors as required.

Only 30mm and 38mm backset locks are suitable in DXs configurations on opening in doors.

Synergy Series Conversion Chart

Synergy Series Conversion Chart

| Synergy Series | Selector® 3780 Series | Function Description | Note |
|--------------------------|-----------------------|--|--|
| Escape Locks | | | |
| 3582SC | 3782SS | Escape Lock | |
| 3582-ASC | | | 3782 series primary lock has anti-lockout functionality. To set anti-lockout function, refer to setting and operating instructions. |
| 3582-T#SC | 3782-TSS | Escape Privacy Lock | |
| 3582WA#SC | 3782VTASS | Anti-lockout Anti-vandal Escape Lock with Turn | V cam has the functionality of locking lock just as the W cam. V cam also retracts bolt after unlocking lock. |
| 3582WT#SC | 3782VTSS | Anti-vandal Escape Lock with Turn | V cam has the functionality of locking lock just as the W cam. V cam also retracts bolt after unlocking lock. |
| 3582X-#SC | 3782X-SS | Key Entry Escape Lock | X7 cam has the functionality of retracting bolt and locking lock. Does not have unlocking functionality. |
| 3582XT#SC | 3782XTSS | Key Entry Escape Lock with Turn | X7 cam has the functionality of retracting bolt and locking lock. Does not have unlocking functionality. |
| 3582XZ#SC | 3782XVSS | Key Entry Escape Lock with Internal Cylinder | V cam has the functionality of locking lock just as the Z cam. V cam also retracts bolt after unlocking lock. X7 cam has the functionality of retracting bolt and locking lock. Does not have unlocking functionality. |
| 3582-Z#SC | 3782-VSS | Escape Lock with Internal Cylinder | V cam has the functionality of locking lock just as the Z cam. V cam also retracts bolt after unlocking lock. |
| 3582Z-#SC | 3782V-SS | Anti-vandal Escape Lock | V cam has the functionality of locking lock just as the Z cam. V cam also retracts bolt after unlocking lock. |
| Combination Locks | | | |
| 3584ET#SC | 3784-TSS | Combination Lock with Turn | |
| 3584#SC | 3784SS | Passage Latch | |
| 3584-T#SC | 3784-TSS | Combination Lock with Turn | |
| 3584WT#SC | 3784VTSS | Anti-vandal Lock with Turn | V cam has the functionality of locking lock just as the W cam. V cam also retracts bolt after unlocking lock. |
| 3584XX#SC | 3784XXSS | Key Entry Double Cylinder Lock | X7 cam has the functionality of retracting bolt and locking lock. Does not have unlocking functionality. |
| 3584XZ#SC | 3784XVSS | Key Entry Lock with Internal Cylinder | V cam has the functionality of locking lock just as the Z cam. V cam also retracts bolt after unlocking lock. X7 cam has the functionality of retracting bolt and locking lock. Does not have unlocking functionality. |
| 3584Z-#SC | 3784V-SS | Anti-vandal Lock | V cam has the functionality of locking lock just as the Z cam. V cam also retracts bolt after unlocking lock. |
| 3584ZZ#SC | 3784VSS | Anti-vandal Lock with Internal Cylinder | V cam has the functionality of locking lock just as the Z cam. V cam also retracts bolt after unlocking lock. |
| Timber Fixing | | | |
| 3592SC | | | For timber fixing, specify the lock with an additional line 3782-TFKITxx where xx designates the required finish. |

Synergy Series Conversion Chart

Synergy Series Conversion Chart

| Synergy Series | Selector® 3780 Series | Function Description | Note |
|---|-----------------------|-------------------------------------|------|
| Extended Lip Strikes | | | |
| SP3580-53SC | 3782-STK32SS | 3782 STANDARD STRIKE 32MM LIP PK=10 | |
| SP3580-53CP | 3782-STK32CP | 3782 STANDARD STRIKE 32MM LIP PK=10 | |
| SP3580-53PB | 3782-STK32PB | 3782 STANDARD STRIKE 32MM LIP PK=10 | |
| SP3580-A53SC | 3782-STK74SS | 3782 LONG LIP STRIKE 74MM LIP | |
| SP3580-52 | 3782-STKBOX | 3782 STRIKE BOX PK=10 | |
| Surface Mounted Fabricator Lip Strikes | | | |
| SP3P80-053SS | 3782-FSTK32SS | 3782 FABRICATOR STRIKE KIT 32MM LIP | |
| SP3P80-153SS | 3782-FSTK64SS | 3782 FABRICATOR STRIKE KIT 64MM LIP | |
| Retrofit Strikes | | | |
| 3580-1902SC | 3782-RFSTKSC | 3782 RETROFIT STRIKE KIT | |
| 3580-1902CP | 3782-RFSTKCP | 3782 RETROFIT STRIKE KIT | |
| 3580-1902PB | 3782-RFSTKPB | 3782 RETROFIT STRIKE KIT | |
| Rebate Kits | | | |
| 3580-2902ACWSC | 5782-RKACWSS | 5782/6782 REBATE KIT ANTICLOCKWISE | |
| 3580-2902ACWCP | 5782-RKACWCP | 5782/6782 REBATE KIT ANTICLOCKWISE | |
| 3580-2902ACWPB | 5782-RKACWPB | 5782/6782 REBATE KIT ANTICLOCKWISE | |
| 3580-2902CWSC | 5782-RKCWSS | 5782/6782 REBATE KIT CLOCKWISE | |
| 3580-2902CWCP | 5782-RKCWCP | 5782/6782 REBATE KIT CLOCKWISE | |
| 3580-2902CWPB | 5782-RKCWPB | 5782/6782 REBATE KIT CLOCKWISE | |

Selector® 3780 Series Short Backset Mortice Locks Functioning Matrix

Functioning Matrix

Sample part number 3782VTASS is made up of seven elements.
The description of this part number is an Anti-lockout Anti-vandal escape lock with cylinder and turn in satin stainless steel finish. Choose your product by selecting an option from each element.

| Backset | Series | Platform | Function | Sub Function | Anit-lockout Selection | Finish |
|---------|--------|----------|----------|--------------|------------------------|--------|
| 3 | 7 | 8 | 2 | VT | A | SS |

Backset

| | |
|--------|---|
| 23mm | 3 |
| 25.4mm | 4 |
| 30mm | 5 |
| 38mm | 6 |

Series

| | |
|--------------------------------|---|
| Selector® Series Mortice Locks | 7 |
|--------------------------------|---|

Platform

| | |
|---------------|---|
| Short Backset | 8 |
|---------------|---|

Functions

| | |
|------------------|---|
| Nightlatch | 0 |
| Escape Lock | 2 |
| Combination Lock | 4 |
| Dual Entry Lock | 7 |

Sub Function

| | |
|--|--------|
| e.g. Outside | Inside |
| V | T |
| Locking and Latching Cylinder with V Cam | V |
| Latching Cylinder with X7 Cam | X |
| Turnbutton Adaptor | T |
| No Sub Function | - |
| DX Digital | DX |
| DX Digital with Key Override | DXKO |

Anit-lockout Selection

| | |
|--------------|---|
| Neutral | |
| Anti-lockout | A |

Finish

| | |
|-----------------|----|
| Stainless Steel | SS |
|-----------------|----|

Code

- 1. Backset:** Nominate backset as required, for example 3 = 23mm backset.
- 2. Function:** Select function, for example 782 = Escape Lock
- 3. Sub Function:** Determine sub function requirements for both exterior and interior.
For example:
Exterior – Locking function required – specify V (cylinder).
Interior – Turnknob function required – specify T (turnbutton adaptor).
- 4. Anti-lockout Selection:** Determine if anti-lockout function is needed.
For example:
Anti-lockout - Specify A
- 5. Finish:** Select appropriate finish, e.g. SS
Other finishes available by specifying finish kits.

**We take the worry out of
protecting what's valuable to you.**
Lockwood: *no worries*[®]



ASSA ABLOY

Lockwood is the leading brand in the Australian locking industry. With an established reputation for high quality products, this iconic brand provides a wide range of locking solutions to residential housing, commercial, semi-commercial, building and industrial application markets. Lockwood is supported by an extensive distribution and after-sales support network. Our customers include retailers, architects, trade and industrial personnel, locksmiths and security dealers.

ASSA ABLOY is the global leader in door opening solutions, dedicated to satisfying end-user needs for security, safety and convenience.

ASSA ABLOY is represented in all major regions, in both mature and emerging markets, with leading positions in Australia, Europe and North America.

**25YEAR
MECHANICAL
WARRANTY**

The Lockwood 25 Year Mechanical Warranty

Our belief that we manufacture the finest premium products available in today's market place is backed by the Lockwood 25 Year Mechanical Warranty, ensuring that Lockwood continues to keep Australians safe by delivering security and peace of mind.

For warranty terms and conditions, please visit www.lockweb.com.au or call **1300WARRANTY**

ASSA ABLOY Australia Pty Ltd
235 Huntingdale Road
Oakleigh, Victoria, 3166
Australia

1300 LOCK UP (1300 562 587)
lockweb.com.au

ASSA ABLOY New Zealand Ltd
6 Armstrong Road
Albany, Auckland, 0632
New Zealand

info.nz@assaabloy.com
Telephone +64 9415 7111
assaabloy.co.nz

Disclaimer

Whilst every effort has been made to ensure that the information (including product images and drawings) contained in this brochure is accurate at the time of publication, ASSA ABLOY Australia Pty Limited ("ASSA ABLOY") recommends that you consult ASSA ABLOY or its agents prior to placing an order to ascertain current information on specific products, as ASSA ABLOY reserves the right to make changes without notice. ASSA ABLOY will not be liable for any injury, loss or damage whatsoever, arising from any errors or omissions in the information contained in the brochure or arising from the use or application of the information contained herein. © 2016 copyright by ASSA ABLOY All rights reserved

