



Floor Closers

Floor Closers

7750 Series Floor Closer

The Lockwood 7750 Series Floor Closer range has been specifically designed to meet most situations where pivoted single or double action doors up to 300kg require positive and consistent operation.

Innovative design enables flexibility over a wide range of applications.

Designed and manufactured to world class standards which ensure the highest possible quality, efficient and reliable performance.

Multi functional designs offer the specifier, stockist or the installer outstanding versatility and low inventory levels.

Features and Specifications

Power Adjustable

- All models are power adjustable sizes 3 to 6 which allows adjustment at installation to suit most site conditions. Closing force ranges from 24 Nm to 60 Nm

Suitable for Doors

- Up to 1400mm in width (refer to selection chart)
- Up to 2500mm in height, minimum door thickness 40mm

Door Weight

- Up to 300kg

Door Controls (175° opening in both directions)

- Two independent adjustment valves provide full hydraulic control
- Closing from approximately 175° to 15°
- Latching from approximately 15° to 0°

Hold-Open

- 90° and 105°

Non Hold-Open (Fire Rated)

- Comes with non-adjustable mechanical back check at approximately 70°



FIRE RATED

The Lockwood 7750 Series Floor Closer has successfully been fire tested on fire door assemblies in accordance with Australian Standard AS 1905.1 - 2005: Fire Resistant Doorsets.

Built In Pressure Relief Valve

- To protect against abuse



Adjustment within Cement Box

- Large range of adjustment to suit most site conditions (see limiting dimensions on page 4.58)

Body

- Cast iron

Cement Box

- Hot zinc plated steel

Interchangeable Spindle

- A large range of spindles are available from +5 to +30mm to meet door heights above thresholds or uneven floor conditions

Finishes

Satin Stainless Steel (standard) SSS

Polished Stainless Steel
(order cover plate separately) PSS

Polished Brass
(order cover plate separately) PB

Floor Closers

7750 Series Floor Closer

Power and Closing Speed

Turn 17 mm hex force adjuster clockwise to increase power. Turn anti-clockwise to decrease power. Starting from the minimum power, with 10 complete turns maximum power is reached.

Thermostatic valves 1 and 2 independently control the general closing speed from 175° to 15° and the final closing from 15° to 0° (constant, damping or latching). Starting from valve closed, maximum speed is reached with three full turns anti-clockwise.

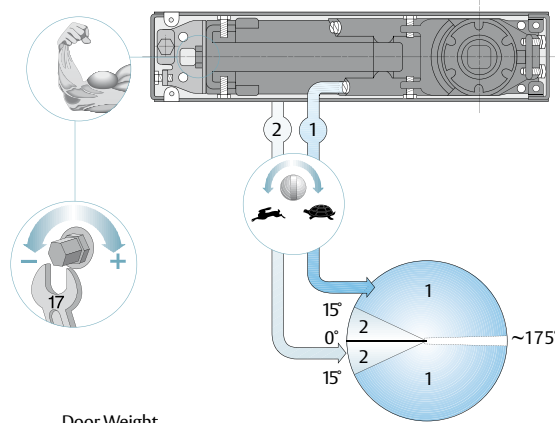

Recommended Door Size

Closing Force	Door Size	Door Weight
Min. power 3 = 24 Nm	min. 850 x 2300	300
Max. power 6 = 60 Nm	max. 1400 x 2500	300

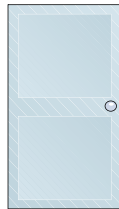

Part Numbers

*For a complete door kit order from **A - Hydraulic Units** + **B = Door Kits**.

A - Hydraulic Units		+ B - Door Kits	
Hydraulic Units	Door Kit	1. Door kit includes top pivot and bottom strap	7750-579
7755H90SSS = 90°	1 or 3	2. Fire rated door kit includes top pivot and bottom strap	7750-584
7750H105SSS = 105°	1 or 3	3. Non-handed offset arm kit for single acting doors	7750-305IL
7752NBCSSS = X	2 or 3		

Finishes

Satin Stainless Steel (standard)	SSS
Polished Stainless Steel (order cover plate separately)	PSS
Polished Brass (order cover plate separately)	PB

Extended Spindle Range

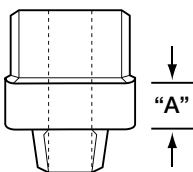

	Standard Inset	+5mm	+10mm	+15mm	+20mm	+25mm	+30mm
Part Number	SP7750-60	SP7750-60-5	SP7750-60-10	SP7750-60-15	SP7750-60-20	SP7750-60-25	SP7750-60-30

Floor Closers

7750 Series Floor Closer

Limiting Dimensions

Adjustments within Cement Box

Vertical	9 mm
Side	6 mm
Front	5 mm

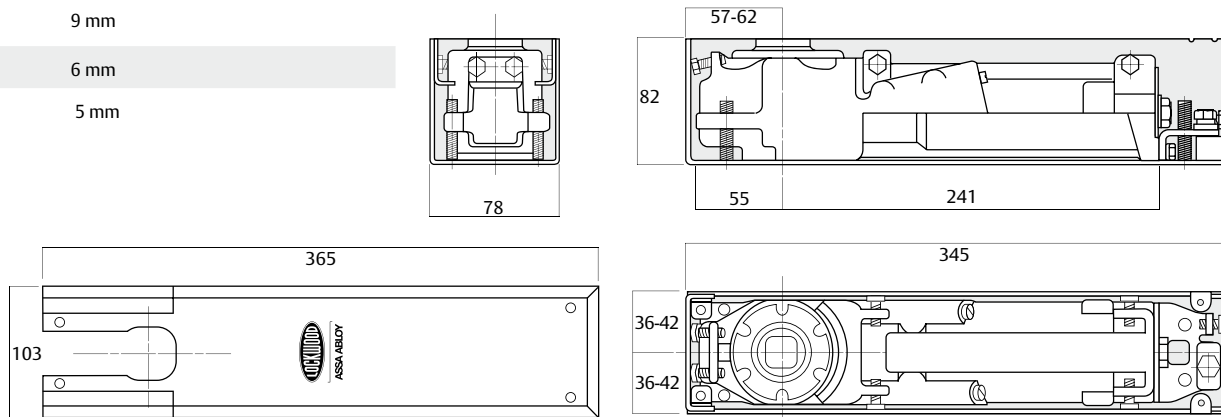

Universal Mounting

LEFT HAND

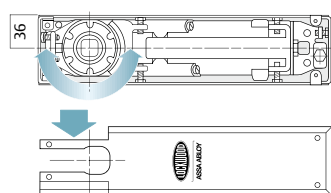

DOUBLE ACTION

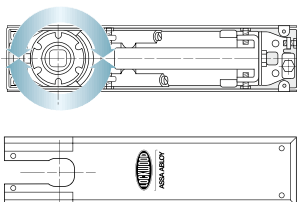

RIGHT HAND

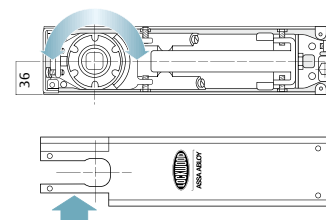

Spare Parts

SP7750-10

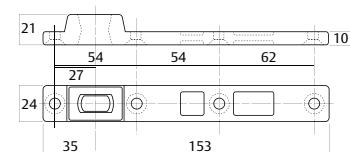

Reversible bottom arm in steel for double action doors.

FIRE RATED

SP7750-25

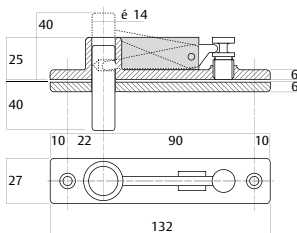

Double acting top pivot

7750-30SIL

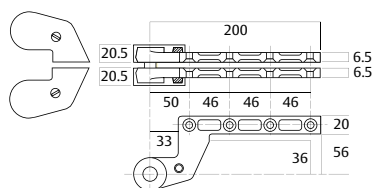

Top pivot in steel for left or right doors 36 mm offset. Maximum door weight 250kgs.

SP7750-20

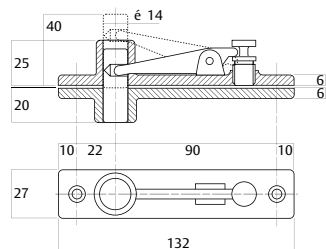

Double acting top pivot

FIRE RATED

SP7750-15

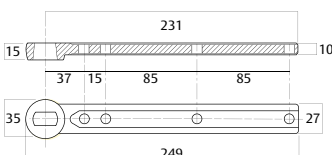

Bottom arm in steel for double action doors.

Floor Closers

8800 Series Floor Closer



ASSA ABLOY

The Lockwood 8800 Series Floor Closers are designed to provide door control on manually operated double action doors in a wide range of commercial applications. The mounting kit provided with the Lockwood 8800 Series will suit glass, timber and aluminium frame door construction as standard.

Features

- 2, 3 and 4 power
- Non hold-open
- 90° and 105° hold-open
- Adjustable pivot inserts
- Pivot door sets
- Lockwood guaranteed

Features and Specifications

Door Width

Up to 1150mm (refer to selection procedure)

Door Weight

Up to 120kg as standard

Door Thickness

Minimum for timber 32 mm

Door Control

Two independent adjustment valves provide full hydraulic control from 130° to 15° of closing and 15° to 0° of latching.

Door Frame Type

Timber/aluminium/steel

Non Hold-Open and Hold-Open Versions

Available in both non hold-open and hold-open versions. Mechanical hold-open 90° and 105° in separate units.

Door Adjustment

The Lockwood 8800 is positionally adjustable for a height of 4mm, a width of 10mm and a length of 9mm.

Finishes

Stainless Steel	SSS
Gold	GLD
Polished Stainless Steel	PSS

Other finishes on application.



Additional Features

Interchangeable extended pivot inserts ranging from +5 to +35mm. This range will accommodate applications such as threshold, carpeted floors or situations where additional clearance between the door and floor are required (see page 4.60).

Universal off set pivot sets for flush closing single action door applications (SP844-30).

Pivot Door Sets

Suitable for door applications where a free swing pivot door is required. Consists of retractable top pivot set with heavy duty bottom pivot and strap. Suitable for aluminium, glass and timber doors (see page 4.61).

Floor Closers

8800 Series Floor Closer

Limiting Dimensions

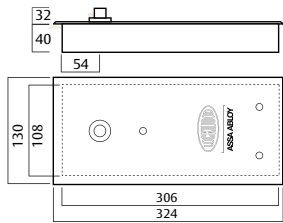

Bottom Strap

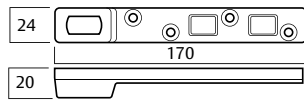

Top Pivot

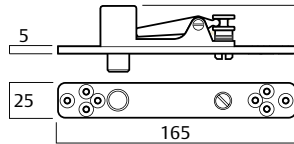

Top Pivot Housing

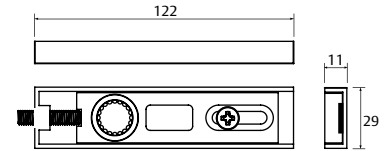

8800 Series Product Range

Non Hold-Open

8842NSSS	Size 2	Standard Floor Spring Non Hold-Open
8843NSSS	Size 3	Standard Floor Spring Non Hold-Open
8844NSSS	Size 4	Standard Floor Spring Non Hold-Open

105° Hold-Open

8842H105SSS	Size 2	Standard Floor Spring 105° Hold-Open
8843H105SSS	Size 3	Standard Floor Spring 105° Hold-Open
8844H105SSS	Size 4	Standard Floor Spring 105° Hold-Open

90° Hold-Open

8842H90SSS	Size 2	Standard Floor Spring 90° Hold-Open
8843H90SSS	Size 3	Standard Floor Spring 90° Hold-Open
8844H90SSS	Size 4	Standard Floor Spring 90° Hold-Open

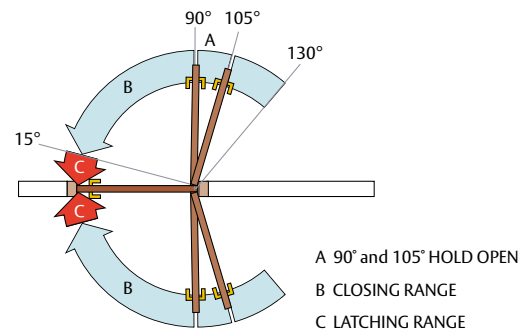

Size Selection Chart

Spring Size	Door Width	Max Door Weight	Closing Torque
2	850 mm	120 kg	20 Nm
3	950 mm	120 kg	27 Nm
4	1100 mm	120 kg	39 Nm

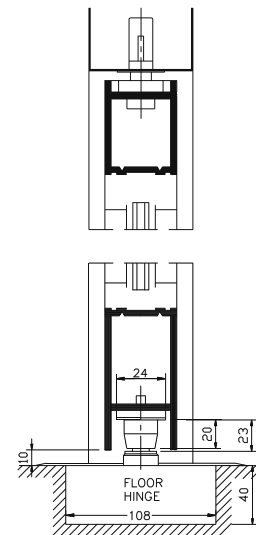

Extended Spindle Range

	Standard Inset	+5mm	+10mm	+15mm	+20mm	+25mm	+30mm
Part Number	SP884-60	SP884-60-5	SP884-60-10	SP884-60-15	SP884-60-20	SP884-60-25	SP884-60-30
3° Left Hand Offset							
Part Number	SP884-60LH	SP884-60-5LH	SP884-60-10LH	SP884-60-15LH	SP884-60-20LH	SP884-60-25LH	SP884-60-30LH
3° Right Hand Offset							
Part Number	SP884-60RH	SP884-60-5RH	SP884-60-10RH	SP884-60-15RH	SP884-60-20RH	SP884-60-25RH	SP884-60-30RH

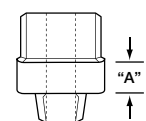

Floor Closers

8800 Series Floor Closer



ASSA ABLOY

Pivot Door Sets

Suitable for door applications where a free swing pivot door is required. Consists of retractable top pivot set with heavy duty bottom pivot and strap. Suitable for aluminium, timber and glass doors.

Pivot Door Set Product Range

Part Number	Description
985-300	Aluminium or Timber Door Pivot Kit
985-350	Glass Door Pivot Kit
985-400	Heavy Door Pivot Kit

Aluminium or Timber Door Pivot Kit

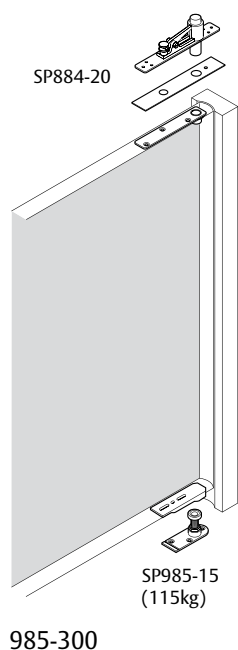

Glass Door Pivot Kit

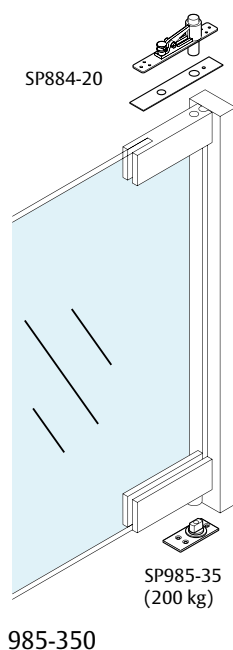

Heavy Door Pivot Kit

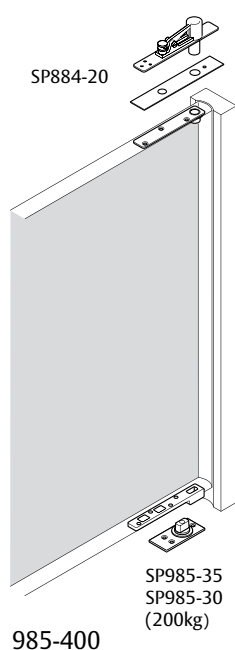

ASSA ABLOY is the global leader in door opening solutions, dedicated to satisfying end-user needs for security, safety and convenience



Lockwood is the leading brand in the Australian locking industry. With an established reputation for high quality products, this iconic brand provides a wide range of locking solutions to residential housing, commercial building and industrial application markets. Lockwood is supported by an extensive distribution and after-sales support network. Our customers include retailers, architects, trade and industrial personnel, locksmiths and security dealers.

ASSA ABLOY

ASSA ABLOY is the global leader in door opening solutions, dedicated to satisfying end-user needs for security, safety and convenience.

ASSA ABLOY is represented in all major regions, in both mature and emerging markets, with leading positions in Australia, Europe and North America.

As the world's leading lock group, ASSA ABLOY offers a more complete product range of door opening solutions than any other company in the market.

Australia
1300 LOCK UP (1300 562 587)
lockweb.com.au

New Zealand
+64 9415 7111
assaabloy.co.nz

ASSA ABLOY Australia Pty Ltd
235 Huntingdale Road
Oakleigh, Victoria, 3166
Australia

info.au@assaabloy.com
assaabloy.com.au

ASSA ABLOY New Zealand Ltd
6 Armstrong Road
Albany, North Shore City, 0632
New Zealand

info.nz@assaabloy.com
assaabloy.co.nz

