



VISION LEVERSETS & DOOR CLOSERS

— V 2 —



INTRODUCTION

Inspired by design, innovation and functionality, we are pleased to present our Vision Leversets & Door Closers catalogue.

Madinoz - as the name implies, is Made In OZ. It is our ability to work closely with architects, designers and developers which has allowed us to evolve with the market.

We are manufacturers of an ever expanding comprehensive range of architectural door hardware and use only quality materials such as solid brass and 316 marine-grade stainless steel to ensure lifelong usage.

Architects and designers may now be confident in selecting a quality well priced range with a distinctive design theme that will 'speak' throughout the whole project.

Madinoz combines handcrafted tradition with modern technology, to provide a well-priced product range which is refined to the smallest detail.

Please feel free to contact Madinoz should you have any special requirements or if you would like one of our Architectural Consultants to call on you.

We look forward to helping you and thank you for your interest and support.

Madinoz

Unit 3 / 1-7 Ada Avenue, Brookvale NSW 2100 Australia

Telephone: **(02) 9939 2007**

Facsimile: (02) 9939 8432

E-mail: sales@madinoz.com.au

Website: www.madinoz.com.au

GENERAL INFORMATION

Finishes:

- SC - Satin Chrome
- PC - Polished Chrome
- BK - Satin Black

Guarantee:

Madinoz Pty Ltd unconditionally guarantee their products against defects in workmanship and materials, subject to fair wear and tear within the normal working life of the product. Madinoz Pty Ltd assumes no liability for:

1. Improper installation or failure to follow fitting instructions.
2. Failure to improve maintenance.
3. Indirect or inconsequential loss or damage.
4. Cost of removal and/or replacement.
5. Cost of freight and/or travelling.

Design Registration:

Some of the products depicted in this catalogue are the subject of design registration.

Cleaning:

Madinoz products should be cleaned at regular intervals with a soft 'grit-free' cloth, clean soapy water and wiped dry.

Warning:

Do not use a scouring pad of any type as this will cause excessive wear on the plated finish.

MADINOZ PRODUCT RECYCLING STEWARDSHIP POLICY

“With greater concerns about sustainability, designers are looking for low environmental impact solutions but do not want to compromise on aesthetics; Madinoz offers both.”

Guy Frangi, Manager
Madinouz Architectural Door Hardware
Australia

Madinouz Architectural Door Hardware, the highly regarded Australian manufacturer of stylish and premium quality door hardware, is very pleased to comply with **The Good Environmental Choice Australia Label (GECA)** which indicates the environmental performance of a product from multi-criteria and a whole of the product life perspective. Products certified by GECA provide Green Star accredited professionals with the right resources for their Green Star projects.



To move towards sustainable consumption buyers need to recognise which products and services have preferable environmental outcomes.

Madinouz is committed to undertaking a **Product Recycling Stewardship Program**, under which all brass and stainless steel components manufactured by Madinoz can be returned through the selected distributor for recycling at the end of product life. Madinoz ensures that all brass or stainless steel hardware, fittings, handles and accessories returned at product end of life will be recycled through relevant resource recovery networks and will not end up in Landfill*.

No other costs are chargeable to the consumer apart from transport cost to the Madinoz facility at Unit 3/1-7 Ada Avenue, Brookvale NSW 2100.

Please contact your distributor of Madinoz products to arrange return of goods. A tax receipt or some other documentary evidence from the original purchase must be retained in order to facilitate resource recovery.

WHY IS RECYCLING AND REDUCING THE IMPACT OF LANDFILL WASTE ON OUR ENVIRONMENT IMPORTANT?

The impacts of Landfill waste are a contributor to climate change.

The International Panel for Climate Change (IPCC) Fourth Assessment Report (2007) established that is highly confident that anthropogenic impacts such as the burning of fossil fuels and a 'disposable lifestyle culture' are the reasons for climate change.

Australia disposes of 32 million tonnes of solid waste into Landfill every year. 40% of this is attributable to the Construction and Demolition sector (Australian Bureau of Statistics, 2002-03).

Results from a Department of Environmental and Climate Change (DECC) study in 2004-05 showed that there are opportunities for up to 40% of the Construction & Demolition waste disposed to Landfill in the Sydney Metropolitan Area. The study estimated 30,000 tonnes of this was ferrous metals.

In recognising the critical role that the building industry plays in climate change in creating it and solving it, attaining the Good Environmental Choice Australia label and providing a Product Recycling Stewardship Policy is our way of moving towards sustainable consumption and being part of the solution.

For further information please contact Madinoz.

Unit 3 / 1-7 Ada Avenue, Brookvale NSW 2100 Australia

Telephone: **(02) 9939 2007**

Facsimile: (02) 9939 8432

E-mail: sales@madinoz.com.au

Website: www.madinoz.com.au

Vision range is also available with privacy button on round rose & square rose

Material Solid Zinc Die-cast

madinoz MDZ 888-1

FINISH AVAILABLE IN SC PC BK



ROUND ROSE

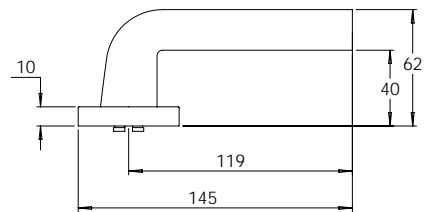
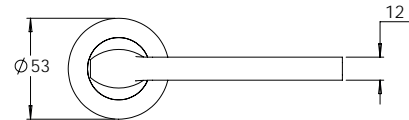

SQUARE ROSE

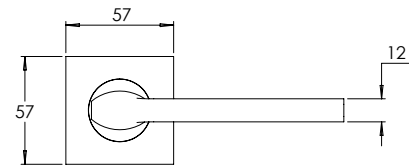

madinoz MDZ 888-1BLK



madinoz MDZ 888-6

FINISH AVAILABLE IN SC PC BK



ROUND ROSE

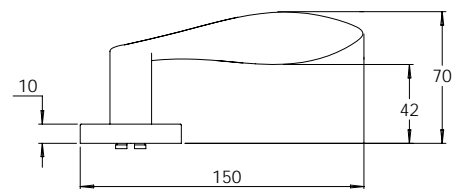
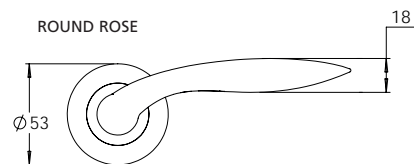

SQUARE ROSE

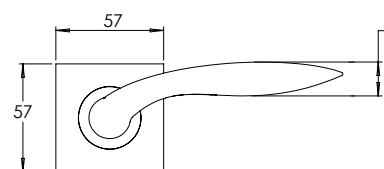

madinoz MDZ 888-6BLK



Vision range is also available with privacy button on round rose & square rose

Material Solid Zinc Die-cast

madinoz MDZ 888-8

FINISH AVAILABLE IN SC PC BK



SC - SATIN CHROME



ROUND ROSE

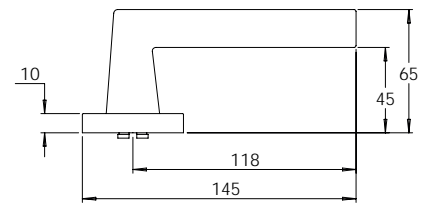
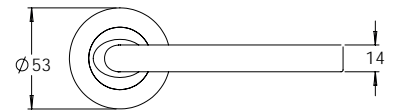

SQUARE ROSE

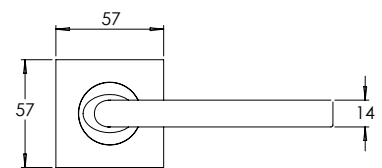

madinoz MDZ 888-8BLK



BK - SATIN BLACK

madinoz MDZ 888-9

FINISH AVAILABLE IN SC PC BK



SC - SATIN CHROME



ROUND ROSE

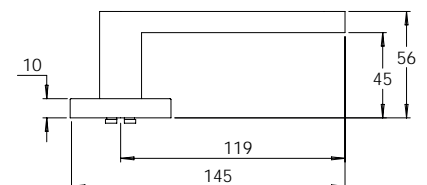
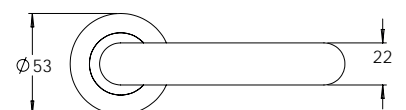

SQUARE ROSE

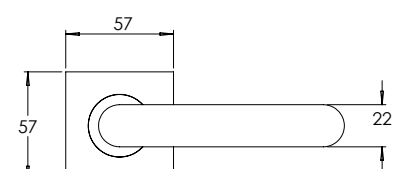

madinoz MDZ 888-9BLK



BK - SATIN BLACK

Vision range is also available with privacy button on round rose & square rose

Material Solid Zinc Die-cast

madinoz MDZ 888-10

FINISH AVAILABLE IN SC PC BK

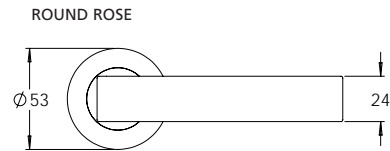

madinoz MDZ 888-10BLK

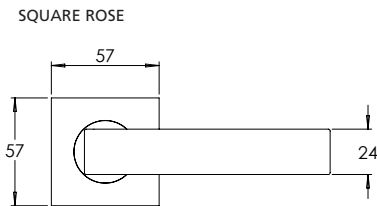
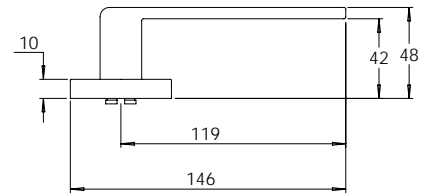

madinoz MDZ 888-12

FINISH AVAILABLE IN SC PC BK

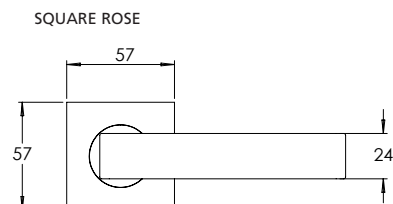
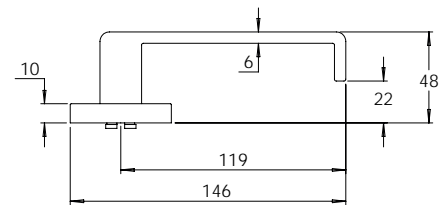
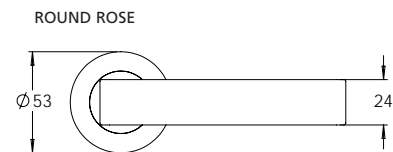

madinoz MDZ 888-12BLK



Vision range is also available with privacy button on round rose & square rose

Material Solid Zinc Die-cast

madinoz MDZ 888-14

FINISH AVAILABLE IN SC PC BK



SC - SATIN CHROME



ROUND ROSE

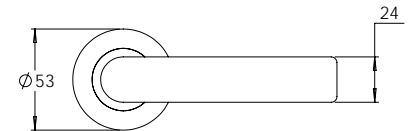

madinoz MDZ 888-14BLK



BK - SATIN BLACK

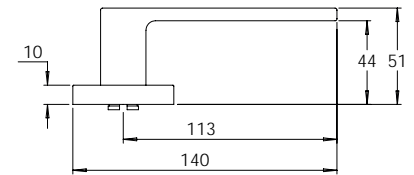

SQUARE ROSE

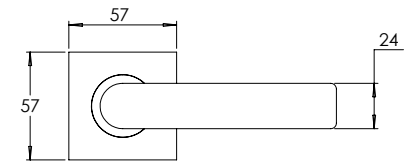

madinoz MDZ 888-16

FINISH AVAILABLE IN SC PC BK



SC - SATIN CHROME



ROUND ROSE

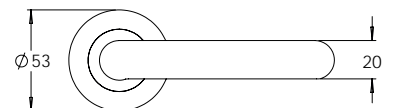

madinoz MDZ 888-16BLK



BK - SATIN BLACK

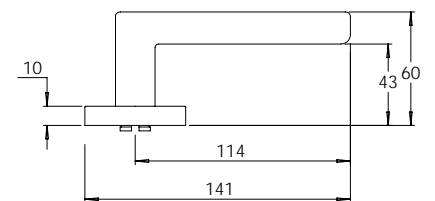

SQUARE ROSE

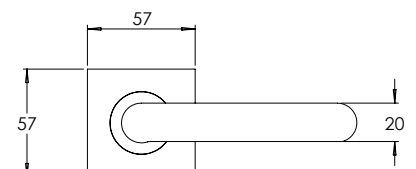

Vision range is also available with privacy button on round rose & square rose

Material Solid Zinc Die-cast

madinoz MDZ 888-17

FINISH AVAILABLE IN SC PC BK



ROUND ROSE

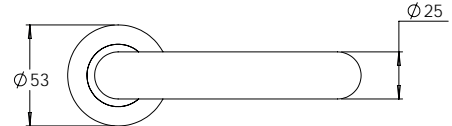

madinoz MDZ 888-17BLK

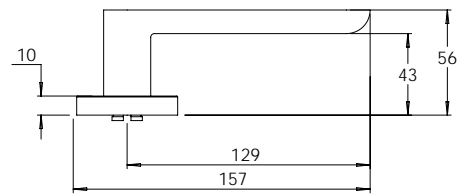

SQUARE ROSE

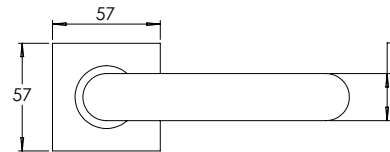

madinoz MDZ 888-18

FINISH AVAILABLE IN SC PC BK



ROUND ROSE

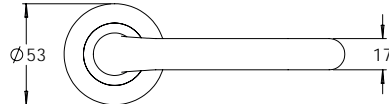

madinoz MDZ 888-18BLK

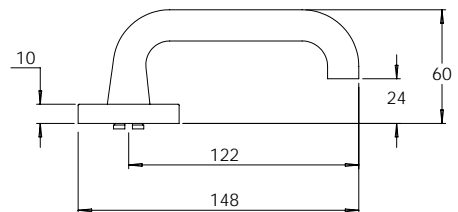

SQUARE ROSE

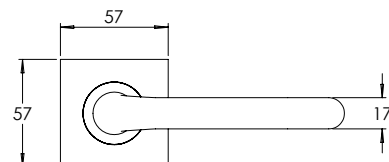

Vision range is also available in square rose

Material Solid Zinc Die-cast

VISION Lockset Accessories

FINISH AVAILABLE IN SC PC BK



SC - SATIN CHROME



888-EU



888-OC



888-TT



888-ER



888-BRBLK



888-OCBLK

BK - SATIN BLACK



888-TTBLK



888-ERBLK

Our Compact Quality Solution for Standard Doors Assured.

Door control systems by dorma+kaba are intelligent, integrated access solutions that combine consistency, convenience, design and premium quality. The wide-ranging product portfolio satisfies a broad spectrum of functional requirements and thus offers solutions for almost any individual door situation.



Data and features	TSO 79	TSO 400	TSO 500
Spring strength (adjustable by size by power shoe and templating position)	EN 2/3/4	EN 3	EN 3-5
Maximum dimension of door	≤ 1100 mm	< 950 mm	< 1250 mm
Fire doors	•	•	•
Non-handed	•	•	•
Arm type standard scissor arm	•	–	–
Arm type standard slide arm	–	•	•
Closing speed adjustable	180° – 15°	•	•
Latching action adjustable	15° – 0°	•	•
Backcheck adjustable	70° – 180°	•	•
Hold-open	o	o	o
Approved to AS1905 Fire Resistant Doors	•	•	•
Opening limiter	o	o	o

• YES – NO o OPTION

TSO 79

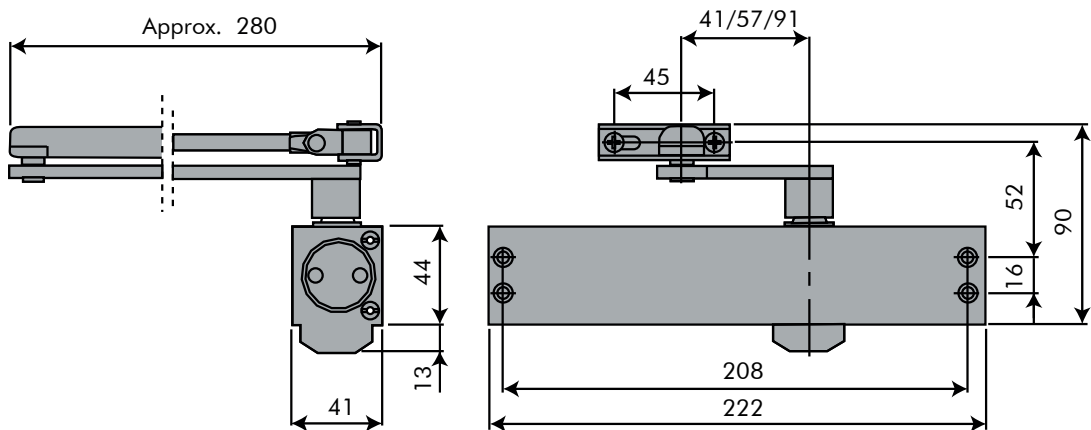

TSO 400

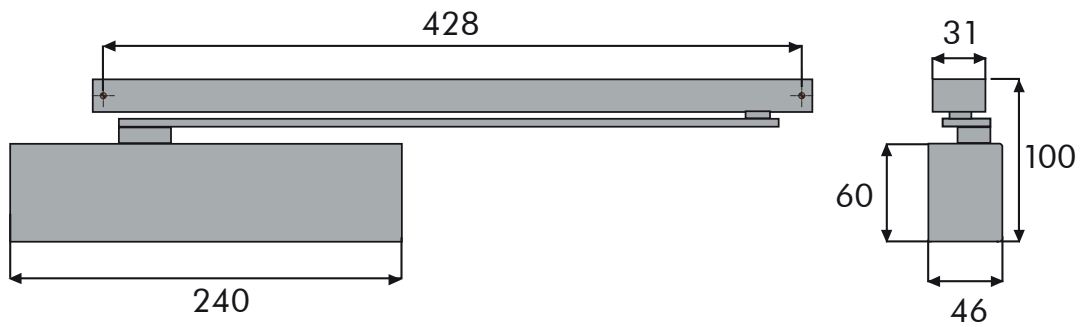

TSO 500

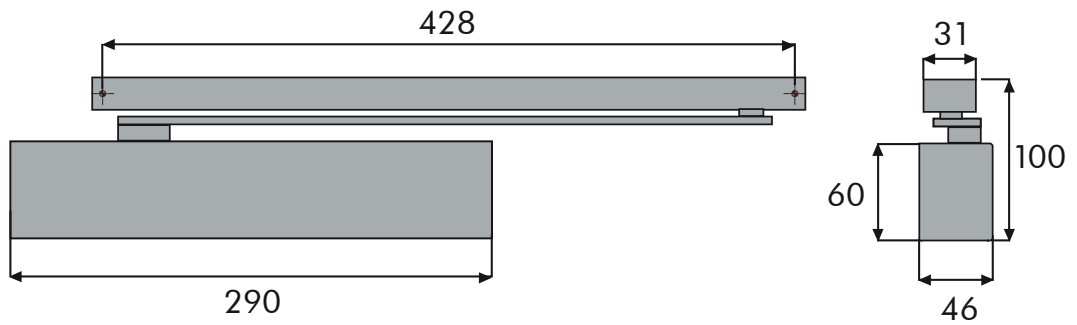



For further information please contact Madinoz.
Unit 3 / 1-7 Ada Avenue, Brookvale NSW 2100 Australia
Telephone: **(02) 9939 2007**
Facsimile: (02) 9939 8432
E-mail: sales@madinoz.com.au
Website: www.madinoz.com.au