



## Product Catalogue **115**<sub>v1.6</sub>

Weather and Energy  
Fire and Smoke  
Noise - Acoustic  
Light  
Insects - Vermin

[www.raven.com.au](http://www.raven.com.au)

CELEBRATING  
**68**  
YEARS  
EST. 1950





General



Weather and Energy



Health and Aged Care



Fire and Smoke



Noise - Acoustic



Door Bottom Seals  
Threshold Plates



Door Frame /  
Perimeter Seals



Other Products

**Raven Products Pty. Ltd.**

**Head Office and Factory**

18 - 22 Aldershot Road  
Lonsdale, South Australia 5160  
Australia

PO Box 67  
Lonsdale, South Australia 5160  
Australia

**T** +61 8 8384 5455

**F** +61 8 8382 8885

**Sales Enquiries**

**T** 1800 888 123 Free call anywhere in Australia

**E** sales@raven.com.au

**Technical Advice**

**E** tech.advice@raven.com.au

[www.raven.com.au](http://www.raven.com.au)

© Raven Products 2018



Cert. No. AU96/678



**IDWV**  
INTERNATIONAL  
DOOR & WINDOW  
LABORATORIES



About Raven .....	2
International Research and Development .....	4
Using This Catalogue .....	6
Standards / Authorities .....	114
Quick Product Reference .....	116
Product Index .....	120
Building Code Regulations .....	9
Butt Hinged Doors - Timber and Aluminium .....	10
Pivot Doors - Timber and Aluminium .....	11
Sliding Doors .....	12
Garage Doors - Panel-lift and Roll-up .....	12
Folding Doors .....	13
Butt Hinged Doors .....	15
Pivot Doors .....	16
Building Code Regulations .....	19
Introduction and Reference Standards .....	20
Smoke Door Sealing Systems - Solid Core Doors .....	21
Smoke Door Sealing Systems - Fire Engineered - Alternative Solutions .....	24
Smoke Sealing Systems - Fire Rated (Labelled) Doors .....	26
Bushfire - Sealing Systems - Ember Attack .....	28
Intumescent Fire Seals .....	95
Building Code Regulations .....	31
Solid Core Doors .....	32
Bulkhead .....	38
Acoustically Designed Doors .....	40
Automatic Door Bottom Seals .....	43
Door Bottom Sweep Seals .....	50
Threshold Plate Seals .....	58
Threshold Plates .....	62
Door Frame / Perimeter Seals .....	70
Astragals (Meeting Stile Seals) - Timber, Glass, Magnetic .....	85
Joinery Seals - Silicon and TPE .....	91
Self-adhesive Seals .....	94
Intumescent Fire Seals .....	95
Brush Strip Seals - Nylon Filament .....	101
Complementary Products .....	108
Replacement Components .....	112
Architectural Tactiles, Stairs Treads and Edging Solutions .....	123



## Celebrating 68 Years

Established in 1950, Raven Products is an Australian family owned and operated company that pioneered the door and window seal industry in Australasia. Raven has grown to become one of the most trusted brands in the building hardware industry providing innovative, quality tested and certified door and window sealing systems for architects, designers, engineers and builders.

The Raven brand is synonymous with quality, value and service which is why Raven is the brand that is consistently relied on and recommended here in Australia and overseas.

Raven offer a tested and certified range of door and window sealing systems for the containment of energy and the exclusion of noise, fire, smoke, vermin, insects and bushfire embers.

As a world leader in its field with products distributed across the globe, Raven's founding principals have always remained true - to provide the best products at the best price supported by the best service.

CELEBRATING  
68  
YEARS  
EST. 1950

## A Focus on Service and Advice You Can Trust

When architects, engineers and builders are faced with door and window sealing challenges in design, compliance or function, they turn to Raven.

With a long list of design and patent registrations, Raven developed much of the technology and led many of the advances in weather, acoustic and fire & smoke sealing and is why architects, designers and builders can rely on Raven for the best advice – after all, this is how many of our innovative products were born.

We have a team of specialists on hand to provide expert advice to assist with developing the most suitable and cost effective solutions to even the most challenging problems. With 68 years in manufacturing and supporting the building industry, Raven remains at the forefront; Raven understands its complexities, challenges and creative requirements.

For informative and professional support, please telephone 1800 888 123 or email our technical assistance team at; [tech.advice@raven.com.au](mailto:tech.advice@raven.com.au)

## Solutions on Your Doorstep

With modern dispatch centres in Australia and Asia, we can deliver tailored sealing systems around the corner or across the globe. Raven's advanced ISO9001 quality design and production systems can build and deliver colour matched, tailor made products weeks ahead of other manufacturers.

Our network of distributors and transport systems can deliver anywhere in the world from desert mining sites in outback Australia, mid ocean oil and gas rigs, Antarctic research stations to the bustling cities of London, Dubai or Shanghai.

So when you call on Raven to deliver the ideal sealing system – you can be sure that's exactly what we will do.

## Our Name is Your Guarantee

We will never put our name to a product until we are fully satisfied that it is not just easy to fit and highly durable, but that it can withstand the appropriate extremes and complies with the latest building code regulations and standards.

Our name and 68 year reputation is your guarantee of reliability and quality.

## Quality Control That Sets New Standards

Our commitment to quality extends from research, development and testing through to manufacture, delivery, ease of application, durability and after sales service regardless of the project size or complexity.

With a professional team of engineers, designers and international certified testing facilities; Raven is the brand that architects, designers, engineers and builders can rely on.

Every design and invention is rigorously assessed and tested to meet the most demanding Australian and international standards, including life cycle performance from the prototype phase and construction through to random batch testing of the final manufactured product. Raven maintains control over every aspect of its range carefully selecting materials and suppliers to ensure a superior end product. We also take our environmental responsibility just as seriously, operating to environmental ISO 14001 standards.

Raven's focus on innovation has provided sealing solutions for the building industry for decades. Our commitment to our products has meant the development of:

- NATA accredited laboratory testing facilities to Australian and international standards
- ISO9001 quality management accreditation
- Operates to EMS ISO14001
- OH&S AS4801
- Australian Design awards
- A library of patents and design registrations
- Ecospecifier verified





## International Research and Development

Our enduring commitment to innovation and quality keeps Raven at the industry forefront, by providing effective performance driven sealing systems that meet or exceed our clients' expectations.

Raven's international research, product development and testing facilities means we are constantly developing new and innovative ways to respond to the rapid advances in the building industry. Our specialist research and development engineers work tirelessly to meet the ongoing needs of the building industry often pre-empting new challenges and providing innovative products to suit. All Raven products are designed to comply with international building regulations and requirements. Continuous monitoring and accreditation to international quality standard ISO 9001 underscores the company's determination to deliver products that are proven to be the best.

Actively identifying advances in the industry, Raven is at the forefront, developing the technology and the products to suit. We see our role not just to design and manufacture a quality product but also to assist architects, engineers and builders to help improve building design and safety while reducing construction costs where possible.

## Compliance and Certification

Designed to meet or exceed Australian, New Zealand and European standards and building codes, Raven offer a tested and certified range of door and window sealing systems for the containment of energy the exclusion of noise, weather, insects, vermin, fire, smoke and bushfire embers.

Don't put your project at risk with products that only claim "deemed to satisfy". This means they may not have undergone the same rigorous laboratory testing and certification processes as Raven.

With in-house NATA accredited testing facilities, Raven's design and engineering team can quickly develop new and innovative ways to respond to the advances in the building industry here and around the world. Our array of patents and numerous design awards stand as testament to this commitment.

You can rest easy in the knowledge that Raven will provide you with the most tested and compliant systems available on every project.



## Internationally Accredited Testing

Raven door and window seals are tested and certified by internationally recognised accredited laboratories ensuring the highest quality and performance. Seals undergo weather, acoustic, fire and smoke testing to verify their conformance to national and international codes and regulations.

Weather testing is performed in a NATA accredited laboratory that sees door and window assemblies pelted with rain and wind pressures up to 300km per hour - that's cyclonic conditions! Weather tests on door and window assemblies are conducted in accordance with AS2047 and AS4420 series Standards.

A state of the art acoustic laboratory tests Raven sealed door sets to EN ISO 10140 series Standards with ratings to ISO 717-1.

Fire tests are performed by internationally recognised fire laboratories to Australian and International Standards AS1530.4, EN1634-1, BS 476 Pt. 20 & 22 and UL 10C.

NATA accredited laboratories test Raven seals on solid core smoke doors and fire rated door assemblies to ambient and medium temperature smoke at 200 degrees Celsius in accordance with AS1530.7 and EN1634-3 series Standards.

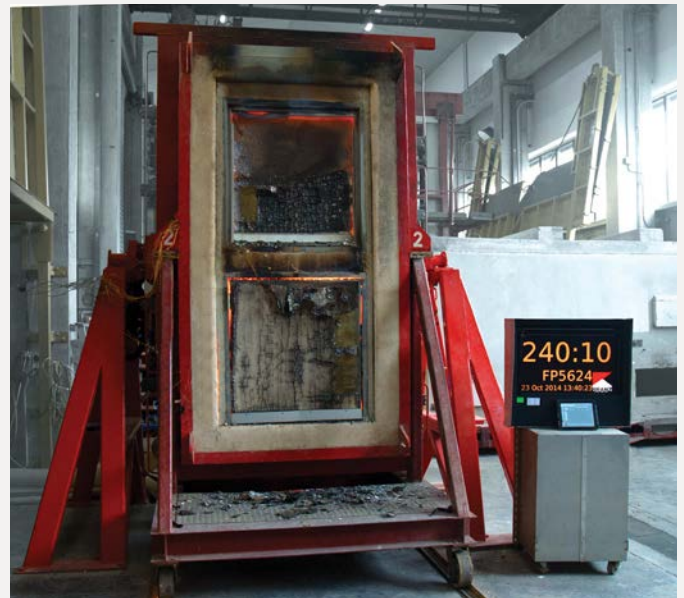

# Using This Catalogue



## The Problem

For doors and windows to function, they must have gaps between their edges and the frame to allow for easy operation and to accommodate normal building movement.

However, these gaps can allow the intrusion of draughts, dust, insects, rain, noise, vermin, fire, smoke or bushfire embers. Unsealed doors and windows allows the leakage of heating and cooling which significantly increases energy costs and reduces the energy efficiency of other design elements of a building.

## The Solution

The solution is to fit a Raven sealing system which seals the gaps around doors and windows against a combination of intrusions and leakages. Properly selected and installed, a complete and continuous seal can be achieved for all door and window types without impeding their normal use.

Optimum "sealing systems" can be achieved by combining the appropriate Raven door bottom seals, threshold plates, perimeter seals and meeting stile seals.

## Product Selection

When choosing Raven seals, you should consider:

- What type of protection is required?
- What type of door or window do you want to seal?
- Does it provide protection without impeding normal door or window function?
- Is it compatible with other door or window hardware?
- What type of duty is required?
- Is it for an external, internal, residential or a commercial situation?
- What are the building code requirements?

### Duty Levels

Raven seals have been designed to accommodate a variety of duty levels:

**L Light Duty**  
Light duty seals are generally used in residential and light traffic areas such as Class 1 – 4 Buildings.

**M Medium Duty**  
Medium duty seals are generally used in commercial and medium traffic areas such as Class 3 – 6 Buildings.

- Office spaces
- Shops
- Commercial accommodation

**H Heavy Duty**  
Heavy duty seals are generally used in heavy pedestrian and wheeled traffic areas such as Class 5 – 10 Buildings.

- Public hospitals
- Airports
- Factories
- Shopping centres

## Applications

Icons have been used to help identify appropriate seals for various applications to make product selection easier. All seals are designed to meet most standards and in most cases, perform more than one function. Refer to [page 114](#) for details.



**Weather**



**Energy, Draughts & Dust**



**Light**



**Insects and Vermin**



**Antimicrobial**

Raven gaskets and cover strips contain antimicrobial compounds. Independently tested against E. Coli, Strep and MRSA.



**Ambient (cold) Smoke**

Temperatures up to 70°C.



**Medium Temperature Smoke**

Temperatures of 200°C for 30 minutes (smoke doors).



**Fire & Hot Smoke**

Fully developed fires exceeding 600°C (intumescent seals).



**Fire (approved)**



**BAL - LOW**

Bushfire Attack Level in accordance with AS 3959.



**Up to BAL - 29**

Bushfire Attack Level in accordance with AS 3959.



**Up to BAL - 40**

Bushfire Attack Level in accordance with AS 3959.



**Up to BAL - FZ (flame zone)**

Bushfire Attack Level in accordance with AS 3959.



**Noise – Acoustic**



**Access and Mobility**

## Materials Specifications

Many seals consist of two parts; the aluminium extrusion and a flexible seal insert. Some seals also incorporate a cover strip to conceal fasteners.

**Aluminium extrusions** are alloy 6060 T5 or T6, anodised satin clear (silver) or medium bronze unless otherwise specified. Architectural perimeter seal extrusions are anodised 15µm and threshold plates are anodised 25µm for maximum durability.



Dependent on function, seal inserts can be:

- **Nylon brush filaments** - Raven nylon brush has UV inhibitors, is self-extinguishing and confirm to NCC Spec. C3.4, "Smoke Doors 200°C for 30 minutes".
- **Polypropylene pile**
- **Rigid or flexible PVC** - Raven proprietary PVC, flexible and rigid extrusions have UV inhibitors, are self-extinguishing where indicated and have a service temperature of -5°C to 70°C.
- **Silicon rubber** - Raven proprietary silicon rubber has UV inhibitors and withstands very high temperatures conforming to NCC Spec. C3.4, "Smoke Doors 200°C for 30 minutes". They are self-extinguishing with a flammability index of 1 where indicated with a service temperature of -60°C to 230°C.
- **Solid and sponge EPDM** - Raven proprietary EPDM extrusions are designed to withstand the rigours of compression, heat, cold, water, ozone, UV light, abrasion and ageing. With exceptional memory meaning they will resume their original shape even after long periods of compression, they are classified to self-extinguishing / burn rate SAE J 369, ISO 3795 where indicated and have a service temperature of -40°C to 70°C.
- **TPE (Thermo-Plastic Elastomer)** Raven proprietary TPE has similar performance characteristics of EPDM. Raven TPE has added UV inhibitors and a flammability index <5 where indicated. TPE has a service temperature of -40°C to 100°C.

## Fixing

The majority of Raven seals are fastened using supplied zinc plated, self-tapping, cross recess head screws of the appropriate size and colour. Fixing holes are usually pre-drilled and many are slotted to allow for accurate fitment and compensation for building movement.

## Painted Finishes

Raven Polyester Enamel (P.E. Paint) finish can be colour matched to virtually any colour sample for the aluminium extrusion component. P.E. Paint is a two pack polyester enamel colour match finish which outperforms most finishes including powder coating in the critical areas of colour choice, durability, flexibility and hardness. P.E. Paint is available at an extra cost and requires an additional lead time.

## Storage & Maintenance

Raven seals should be stored flat in a clean and dry area away from excessive heat.

Annual or periodic inspection, adjustment and cleaning is suggested for all styles of door and window seals. For fire and smoke sealing applications, refer to [page 114](#) for standards and authorities.

## Specifying Raven Seals

To avoid product substitution it is important to quote the brand name "Raven", the product model number, finish, preferred system configuration and reference to the Raven material specification, standards and guarantee, refer to [page 121](#).

## NATSPEC Product Partner

To further assist in creating a Raven product specification, Raven is a product partner with NATSPEC providing clear and easy to use specification templates. [www.natspec.com.au](http://www.natspec.com.au)

## Green Specification

Raven Products Pty Ltd is verified and listed with the internationally respected organisation Ecospecifier Global.

The Raven verified product listing will assist specifiers when selecting environmentally helpful and sustainable products and obtaining green building credits. [www.ecospecifier.com.au](http://www.ecospecifier.com.au)

## CAD

Detailed drawings and specifications of all Raven seals are available to registered users from the Architectural Door and Window Seal link at [www.raven.com.au](http://www.raven.com.au).

Please note: illustrations in this catalogue may not be to scale. Slight variations in extrusions may occur but these minor differences are nominal.

The latest information about Raven, including a PDF version of this catalogue is available from the Raven website [www.raven.com.au](http://www.raven.com.au).

## Product Information

Raven seals are available in stock lengths and standard door set sizes. Some rigid perimeter seals are pre-cut to suit standard door sizes (mm):

- Single – 1 x 1000 & 2 x 2100
- Double – 3 x 2100
- Long single – 1 x 1000 & 2 x 2750
- Long double – 1 x 2000 & 2 x 2750

## Ordering

In Australia, the Raven Architectural ranges of seals shown in this catalogue are available to order from specialist, Architectural Door Hardware distributors that are located in each state.

Raven architectural distributors can assist you with product sizes, finishes, pricing and delivery information in your area.

When ordering, quote how many units, the brand "Raven", model number, description, unit length and the standard finish as detailed in the catalogue, e.g. Six only "Raven RP38 door bottom seals, 920mm, clear anodised".

**Important:** For rigid perimeter seals, always try to order in door set sizes or the shortest seal length available. Long rigid lengths if ordered in small quantities, whilst well packaged, are more prone to bending during transit.

All fasteners and fitting instructions are enclosed with each product. Raven seals are suitably packaged and protected with recyclable materials.

## Special Order Paint finishes

P.E. Paint is available at an extra cost and requires additional lead time. Conditions apply. Please quote the brand, colour number and finish description.

## Returns and Allowances

No product returns are accepted without prior written permission. Conditions apply.



## Weather and Energy

*NCC Class 1 - Class 10 Buildings (residential, public buildings, shop fronts, apartments, hotels, factories and hospitals)*

Weather and energy door and window seals are designed to prevent draughts, rain water infiltration and energy loss through external doors. Raven produce a variety of seals to suit even the most severe weather conditions that can also significantly improve the thermal efficiency of a building by preventing energy loss up to 50%.

In addition, Raven door bottom and perimeter seals can also be used in conjunction with threshold plates and astragal seals to prevent the ingress of dust, insects and rodents and wind-blown embers in bushfire prone areas.

Raven have a large range of weather – energy sealing systems tested and certified to meet building code regulations as well as meeting the applicable Bushfire Attack Level (BAL) requirements in bushfire prone areas.



## National Construction Code (NCC) Requirements

### Commercial

Class 2 - Class 9 buildings

#### J3.4 Windows and doors

- (a) A seal to restrict air infiltration must be fitted to each edge of a door, openable *window* or the like forming part of—
- (i) the envelope of a *conditioned space*; or
  - (ii) the external fabric of a habitable room or public area in *climate zones 4, 5, 6, 7 and 8*.
- (b) The requirements of (a) do not apply to—
- (i) a *window* complying with AS 2047; or
  - (ii) a fire door or smoke door; or
  - (iii) a roller shutter door, roller shutter grille or other security door or device installed only for out-of-hours security.
- (c) A seal required by (a)—
- (i) for the bottom edge of an external swing door, must be a draft protection device; and
  - (ii) for the other edges of an external door or the edges of an openable *window* or other such opening, may be a foam or rubber compression strip, fibrous seal or the like.
- (d) An entrance to a building, if leading to a *conditioned space* must have an airlock, self-closing door, revolving door or the like, other than—
- (i) where the *conditioned space* has a floor area of not more than 50 m<sup>2</sup>; or
  - (ii) where a café, restaurant, open front shop or the like has—
    - (A) a 3 m deep unconditioned zone between the main entrance, including an open front, and the *conditioned space*, and;
    - (B) at all other entrances to the café, restaurant, open front shop or the like, self-closing doors.

### Residential

Class 1 and Class 10 buildings

#### 3.12.3.3 External windows and doors

- (a) A seal to restrict air infiltration must be fitted to each edge of an external door, openable *window* and other such opening—
- (i) when serving a *conditioned space*; or
  - (ii) in *climate zones 4, 5, 6, 7 and 8*, when serving a habitable room.
- (b) A *window* complying with the maximum air infiltration rates specified in AS 2047 need not comply with (a).
- (c) A seal required by (a).
- (i) for the bottom edge of an external swing door, must be a draft protection device; and
  - (ii) for the other edges of an external swing door or the edges of an openable *window* or other such opening, may be a foam or rubber compressible strip, fibrous seal or the like.

### Ember Attack - BAL Ratings

Where door sets are being specified in Bush Fire Prone areas, door seals, weather stripping and draught excluders are required to meet AS 3959 to comply with the NCC. The BAL rating is determined by the site location and the attributing factors for bushfire attack to which AS 3959 gives guidance. Attention needs to be paid to specifying to the correct BAL rating as determined by AS 3959. Refer to the selection table [page 29](#).



### Related Building Codes

There are several standards, which refer to seal properties and testing for weather - energy:

#### AUS / NZ

Requirements are noted in the Australian National Construction Code (NCC) and New Zealand NZ BC Compliance Doc. H.

#### UK / EU

Requirements are noted in the British Building Regulations Approved Document L1 & L2.

#### USA

Requirements are noted in the Building Code and the Residential Code IBC 2000.

For further details, refer to Standards / Authorities on page 114.



### Timber Butt Hinged Doors

Effective combinations of seals for weather proofing butt hinged timber doors, inward or outward opening.

Illustrations show inward opening door configurations.

### Commercial Aluminium Shop Front Doors

An effective weather - energy sealing system with disabled access for commercial shop fronts.

#### RP113 RP4FZ

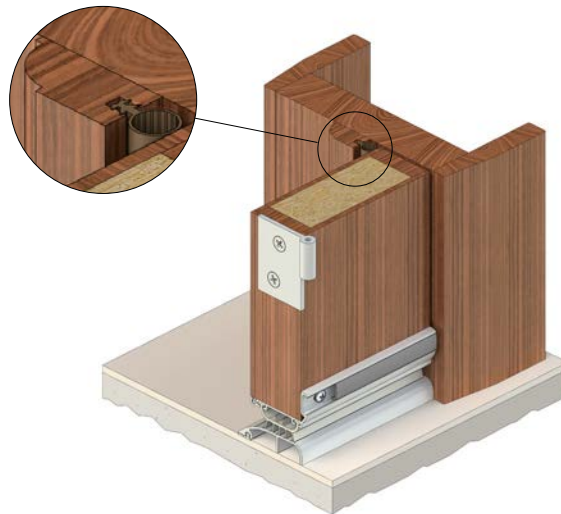

BAL  
≤40

BAL  
≤FZ  
with  
approved  
shutter/  
screen

#### RP78Si RP4 RP16Si

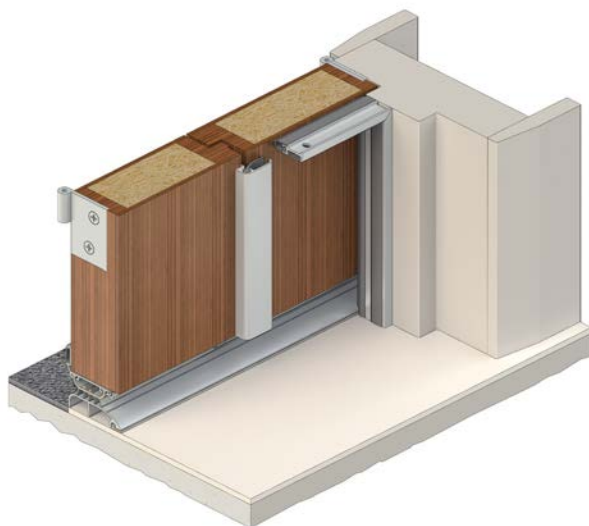

BAL  
LOW

BAL  
≤40  
with  
RP4FZ

#### RP520 RP123 RP510

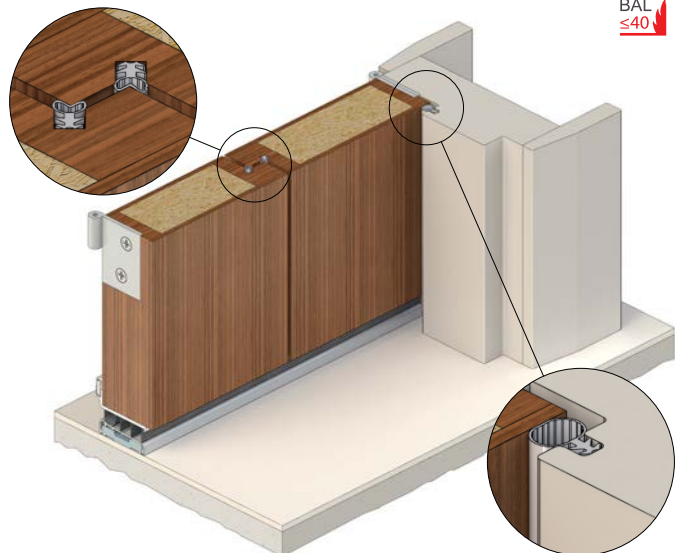

BAL  
≤40

#### RP10 RP8Si RP98

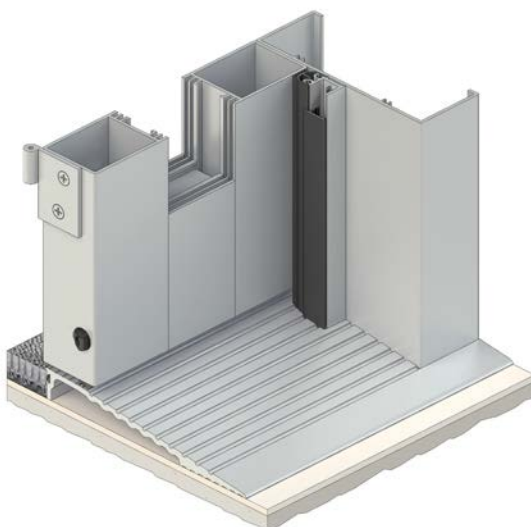

BAL  
LOW

BAL  
≤40  
with  
RP10Si

#### RP84Si RP89 RP77

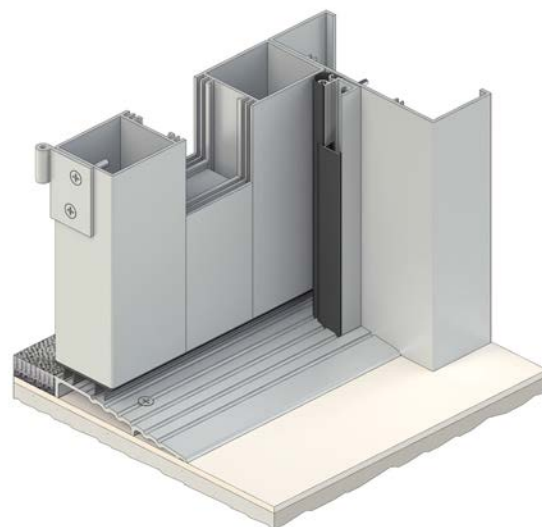

BAL  
≤29



## Pivot Doors

### Timber and Aluminium Pivot Doors

Single and double acting doors present one of the more difficult sealing problems. When a centre pivot hung door is opened, it must be considered that the leaf is travelling in two directions at once. That is to say, if a door is opened out, then that portion between the pivot and the jamb will be opening inwards. The same applies to the head of the door which means compression seals are not always practical. Sweep seals are the most effective solution in the form of brush strip strips or fins and bulb profiles made from PVC, TPE or silicon rubber to suit.

Weather and Energy

RP74F RP74F RP52F RP82

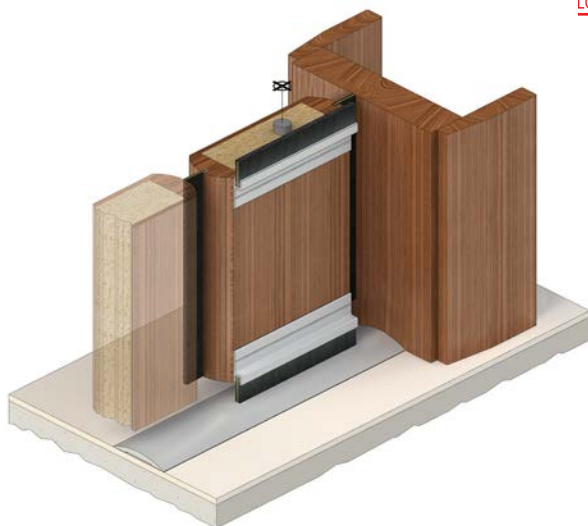

BAL  
LOW

RP130Si RP129Si RP130Si RP115

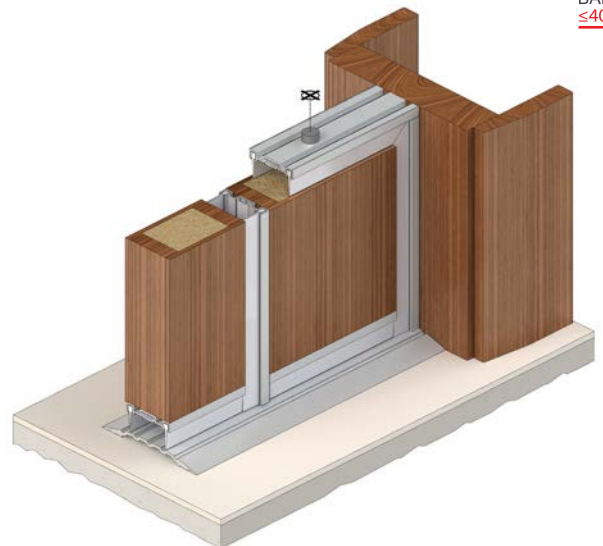

BAL  
≤40

RP89 RP89 RP116

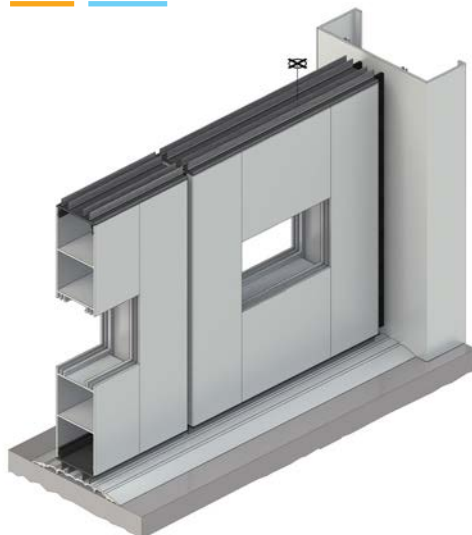

BAL  
≤29

RP74F RP74F RP19

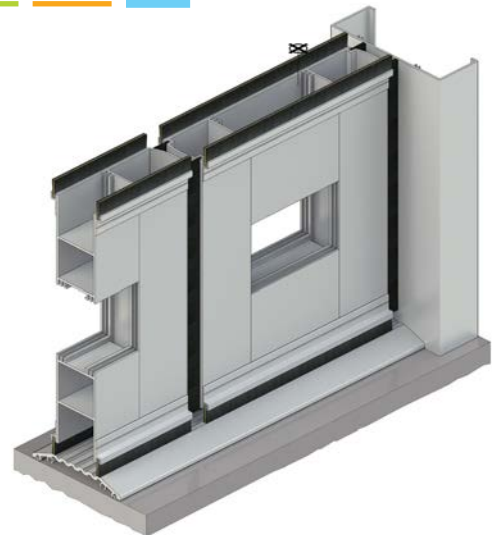

BAL  
≤29

Note: Vertical stile pile weather stripping supplied by fabricator.

Note: Vertical stile pile weather stripping supplied by fabricator.



### Sliding Doors

Sliding doors present many different sealing problems due to various types and configurations, from residential to industrial.

Effective seals for these applications are brush strip seals, sweep seals and threshold plates.

#### RP2a RP52F

BAL  
≤29

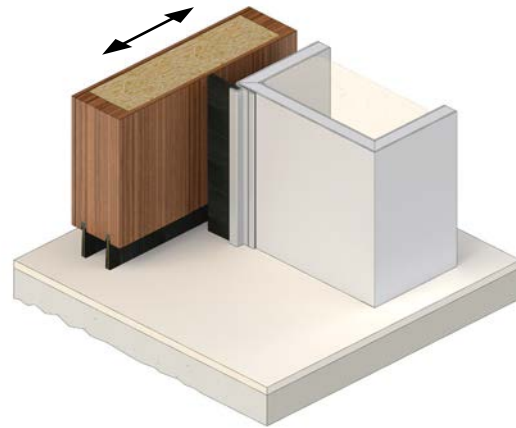

### Garage Doors

Panel-lift and roll-up garage doors present many different sealing problems due to various types and configurations, from residential to industrial.

Effective seals for these applications are brush strip seals, sweep seals and threshold plates.

#### RP74F RP74F

BAL  
≤29



#### RP73 RP17b

BAL  
LOW

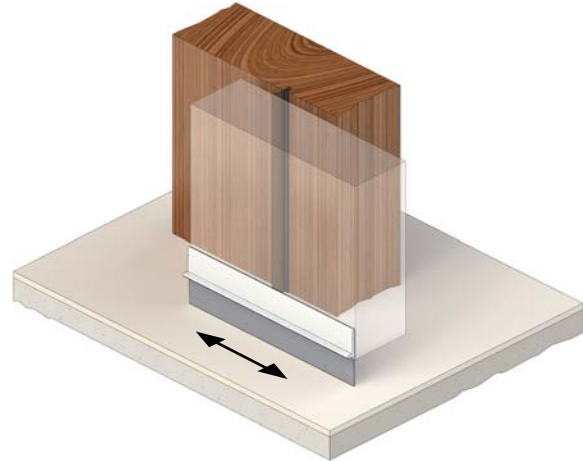

#### RP41 RP4T RP91

BAL  
≤FZ



#### RP57 RP4T RP91

BAL  
≤29

BAL  
≤FZ  
with  
RP114

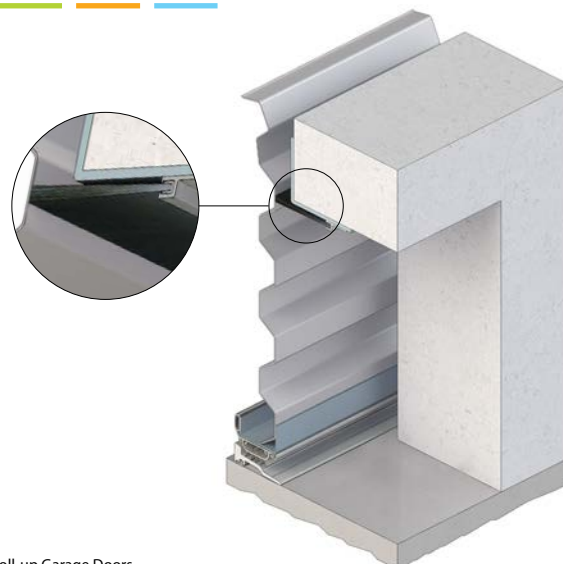

Panel-lift Garage Doors

Roll-up Garage Doors

## Folding Doors

Folding door systems have become very popular for residential and commercial applications where building space and lifestyle considerations need to be maximised. These door systems allow indoor and outdoor living space to seamlessly blend together when the weather or mood permits. However, when the weather turns bad the chosen door system needs to keep the weather out while maintaining the climate within. To do this effectively, Raven offers a joinery range of premium quality silicon and TPE weather stripping profiles that are designed to meet all sealing and regulatory performance requirements for weather, energy, noise and ember attack in bushfire prone areas.

Displayed systems have been tested to AS 2047 requirements.

*Note: Folding hardware by others.*

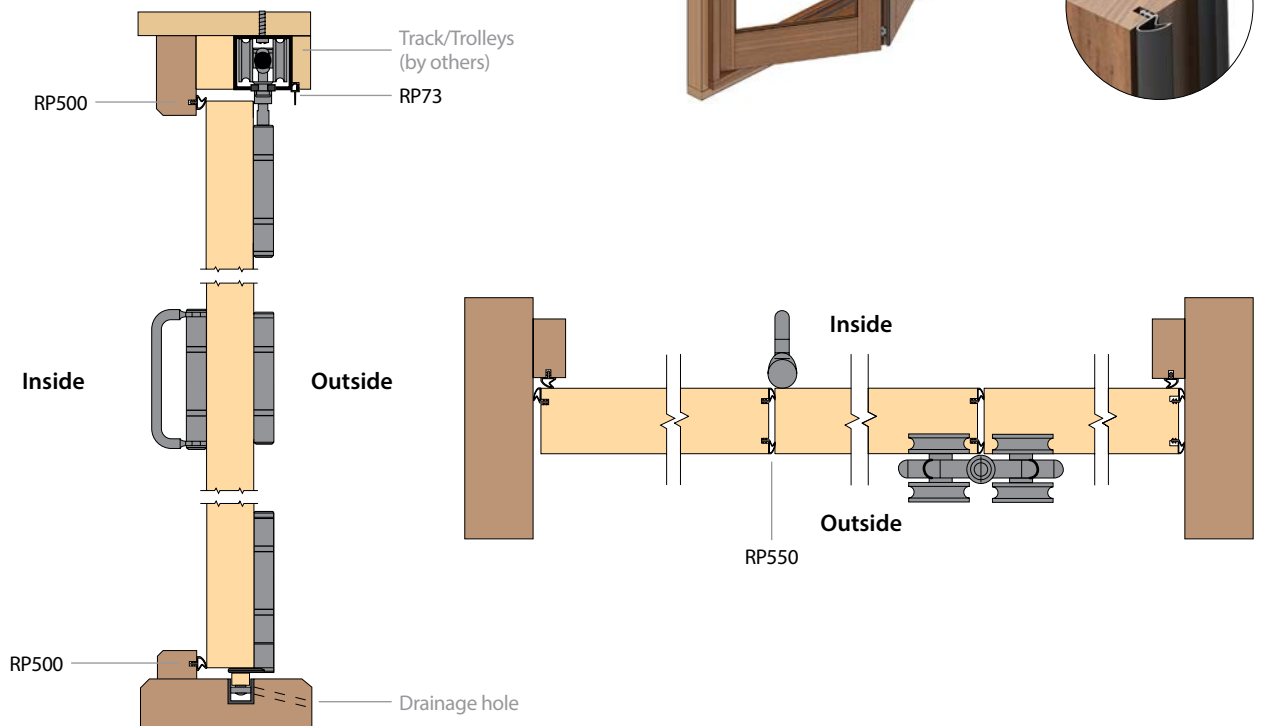

## Weather Stripping

RP500 Silicon Series refer to [page 91](#)

RP600 TPE Series refer to [page 92](#)

<b>RP500 / RP600</b>	<b>RP510 / RP610</b>	<b>RP520 / RP620</b>	<b>RP530 / RP630</b>
<b>RP540 / RP640</b>	<b>RP550</b>	<b>RP650</b>	<b>RP560 / RP660</b>



## Health and Aged Care

*NCC Class 3, Class 8, Class 9 Buildings (hospitals, medical centres, nursing homes, clean rooms, laboratories, child care centres and schools)*

Raven sealing systems for use in health and aged care applications are required to perform multiple functions such as the exclusion of weather, vermin, noise and the containment of smoke and fire. Raven seals can also help control the movement within a building of airborne pathogens.

Raven sealing systems' easy wipe down designs have gaskets and polymer cover strips that contain a Nano-tech Antimicrobial additive. These unique features, together with regular cleaning practices offer the best protection against surface bacteria around sealed doorways.



Most sealing applications but particularly in hospitals, medical and aged care facilities must meet strict building codes and standards. In some instances a "Deemed to satisfy" requirement is stated. Raven sealing systems far exceed this requirement.

Architects and building engineers are demanding higher levels of performance in a building where engineered and tested systems are required. Raven offer the largest range of engineered and certified sealing systems in the industry making Raven the brand of choice in Australia and around the world.



**RP24Si RP38Si**

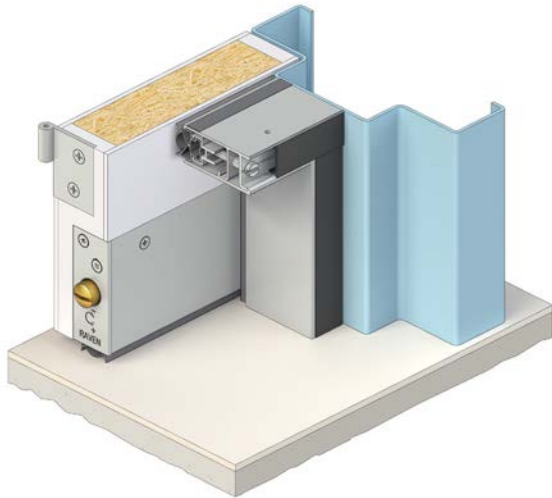

Perimeter seal adjustment independent of fixings

**RP78HSi RP8Si**

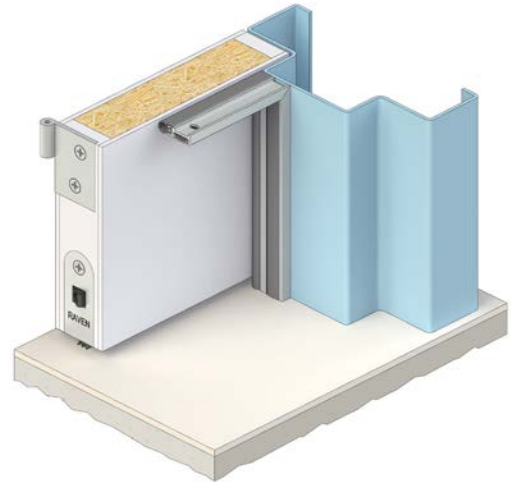

**RP87HSi RP126Si**

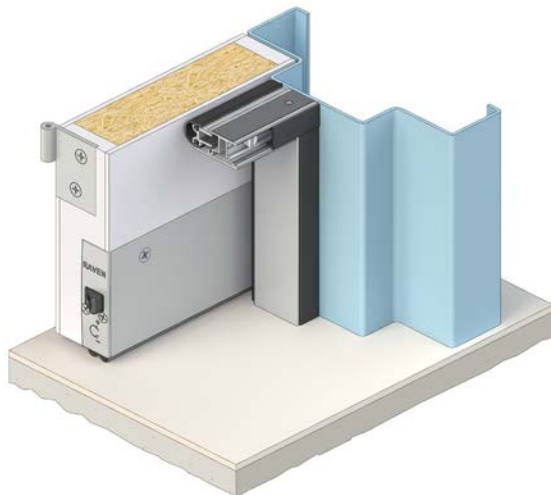

Perimeter seal adjustment independent of fixings

**RP87HSi RP128Si**

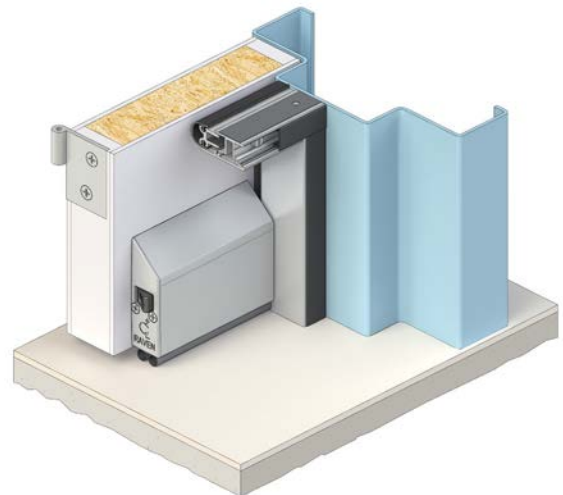

Perimeter seal adjustment independent of fixings

**RP84Si RP126Si RP71Si**

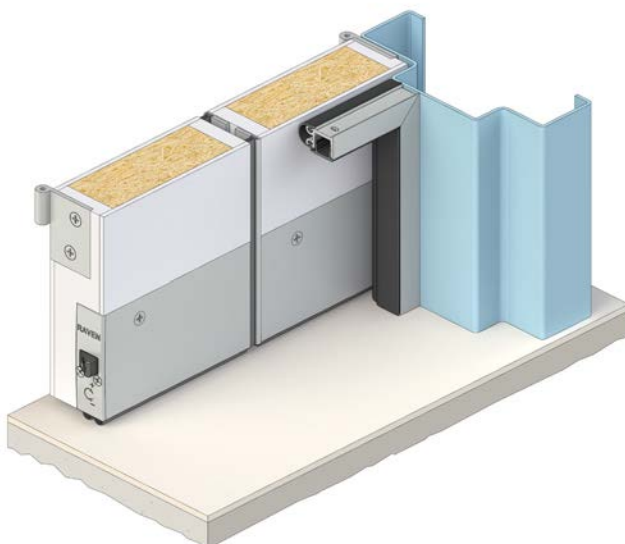

**RP124 RP127Si RP71Si**



RP71Si RP71Si RP71Si RP96

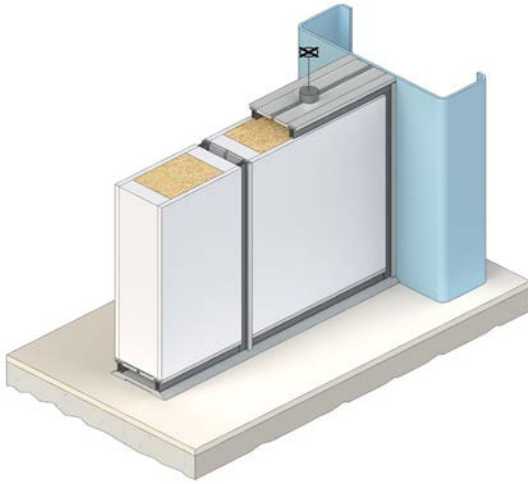

RP130Si RP52F

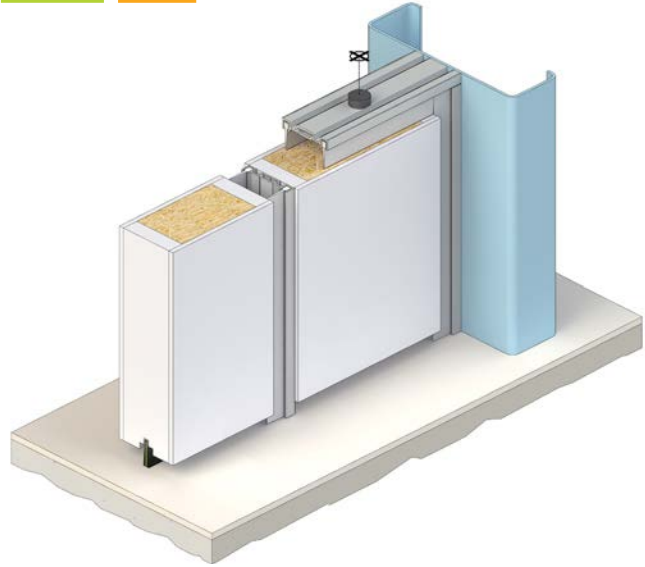

RP130Si RP129F RP130Si

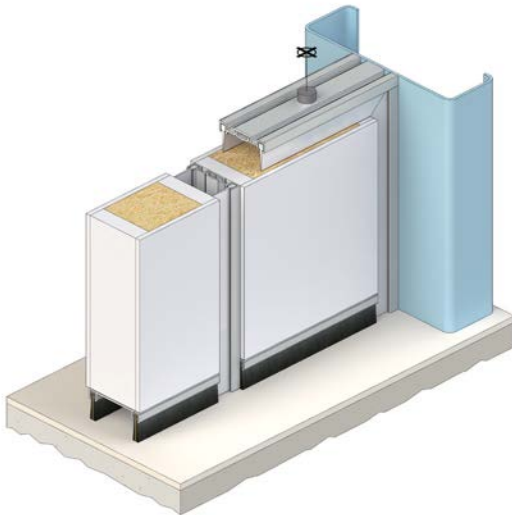

RP130Si RP129Si RP130Si RP96

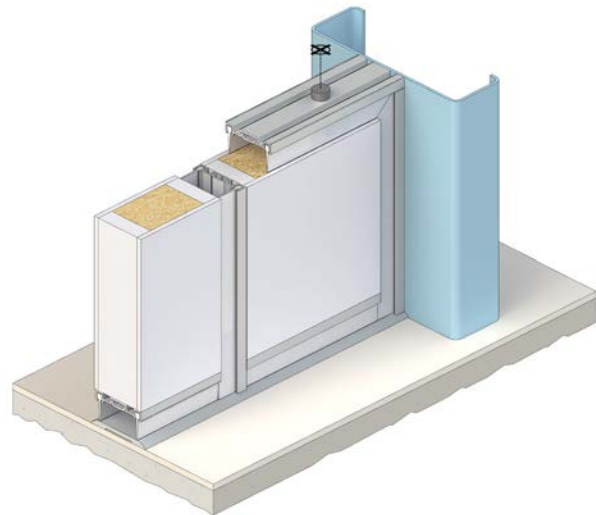





## Smoke Door Sealing Systems

*NCC Class 2 - Class 9 Buildings (hospitals, aged care facilities, hotels, high rise apartments and shopping centres)*

In the event of a fire emergency, life and safety is the most critical requirement for the occupants of a building. Ambient (cold) and Medium temperature smoke that is generated by a fire must be contained quickly in order to provide safe areas within a building.

Smoke compartmentation is a mandated requirement of the Australian NCC and most building codes and regulatory authorities overseas. Smoke sealing, "Smoke Doors" (solid core doors) helps provide a physical barrier that impedes the spread of toxic fumes and smoke from one room to another. Smoke sealed doors also helps protect egress routes allowing occupants a safe passage when exiting the building during a fire alarm emergency.

Raven pioneered smoke door sealing systems, their design effectively reduces smoke leakage around the door margins of smoke doors including applications that require fire rated door assemblies. Raven sealing systems comprise perimeter seals, meeting stile seals and door bottom seals. All are tested and certified to the applicable Australian and International standards.

In Australia, smoke doors and the use of fire rated doors are required to be smoke sealed to limit the leakage of ambient (cold) smoke and medium temperature smoke up to 200 degrees Celsius for 30 minutes. Refer NCC Sect. C3. Spec. C3.4. In addition to the "deemed to satisfy" requirements, Raven has tested and certified its smoke sealing systems to AS 1530.7 and EN 1634-3.

### AUS National Construction Code (NCC) Spec. C3.4

*Class 2 - Class 9 buildings*

#### 3.2 Construction deemed-to-satisfy

A smoke door of one or two leaves satisfies Clause 3.1 if it is constructed as follows;

- (a) The leaves are side-hung to swing—
  - (i) in the direction of egress; or
  - (ii) in both directions.
- (b) (i) The leaves are capable of resisting smoke at 200°C for 30 minutes.
- (ii) Solid-core leaves at least 35mm thick satisfy (i).
- (c) The leaves are fitted with smoke seals.
- (d) (i) The leaves are normally in the closed position; or
- (ii) (A) the leaves are closed automatically with the automatic closing operation initiated by smoke detectors, installed in accordance with the relevant provisions of AS1670.1, located on each side of the doorway not more than 1.5 m horizontal distance from the doorway; and
- (B) in the event of power failure to the door, the leaves fail-safe in the closed position.
- (e) The leaves return to the fully closed position after each manual opening.
- (f) Any glazing incorporated in the door complies with AS 1288.
- (g) (i) If a glazed panel is capable of being mistaken for an unobstructed exit, the presence of the glass must be identified by opaque construction.
- (ii) An opaque mid-height band, mid-rail or crash bar satisfies (i).

### NZ Building Code Compliance Document

#### Clauses C1, C2, C3, C4 Fire Safety

##### Smoke control door

A door set with close fitting single or multi-leaves which are impermeable to the passage of smoke, fitted with smoke seals and installed within a smoke separation. The door, in the event of smoke, if not already closed, will close automatically and be held closed.

#### 6.19.2 Door sets which are required to be:

- (a) Fire doors, shall comply with Paragraph C8.1 of Appendix C.
- (b) Smoke control doors shall, except as required by Paragraph 6.19.4, comply with Paragraph C8.1 of Appendix C. Smoke seals shall be fitted at the head and all vertical edges in the gaps between the door leaf or leaves and the frame, and between leaves in multi-leaf door sets.

**Clause 6.19.6** Door sets shall be clearly marked to show their FRR and where required to show their smoke stopping capability.

Comment: A door marked -/60/30 Sm would be a fire door with an integrity of 60 minutes, and an insulation of 30 minutes, which may be used as a smoke control door. A door marked -/-/ Sm would be a smoke control door only, with no FRR.

### UK / EU Building Regulations

Within Approved Document B, certain door sets within a building are identified as where smoke control door sets are required; tested to BS 476 Section 31.1 or EN1634-3 1983 Method for measuring smoke penetration through door sets and shutter assemblies. Those door sets identified as smoke control doors designated by a S after the fire rating, i.e., FD30S, FD60S etc., should have a leakage rate not exceeding 3 m<sup>3</sup>/m/h from the head and jambs when tested at 25 Pa pressure.



### Related Building Codes

There are several standards, which refer to seal properties and testing for fire and smoke:

#### AUS / NZ

Requirements are noted in the Australian National Construction Code (NCC) and New Zealand NZ BC Compliance Doc. C.

#### UK / EU

Requirements are noted in the British Building Regulations Approved Document B.

#### USA

Requirements are noted in the Building Code and the Residential Code IBC 2000.

For further details, refer to Standards / Authorities on page 114.

### Smoke Doors

#### Selecting the correct sealing system

Smoke seals are designed to contain smoke within a room or corridor and can be a combination of mechanical, compression and sweep seals.

#### Ambient (Cold) Smoke

Smoke that has come down to ambient temperature after drifting from the fire can be a life threatening concoction. The majority of Raven door seals contain cold smoke and therefore can be used to upgrade existing doors. Seals are normally tested to AS 1530.7 and EN 1634-3 (BS 426 Sect. 31.1). Smoke leakage rates from these standards of up to 3 m<sup>3</sup>/m/h of the door perimeter gap at 25 pascals excluding the threshold, is normally required. Raven seals easily exceed this criteria.

#### Medium Temp. Smoke

Smoke doors require seals to withstand greater temperatures (200 degrees Celsius for 30 minutes) to conform to the NCC specification C3.4 requirement for "Smoke Doors". Medium temperature smoke seals are required where the smoke is closer to the source of the fire and consequently at a higher temperature.

Sealing components are generally made from extruded silicon or tested high temperature PVC's and TPE's, and in the case of brush strip seals, nylon with a high temperature resistant barrier fin.

### Smoke Seal Testing

Raven smoke seals are tested in accordance with AS/NZS 1530.7 & BS EN 1634-3. The seals are required to meet accepted smoke leakage rates at various pressure differentials.

Tested systems to AS 1530.7 meeting the smoke leakage rates specified in AS 6905 Pt. 2.4 parts (a) & (b) meet the requirements of NCC specification C3.4 Deemed-to-Satisfy, i.e. smoke door assemblies having been exposed for 30 minutes or greater at 200°C, with leakage rates of up to 25 m<sup>3</sup>/h at 25 Pa for single doors and 40 m<sup>3</sup>/h for pairs of doors. Leakage rates are corrected to standard reference conditions. These leakage rates or better are commonly specified in fire engineered solutions. Raven have many tested solutions on proprietary doors to meet these requirements.

In the UK and EU Sa and Sm ratings to BS EN 13501-2 may be required. These ratings require tested smoke door assemblies to have met the leakage rates of up to 3 m<sup>3</sup>/m/h of the door perimeter gap at 25 Pa for ambient temperatures "Sa". For medium temperature 20 m<sup>3</sup>/h for single doors and 30 m<sup>3</sup>/h for pairs of doors at a pressure differential of 50 Pa at 200°C "Sm". Tests are conducted to EN 1634-3.



# Smoke Door Sealing Systems

Tested and Certified on Solid Core Doors



Effective combinations of smoke and acoustic seals tested on solid core doors that meet the requirements for AUS NCC specification C3.4 Deemed-to-Satisfy for smoke doors, UK Approved Document B and NZ Building Code Compliance Document C/AS1 Pt. 6.19.2 (b). These systems meet the leakage rates specified in AS 6905 when the door assembly is installed to AUS NCC specification C3.4 Deemed-to-Satisfy for smoke doors. Meets leakage rates specified in BS EN 13501-2 "Sa", "Sm" classification.

## Single Doors

These systems have been smoke leakage performance tested to:

AS 1530.7  $\leq 25\text{m}^3/\text{h}$  @ 25 Pa when exposed to  $200^\circ\text{C} > 30$  minutes in accordance with AS 6905.

EN 1634-3  $\leq 3\text{m}^3/\text{h}/\text{m}$  @ 25 Pa for ambient and  $\leq 20\text{m}^3/\text{h}$  @ 50 Pa for medium temperature in accordance with BS EN 13501-2.

### RP10Si RP8Si

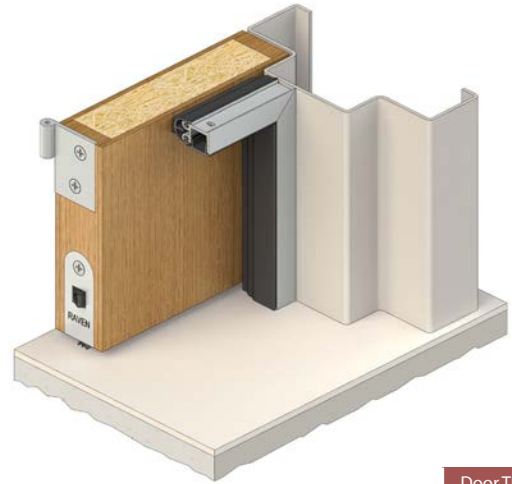

Door Thickness  
 $\geq 35\text{mm}$

### RP23 RP8Si

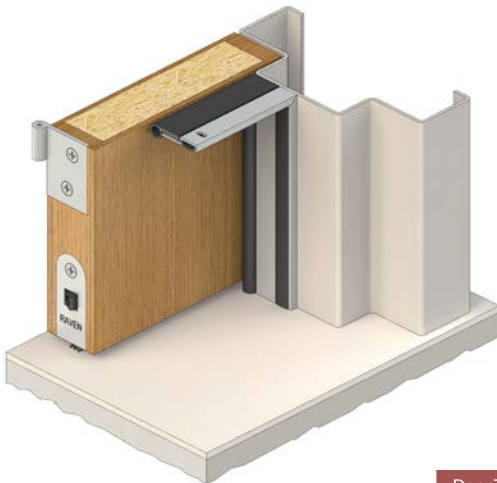

Door Thickness  
 $\geq 35\text{mm}$

### RP78Si RP8Si

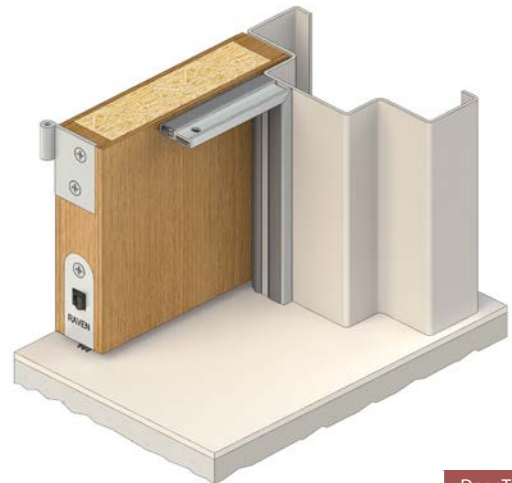

Door Thickness  
 $\geq 35\text{mm}$

### RP78Si RP35Si

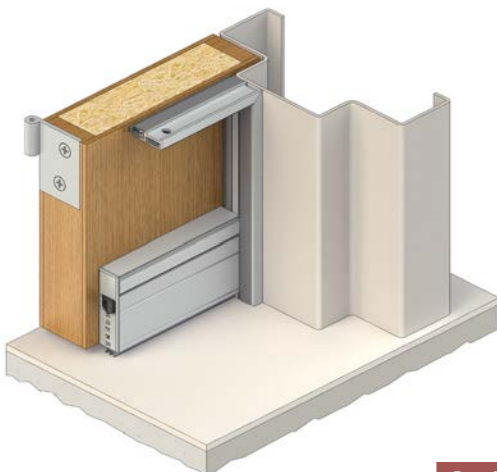

Door Thickness  
 $\geq 35\text{mm}$

### RP78Si RP38Si

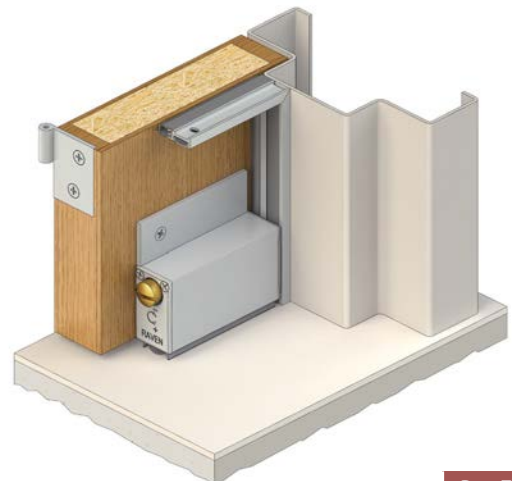

Door Thickness  
 $\geq 35\text{mm}$

# Smoke Door Sealing Systems

Tested and Certified on Solid Core Doors



## RP78Si RP128Si / RP126Si

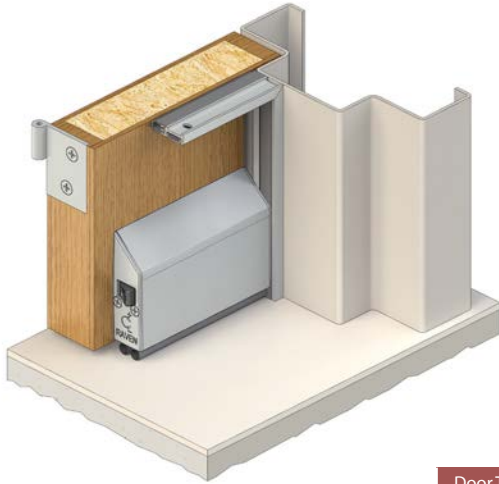

Door Thickness  
≥35mm

## RP120 / RP150 RP85i

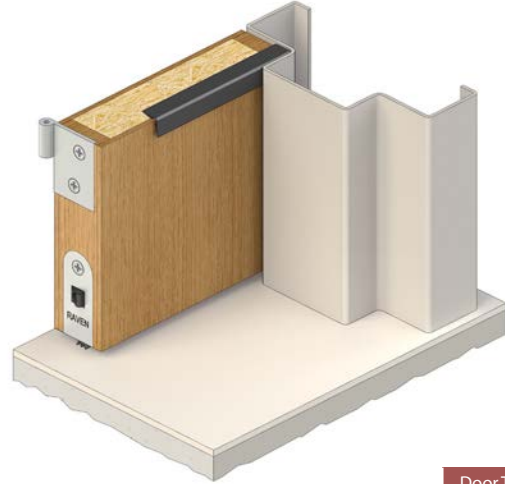

Door Thickness  
≥35mm

## RP124 RP126Si / RP128Si

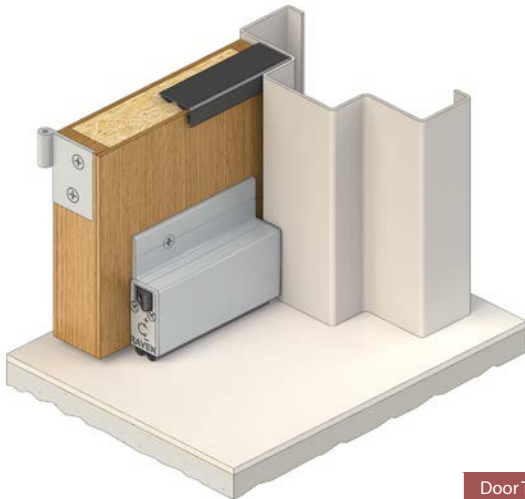

Door Thickness  
≥35mm

## RP24Si RP38Si

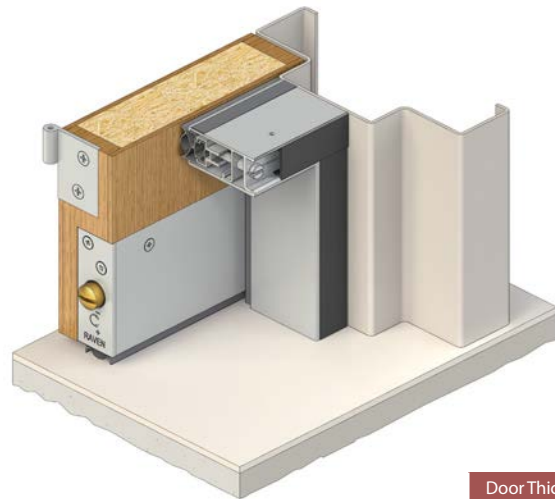

Door Thickness  
≥40mm

Perimeter seal adjustment independent of fixings

## RP87Si RP126Si

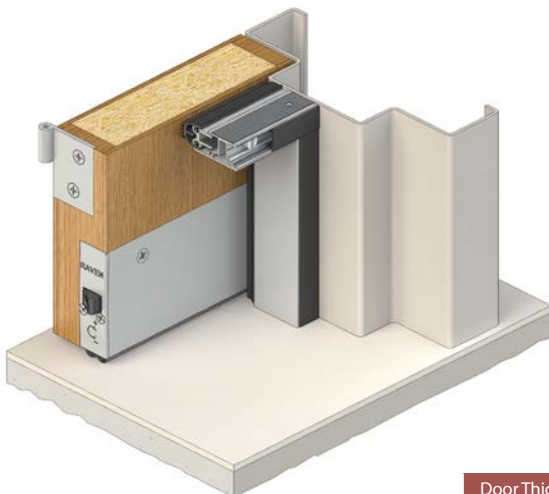

Door Thickness  
≥40mm

Perimeter seal adjustment independent of fixings

## RP124 RP127Si

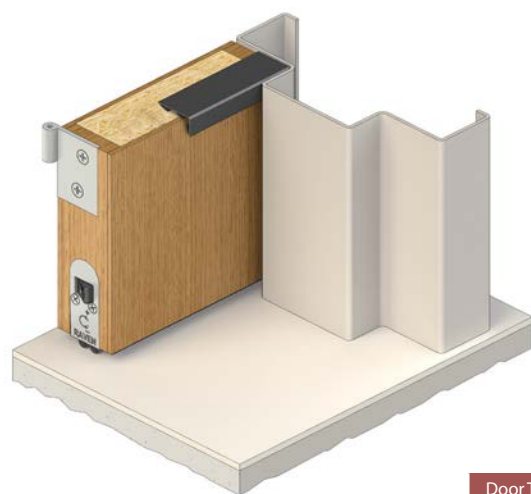

Door Thickness  
≥40mm



# Smoke Door Sealing Systems

Tested and Certified on Solid Core Doors



Effective combinations of smoke and acoustic seals tested on solid core doors that meet the requirements for AUS NCC specification C3.4 Deemed-to-Satisfy for smoke doors, UK Approved Document B and NZ Building Code Compliance Document C/AS1 Pt. 6.19.2 (b). These systems meet the leakage rates specified in AS 6905 when the door assembly is installed to AUS NCC specification C3.4 Deemed-to-Satisfy for smoke doors. Meets leakage rates specified in BS EN 13501-2 "Sa", "Sm" classification.

## Pairs of Doors

These systems have been smoke leakage performance tested to:

AS 1530.7  $\leq 40\text{m}^3/\text{h}$  @ 25 Pa when exposed to  $200^\circ\text{C} > 30$  minutes in accordance with AS 6905.

EN 1634-3  $\leq 3\text{m}^3/\text{h}/\text{m}$  @ 25 Pa for ambient and  $\leq 30\text{m}^3/\text{h}$  @ 50 Pa for medium temperature in accordance with BS EN 13501-2.

### RP78Si RP38Si RP16Si

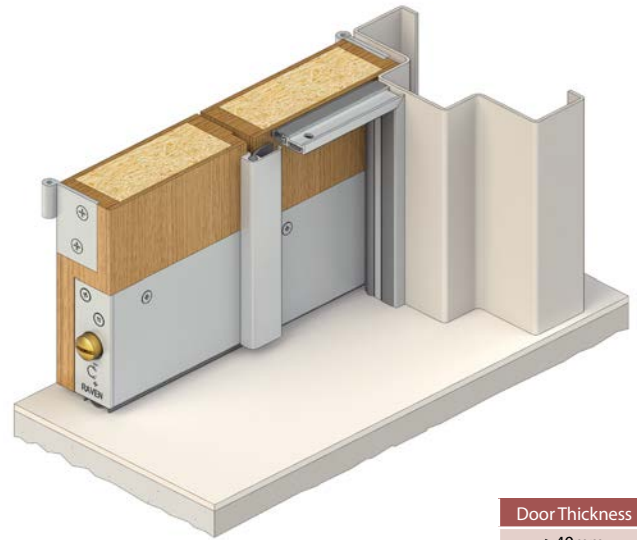

### RP120 RP8Si RP120

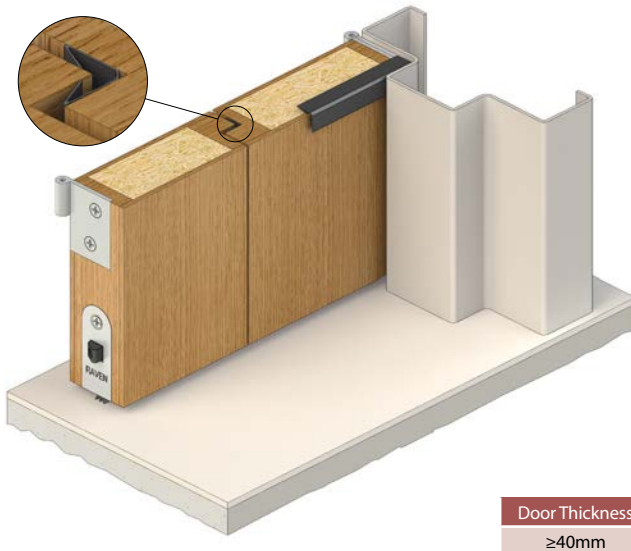

### RP124 RP35Si RP71Si

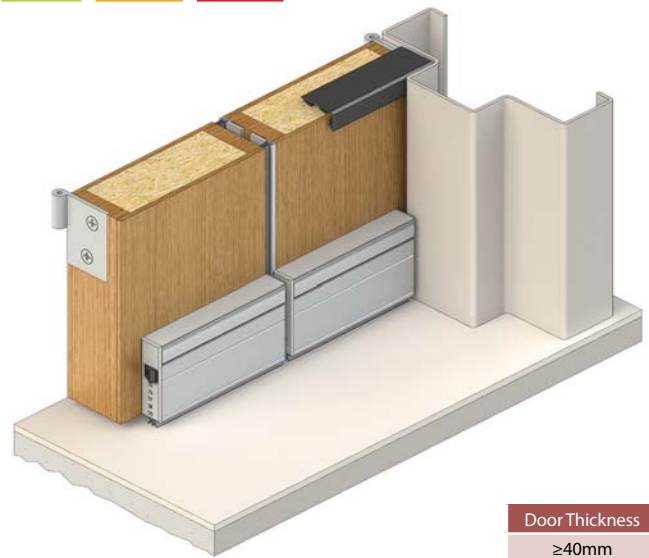

### RP150 RP8Si RP150

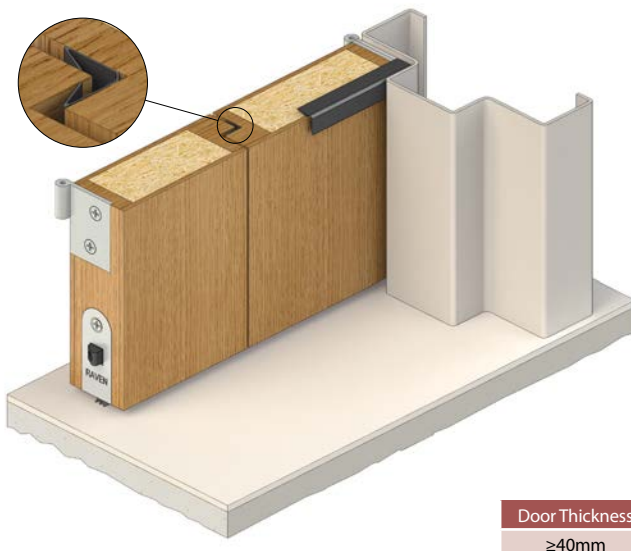

### RP130Si RP129F RP130Si

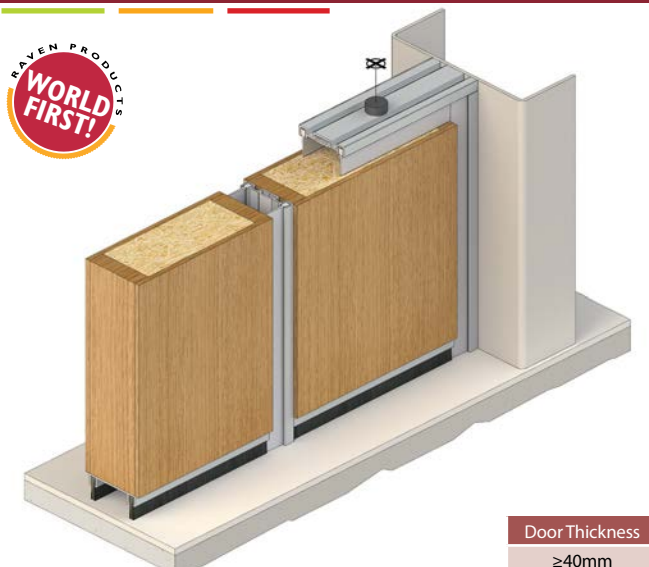

# Smoke Door Sealing Systems

Fire Engineered - Alternative Solutions



These systems may be used where the source of exposure could be from either side of the door opening and can be used where a fire engineered solution may be required. Effective combinations of smoke and acoustic seals tested on solid core doors that meet the requirements for AUS NCC specification C3.4 Deemed-to-Satisfy for smoke doors, UK Approved Document B and NZ Building Code Compliance Document C/AS1 Pt. 6.19.2 (b). Tested to AS 1530.7 and EN 1634-3. All systems open towards positive pressure (fire side).

## Smoke Leakage Rates

AS1530.7  $\leq 25\text{m}^3/\text{h}$  @ 25 Pa for single doors and  $\leq 40\text{m}^3/\text{h}$  @ 25 Pa for double doors when exposed to 200°C for 30 minutes in accordance with AS6905.

EN1634-3 Sa;  $\leq 3\text{m}^3/\text{h}/\text{m}$  @ 25 Pa excluding the threshold for ambient. For Sm;  $\leq 20\text{m}^3/\text{h}$  @ 50 Pa for single doors and  $\leq 30\text{m}^3/\text{h}$  @ ambient and 200°C in accordance with BS EN 13501-2

Test	Exposure	Leakage rate correction	Leakage rate Q (m <sup>3</sup> /h) at a pressure differential of;		
			10 Pa	25 Pa	50 Pa
01	Ambient	*SRC	7.8	13.2	19.3
	Medium 200°C	*SRC	4.4	8.1	15.6
	Medium 200°C > 30 min	*SRC	5.4	10.9	18.3
02	Ambient	*SRC	2.5	4.4	6.8
	Medium 200°C	*SRC	< 2.0	< 2.0	4.2
	Medium 200°C > 30 min	*SRC	4.7	12.6	10.2
03	Ambient	*SRC	0.6	1.2	1.9
	Medium 200°C	*SRC	< 2.0	< 2.0	2.6
	Medium 200°C > 30 min	*SRC	5.1	12.0	19.7
04	Ambient	*SRC	8.0	13.6	20.0
	Medium 200°C	*SRC	4.1	9.9	13.1
	Medium 200°C > 30 min	*SRC	4.6	9.7	13.5

\*Standard Reference Conditions

## RP76Si RP8Si

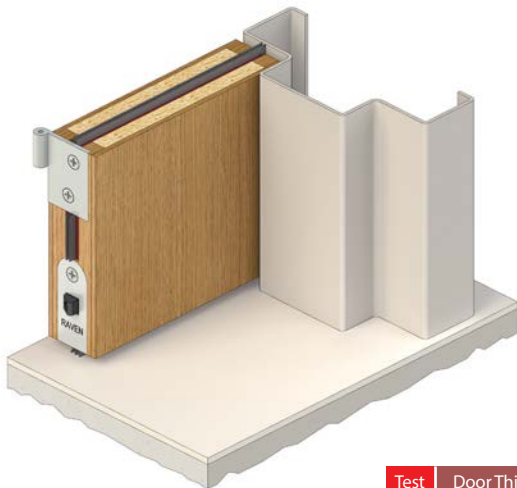

Test	Door Thickness
01	$\geq 35\text{mm}$

## RP120 RP8Si



Test	Door Thickness
02	$\geq 35\text{mm}$

## RP124 RP35Si

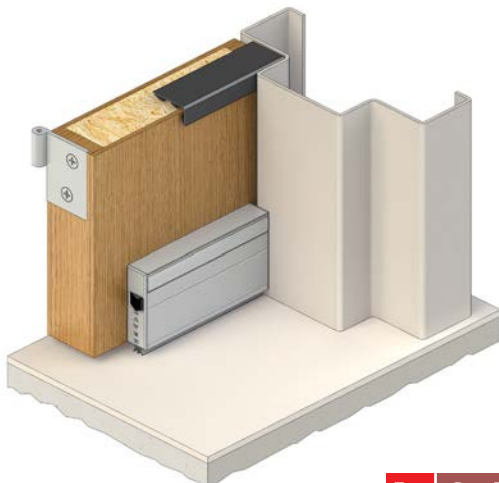

Test	Door Thickness
03	$\geq 35\text{mm}$

## RP670 RP8Si



Test	Door Thickness
04	$\geq 35\text{mm}$

# Smoke Door Sealing Systems

## Fire Engineered - Alternative Solutions



Test	Exposure	Leakage rate correction	Leakage rate Q (m³/h) at a pressure differential of;		
			10 Pa	25 Pa	50 Pa
05	Ambient	*SRC	4.9	8.9	13.5
	Medium 200°C	*SRC	<2.0	3.1	5.2
	Medium 200°C > 30 min	*SRC	<2.0	2.3	3.7
06	Ambient	*SRC	3.3	6.2	9.3
	Medium 200°C	*SRC	<2.0	3.5	4.7
	Medium 200°C > 30 min	*SRC	<2.0	5.1	9.5
07	Ambient	*SRC	3.5	6.2	9.5
	Medium 200°C	*SRC	2.9	3.5	8.2
	Medium 200°C > 30 min	*SRC	4.6	7.9	11.5
08	Ambient	*SRC	5.8	9.8	15.1
	Medium 200°C	*SRC	3.0	5.1	12.2
	Medium 200°C > 30 min	*SRC	3.3	5.8	11.4
09	Ambient	*SRC	3.5	8.1	14.2
	Medium 200°C	*SRC	3.3	7.9	11.2
	Medium 200°C > 30 min	*SRC	6.6	12.2	18.0

\*Standard Reference Conditions

### RP78Si RP38Si RP16Si

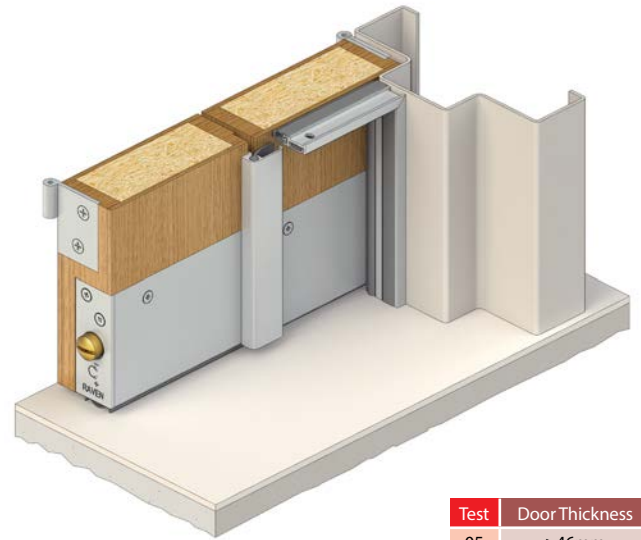

Test	Door Thickness
05	≥46mm

### RP124 RP8Si RP16Si

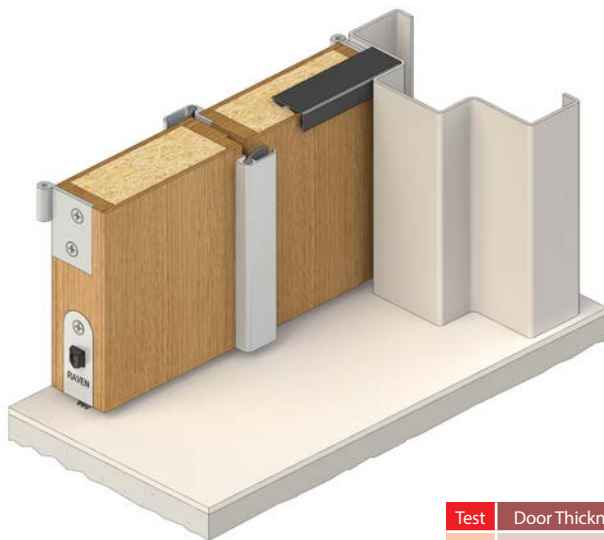

Test	Door Thickness
06	≥40mm

### RP150 RP126Si RP150

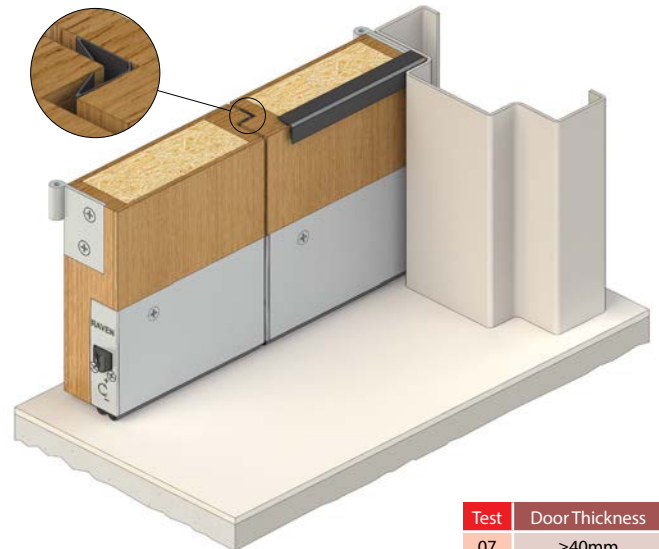

Test	Door Thickness
07	≥40mm

### RP130Si RP129F RP130Si

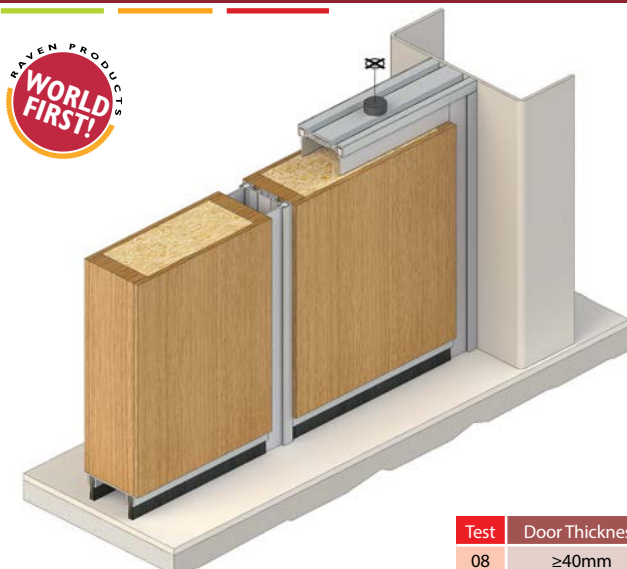

Test	Door Thickness
08	≥40mm

### RP130Si RP129Si RP130Si RP115

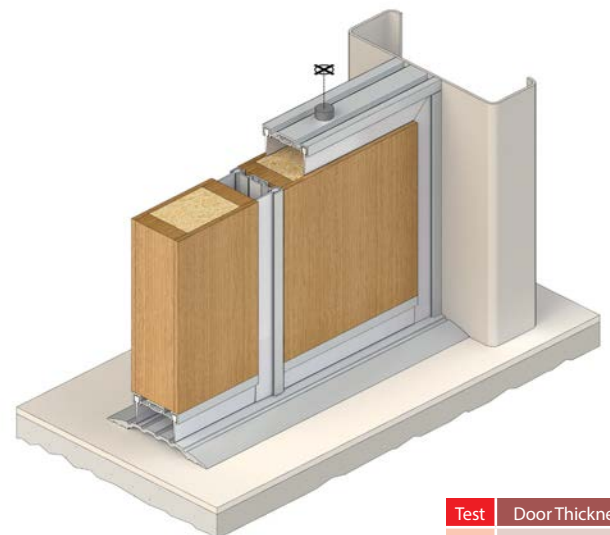

Test	Door Thickness
09	≥40mm

# Smoke Sealing Systems

## Fire Rated (Labelled) Doors



Effective combinations of smoke and acoustic seals for fire rated butt hinged doors. These seals have been tested and/or assessed to AS 1530.4 and BS 476 Pt. 22, similar to BS EN 1634-1. Seals conform to the AUS NCC specification C3.4 Deemed-to-Satisfy for smoke doors 200°C for 30 minutes, NZ BC Compliance Doc. C, UK Approved Document B and Standard BS 5588. All door seals shown have been tested to AS 1530.7 and EN 1634-3.

A large range of product combinations may be used, refer to door bottom seals and door frame or perimeter seals sections for fire ratings of individual seals [page 42 - 107](#).

Fire doors in Australia need to be installed to AS1905.1 as mandated by the NCC. This means the fire door has a Fire Resistance Level (FRL) as determined in the fire test method AS 1530.4 where door sets are subject to extreme temperatures in a full scale fire test simulating a fire emergency. The door set is then given an FRL which is a nominal grading period in minutes for structural adequacy/integrity/insulation. Fire doors are not structural members of a building so therefore have for example an FRL of -/120/60 where the FRL is 0 for structural adequacy/120 minutes for integrity/60 minutes for insulation. This is represented in NZ as FRR -/120/60 or in the UK for integrity as FD60 or in Europe IE60.

Door hardware including door seals are then tested to evaluate there is no reduction in the established FRL of that fire door.

### RP10Si RP8Si

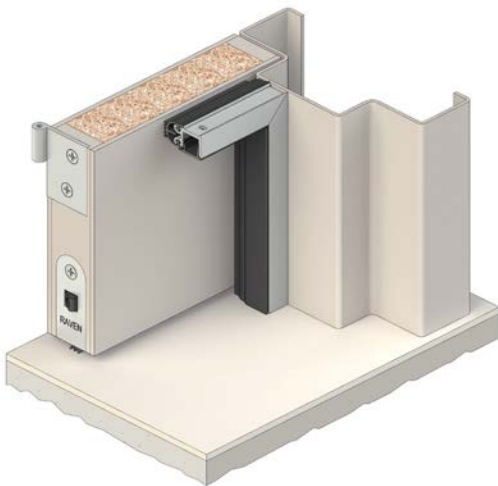

### RP24Si RP38Si



Perimeter seal adjustment independent of fixings

### RP78Si RP8Si



### RP78Si RP35Si

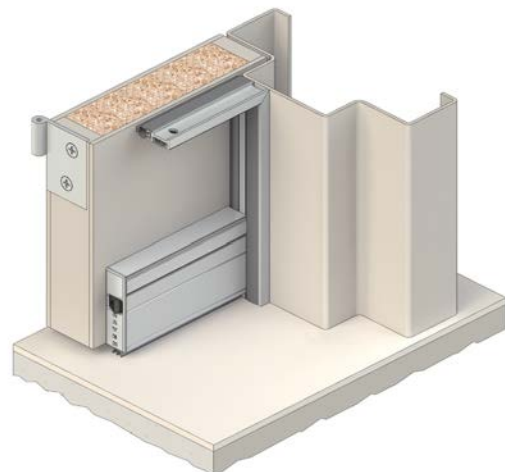

# Smoke Sealing Systems

## Fire Rated (Labelled) Doors



**RP78Si RP38Si**

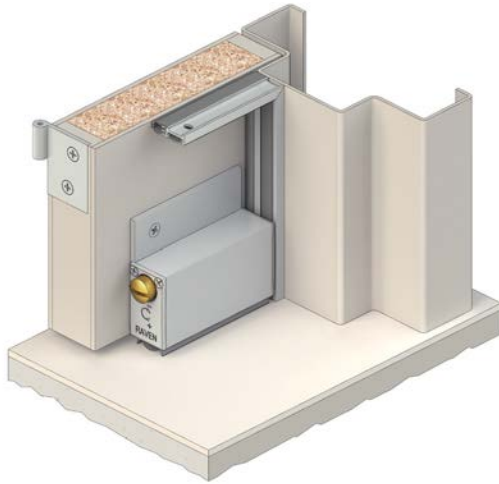

**RP78Si RP127Si**

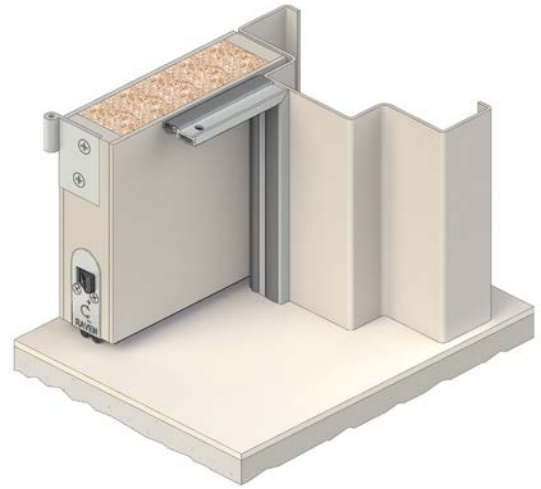

**RP87Si RP128Si**

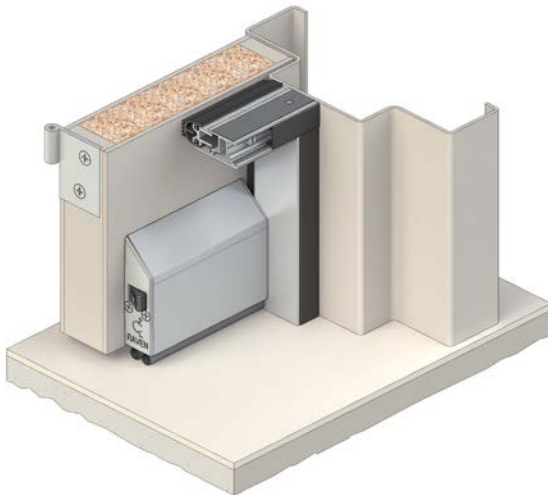

**RP93Si RP99Si**

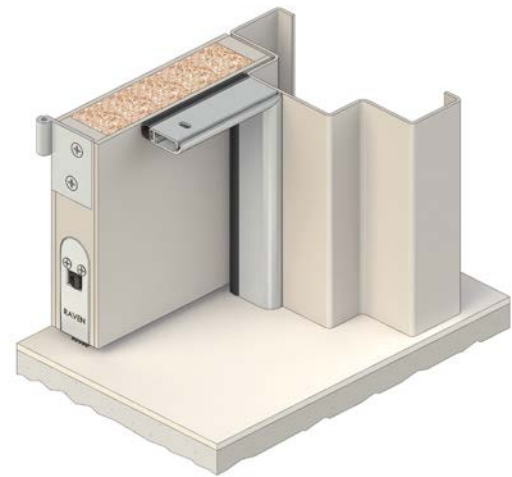

Perimeter seal adjustment independent of fixings

**RP94Si RP126Si**

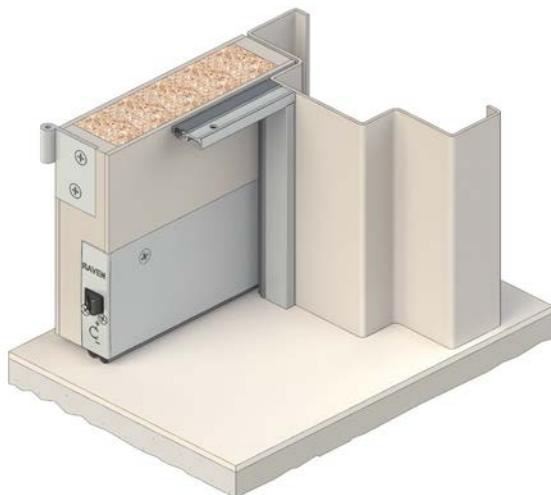

**RP120 / RP150 / RP124 RP8Si**



# Bushfire - Sealing Systems

## Bushfire Prone Areas - Ember Attack



Due to bushfires in Canberra in 2003 and the tragedy of the Victorian bushfires in 2009, the Australian Standard "Construction of Buildings in Bushfire Prone Areas" AS 3959 was revised. The changes provide better guidance to the construction of buildings to AS 3959 with the purpose of providing greater ability to withstand a bushfire attack. Bushfire Attack Levels (BAL) were defined and means to assessing a building site to these levels. Construction requirements are now laid out to define the requirements for different elements of a building to the BAL.

Throughout the catalogue BAL icons are used to show what Bushfire Attack Level the product is suitable for. Shown here are a range of sealing systems that may be used in accordance with AS 3959 to meet these requirements.

### RP78Si RP4FZ

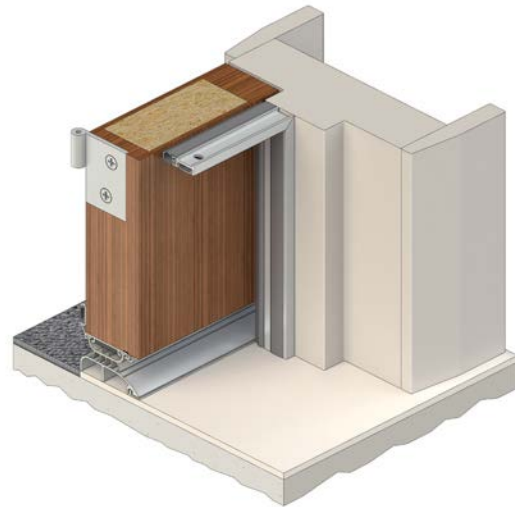

Butt Hinged Entry Doors

### RP78Si RP51Si RP16Si RP82



Double Outward Opening Doors

### RP600 RP51Si

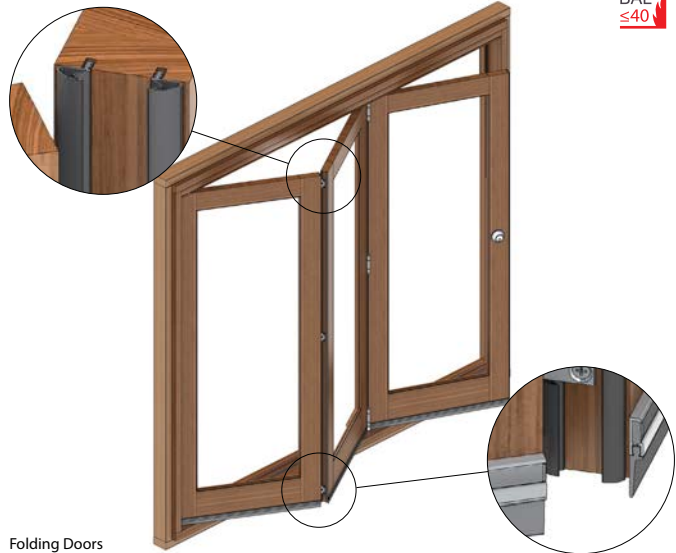

Folding Doors

### RP41 RP75 RP114 RP91

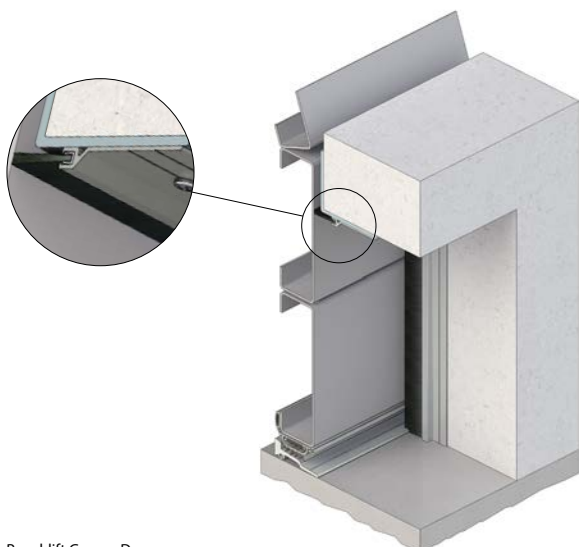

Panel-lift Garage Doors

### RP75 RP75

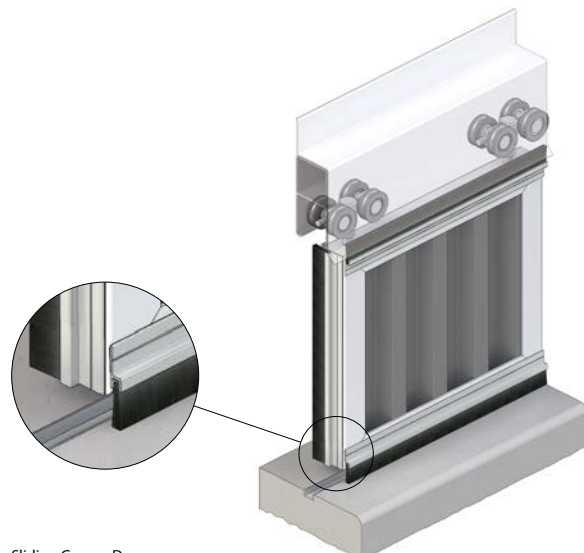

Sliding Garage Doors





# Bushfire - Sealing Systems

## Bushfire Prone Areas - Ember Attack



The table below can assist product selection in meeting the design requirements of the latest Australian Bushfire Standard AS 3959. Raven seals being multi-purpose can be used for all new and retrofit work.

Product selection should be made when assessing the mandated requirements listed in the AUS NCC and the Australian Bushfire Standard AS 3959. Specifiers will determine the suitability of the information provided when selecting a Raven seal for their purposes.

Australian Bushfire Standard AS 3959 BAL (Bushfire Attack Level)	Side Hung (Ember Attack) Raven Perimeter Seal and Door Bottom Seal	Garage Doors (Ember Attack) Roller and Sectional Overhead
<b>BAL - LOW</b>  <i>Note: There is no further requirement from AS 3959.</i>	All Raven Seals that display the BAL Low icon.  	Raven nylon brush strip seal RP2a, RP2b, RP41, RP49, RP50, RP51F, RP57, RP58, RP74, RP74F, RP75 at door head and sides where required.  Door bottom seal RP4T or RP51Si (if bottom seal not supplied with door)  Option: Threshold plate RP91 <span style="float: right;">Refer to <a href="#">page 12</a></span>
<b>BAL - 12.5, 19, 29</b>	All Raven Seals that display the BAL ≤ 29 icon.  	Raven nylon brush strip seal RP2a, RP2b, RP41, RP49, RP50, RP51F, RP57, RP58, RP74, RP74F, RP75 at door head and sides where required.  Door bottom seal RP4T or RP51Si (if bottom seal not supplied with door)  Option: Threshold plate RP91 <span style="float: right;">Refer to <a href="#">page 12</a></span>
<b>BAL - 40</b>	All Raven Seals that display the BAL ≤ 40 icon.  	Raven nylon brush strip seal RP2a, RP2b, RP41, RP49, RP50, RP51F, RP74, RP74F, RP75 at door head and sides where required.  Door bottom seal RP4T (if bottom seal not supplied with door)  Threshold plate RP91 <span style="float: right;">Refer to <a href="#">page 12</a></span>
<b>BAL - FZ</b>	All Raven Seals that display the BAL FZ icon.  	Raven nylon brush strip seal RP2a, RP2b, RP41, RP49, RP50, RP74, RP74F, RP75 at door head and sides where required.  Door bottom seal RP4T (if bottom seal not supplied with door)  Threshold plate RP91 <span style="float: right;">Refer to <a href="#">page 12</a></span>





## Noise - Acoustic

*NCC Class 2 - Class 9 Buildings (high rise apartments, hospitals, hotels, schools, theatres, conference rooms and offices)*

Reducing the amount of sound that passes through a door set is a common application for Raven door seals. Sealing door gaps is of prime importance when helping to reduce the amount of sound entering or leaving a room or building. Unlike air, where the amount flowing through a gap changes in proportion to the gap size, sound waves move through these gaps with little loss. Consequently, small gaps around a doorway can let through nearly as much sound as an open door. Because of this, any small clearances not sealed can reduce the effectiveness of a solid core door or acoustically engineered door or partition.

Raven acoustic seals provide an excellent barrier to airborne sound and help ensure that the acoustic attenuation provided by an acoustically sealed door assembly can in many cases be equivalent to the wall or partition into which it is installed.

Raven acoustic seals help isolate buildings from external noise, such as the noise generated from roads, railways and airports. They also help isolate rooms from airborne noise generated within a building. For example; plant and machinery, theatres, cinemas, crèches, dental and doctors' surgeries, stairwells, passages, interconnecting hotel rooms and adjoining apartments.





In Australia, the NCC Sect. F5.5 and Sect. F2.4.6 mandates that Class 2 buildings; typically apartments, multi-residential and Class 3 buildings; hotels, motels and age care buildings etc., must have entry doors with a minimum sound insulation rating of Rw30. The UK Building Approved Document E states a minimum Rw29 is required.

Raven acoustic seals are used in airports, hotels, offices, hospitals, homes and anywhere noise infiltration occurs through doors. Their effectiveness is best illustrated by the repeated use of Raven seals by architects, acoustic engineers, door fabricators, and project builders.

Raven, the industry leader in door sealing systems, pioneered baseline acoustic testing, utilising "off the shelf" doors and ironmongery to give specifiers proven, cost effective solutions to the growing problem of noise in living and workplace environments.

Acoustic door manufacturers increasingly incorporate Raven door sealing systems with acoustically engineered doors to achieve and maintain the highest Rw ratings up to Rw52 (STC 52).

Refer to [page 40](#) and [41](#).

### Improving Rw (STC) Ratings

It should be considered, that the Rw (STC) rating of a door set is only as good as the sum of its parts. i.e. the Rw value of the door and frame fitted with Raven acoustic seals, the wall, the ceiling and floor surface.

The use of soft absorbent furnishings within a room will also help absorb unwanted noise. All these measures will improve the acoustic attenuation of the room and increase the aggregate Rw value of the construction.

Typically, when Raven acoustic seals are fitted to timber solid core doors the Rw rating of the door assembly is increased from around Rw16 up to Rw32. When the assembly is placed into an Rw55 wall, the overall rating of the door assembly and wall combination drops slightly as a ratio to area. The larger the wall area the less the combined Rw rating will drop.



## AUS National Construction Code (NCC) Part F5

### Class 2 - Class 9 buildings

#### F5.5 Sound insulation rating of walls

(a) A wall in a Class 2 or 3 building must—

- (i) have an  $R_w + C_{tr}$  (airborne) not less than 50, if it separates *sole-occupancy units*; and
- (ii) have an  $R_w$  (airborne) not less than 50, if it separates a *sole-occupancy unit* from a plant room, lift *shaft*, stairway, *public corridor*, public lobby or the like, or parts of a different classification; and
- (iii) comply with **F5.3(b)** if it separates—

(A) a bathroom, *sanitary compartment*, laundry or kitchen in one *sole-occupancy unit* from a *habitable room* (other than a kitchen) in an adjoining unit; or

(B) a *sole-occupancy unit* from a plant room or lift *shaft*.

**(b) A door may be incorporated in a wall in a Class 2 or 3 building that separates a sole-occupancy unit from a stairway, public corridor, public lobby or the like, provided the door assembly has an  $R_w$  not less than 30.**

### Acoustic Standards, Test Methods and Ratings

Test methods used to establish the noise attenuation ability of a door set are AS1191, ISO 140 series, and more recently EN ISO 10140 series standards. Test data from any one of these test methods can be used in EN ISO 717.1 which provides a single number rating across a spectra of frequencies for the noise attenuation ability of the building element. Typically Rw is used for door sets which covers the frequencies of 100Hz to 3.125 kHz.

### Related Building Codes

There are several standards, which refer to seal properties and testing for weather - energy:

#### AUS / NZ

Requirements are noted in the Australian National Construction Code (NCC) and New Zealand NZ BC Compliance Doc. H.

#### UK / EU

Requirements are noted in the British Building Regulations Approved Document E.

#### USA

Requirements are noted in the Building Code and the Residential Code IBC 2000.

For further details, refer to Standards / Authorities on page 114.



### Performance Testing

Raven acoustic sealing systems are regularly tested in accordance with AS 1191 (EN ISO 140.3), EN ISO 10140 series and rated to EN ISO 717.1 by recognised testing authorities and specialised acoustic laboratories.

The tabulated results are presented as the Sound Transmission Loss (STL) in the frequencies of 100Hz - 5000Hz. This is the measured sound pressure loss in decibels of the door set and seal combination at the tested frequency. The Sound Transmission Class (STC) and the Weighted Sound Reduction Index (Rw) are single number ratings of a material's or an assembly's ability to resist airborne sound transfer at the frequencies of 125Hz - 4000Hz and 100Hz - 3150Hz respectively.

Higher acoustic values of up to STC 52 have been certified by using higher density, acoustically designed doors in conjunction with Raven acoustic sealing systems.



RP10 / RP10Si RP8Si

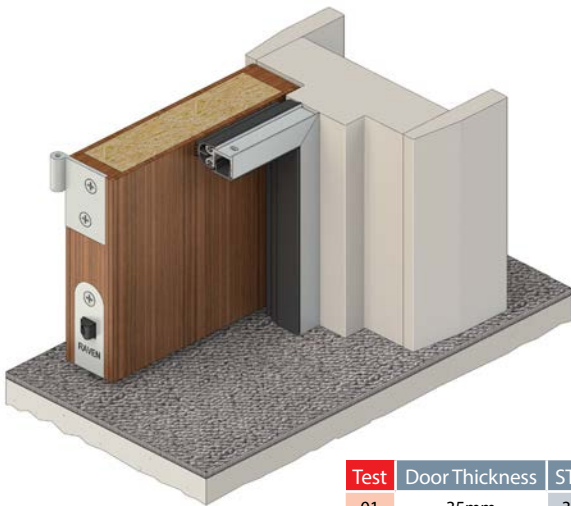

Test	Door Thickness	STC	Rw
01	35mm	30	30
11	44mm	32	32

RP10 / RP10Si RP99Si

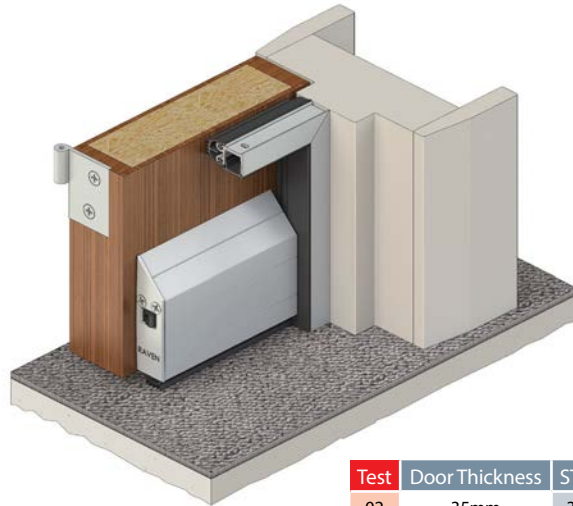

Test	Door Thickness	STC	Rw
02	35mm	30	30
12	44mm	32	32

RP10 / RP10Si RP99Si

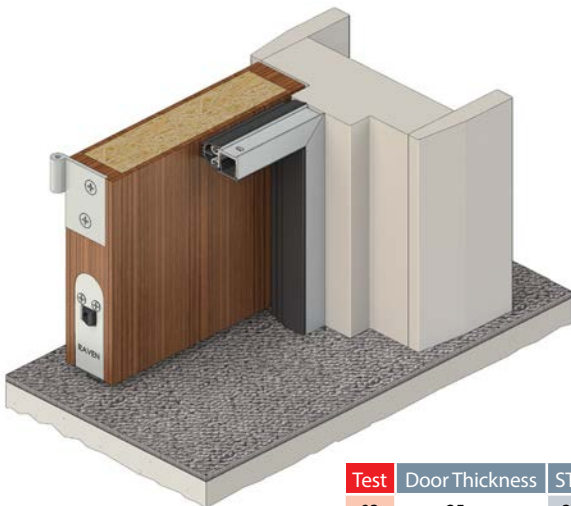

Test	Door Thickness	STC	Rw
03	35mm	30	30
13	44mm	33	32

RP10 / RP10Si RP99Si

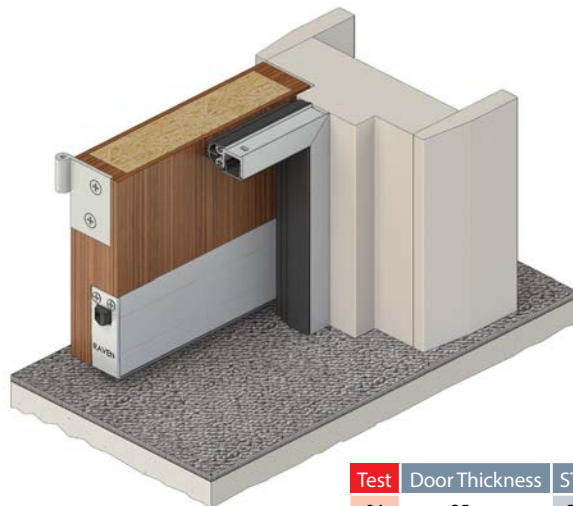

Test	Door Thickness	STC	Rw
04	35mm	30	30
14	44mm	32	32



### RP24 RP38

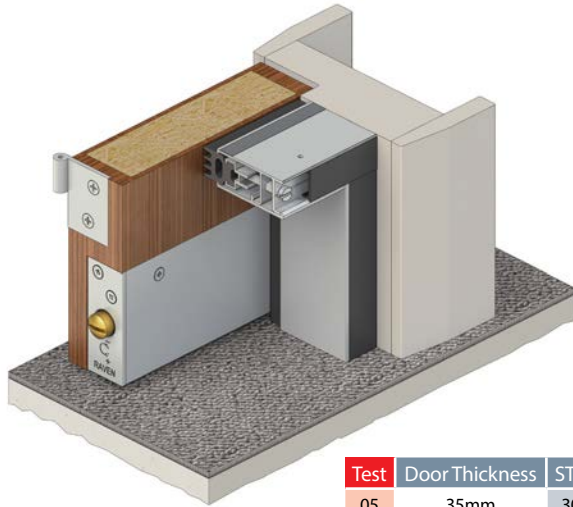

Test	Door Thickness	STC	Rw
05	35mm	30	30
15	44mm	33	32

Perimeter seal adjustment independent of fixings

### RP24 RP70

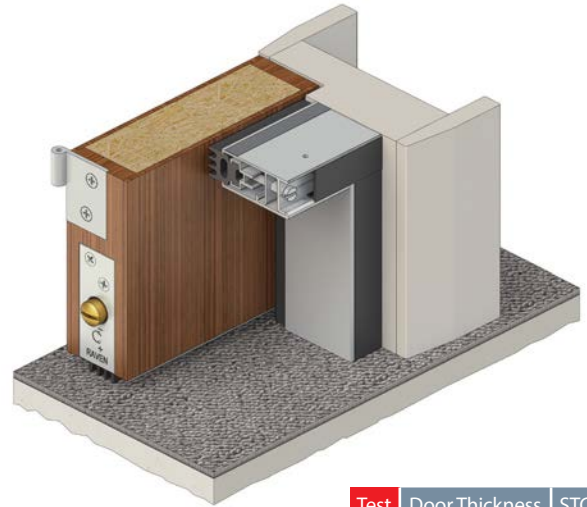

Test	Door Thickness	STC	Rw
16	44mm	31	32

Perimeter seal adjustment independent of fixings

### RP47Si RP38

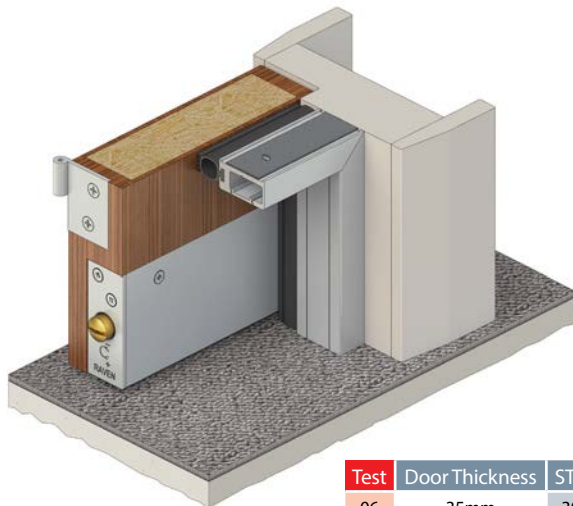

Test	Door Thickness	STC	Rw
06	35mm	30	30
17	44mm	32	32

### RP47Si RP70



Test	Door Thickness	STC	Rw
18	44mm	32	32

### RP78Si RP8Si

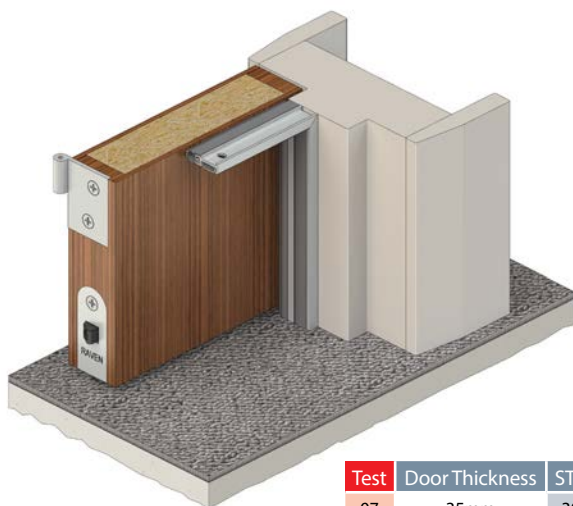

Test	Door Thickness	STC	Rw
07	35mm	30	30
19	44mm	32	32

### RP84Si RP8Si

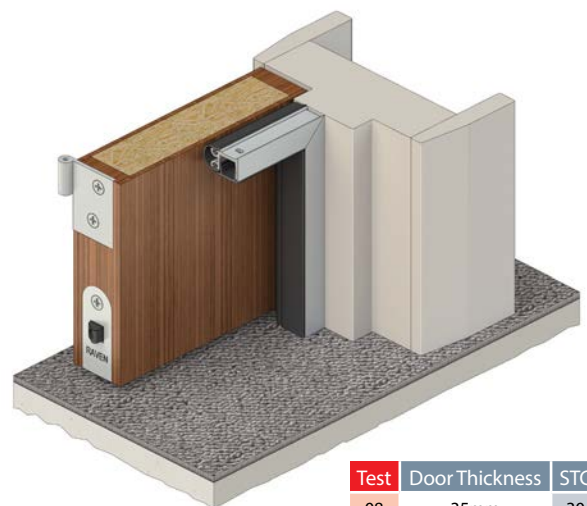

Test	Door Thickness	STC	Rw
08	35mm	30	30
20	44mm	32	32



### RP93Si RP99Si

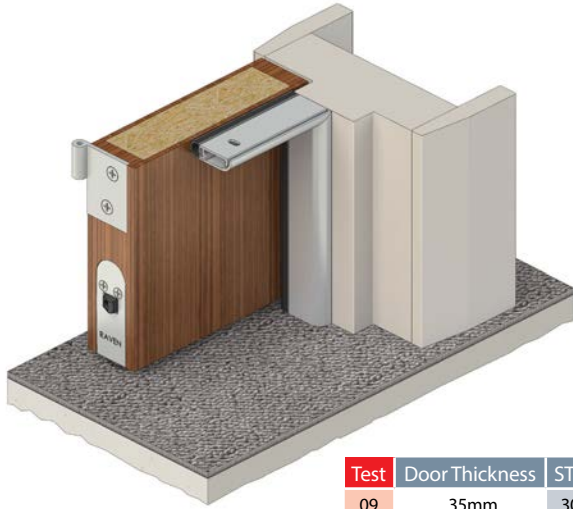

Test	Door Thickness	STC	Rw
09	35mm	30	30
21	44mm	32	32

### RP94Si RP8Si

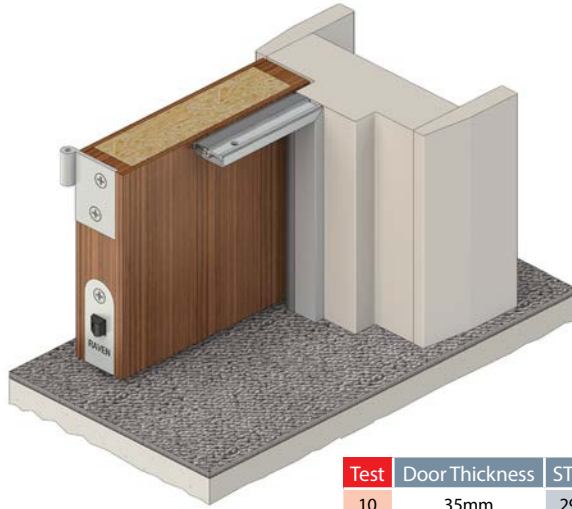

Test	Door Thickness	STC	Rw
10	35mm	29	29
22	44mm	30	30

### RP94Si RP99Si



Test	Door Thickness	STC	Rw
23	44mm	30	30

### RP120 RP8Si

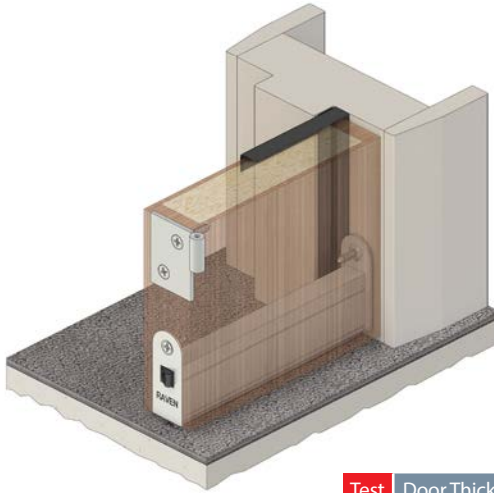

Test	Door Thickness	STC	Rw
24	44mm	31	31

### RP150 RP8Si

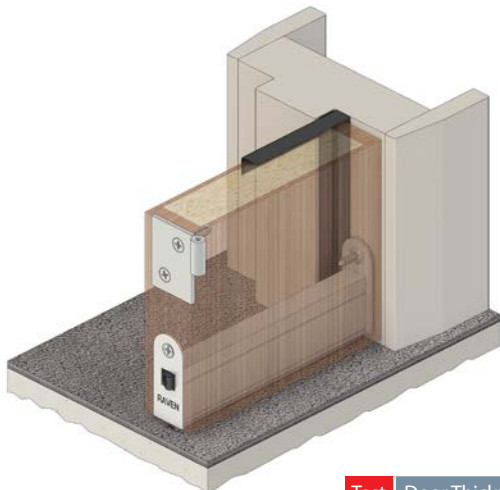

Test	Door Thickness	STC	Rw
25	44mm	32	32



RP94Si RP8Si



Test	Door Thickness	STC	Rw
26	40mm	38	38

RP10 / RP10Si RP99Si RP16Si

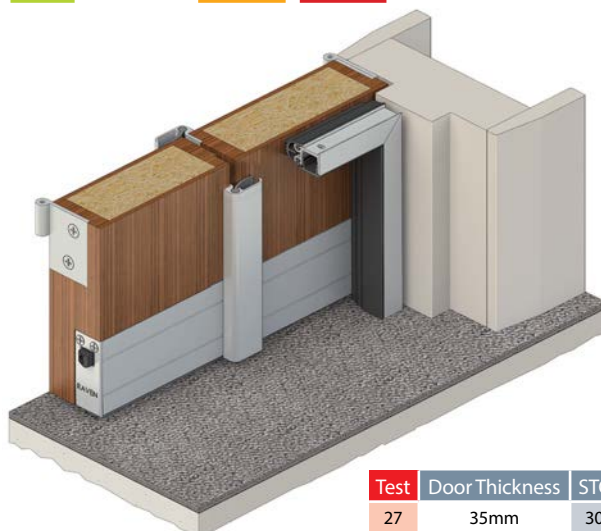

Test	Door Thickness	STC	Rw
27	35mm	30	30
31	44mm	32	32

RP10 / RP10Si RP99Si RP71

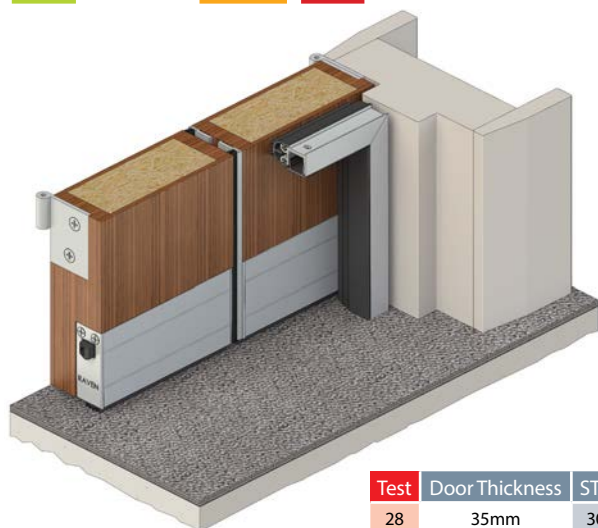

Test	Door Thickness	STC	Rw
28	35mm	30	30
32	44mm	32	32

RP10 / RP10Si RP99Si RP71Si



Test	Door Thickness	STC	Rw
29	35mm	30	30
33	44mm	32	32

RP10 / RP10Si RP99Si RP85

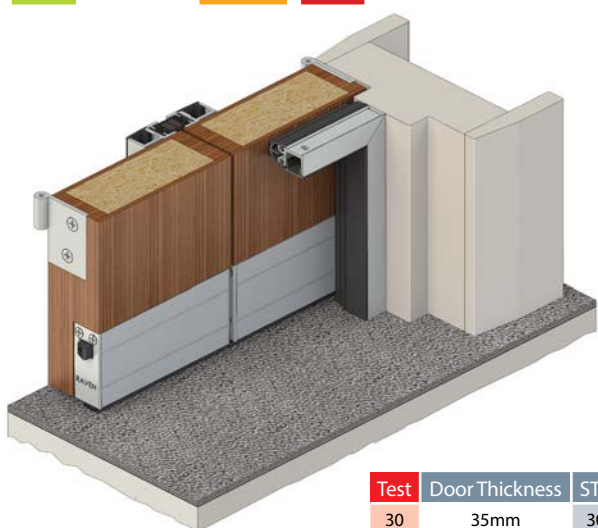

Test	Door Thickness	STC	Rw
30	35mm	30	30
34	44mm	32	32

RP10Si RP128Si RP71Si



Test	Door Thickness	STC	Rw
35	45mm	30	30



### RP24 RP38 RP71Si

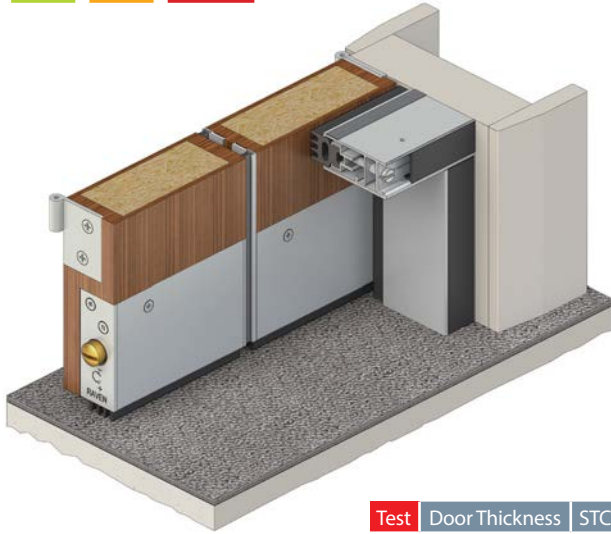

Test	Door Thickness	STC	Rw
36	45mm	30	30

Perimeter seal adjustment independent of fixings

### RP24Si RP38Si RP16Si

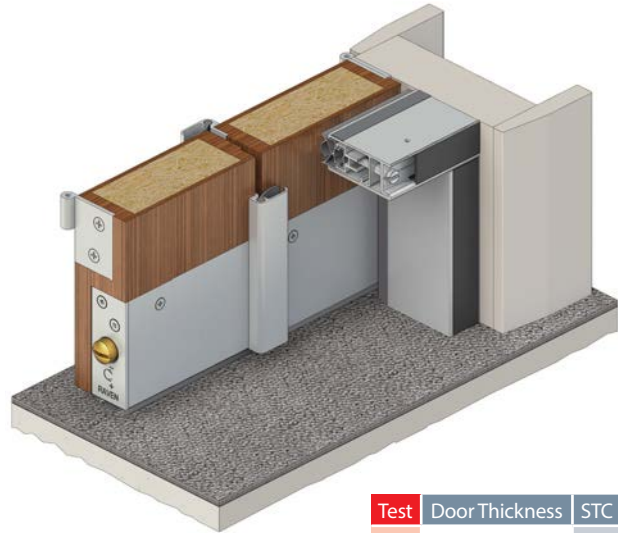

Test	Door Thickness	STC	Rw
37	45mm	30	30

Perimeter seal adjustment independent of fixings

### RP84Si RP126Si RP16Si

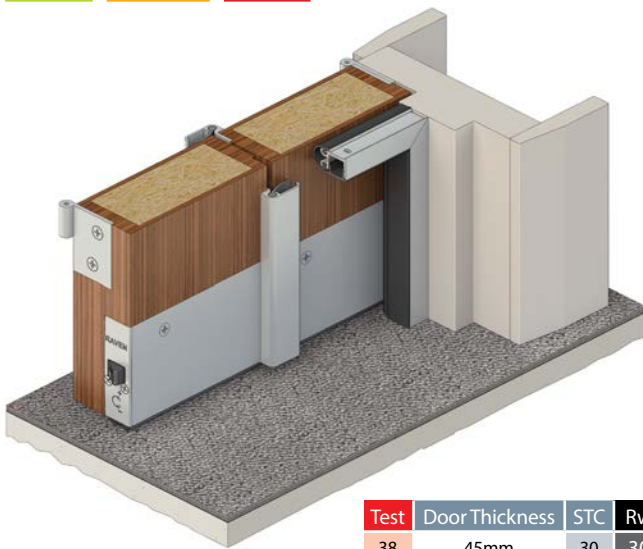

Test	Door Thickness	STC	Rw
38	45mm	30	30

### RP84Si RP127Si RP71Si



Test	Door Thickness	STC	Rw
39	45mm	31	31

### RP84Si RP128Si RP71Si



Test	Door Thickness	STC	Rw
40	45mm	30	30

### RP87HSi RP127Si RP71Si



Test	Door Thickness	STC	Rw
41	45mm	30	30

Perimeter seal adjustment independent of fixings



## Test Performance Data

Test	Raven Door Seals	Frequency (Hertz) vs STL (dB)																			
		STC	Rw	100	125	160	200	250	315	400	500	630	800	1000	1250	1600	2000	2500	3150	4000	5000
<b>Single Doors</b>																					
<b>35mm Solid Core Doors</b>																					
	*FULLY CAULKED DOOR	30	30	20.7	21.0	20.7	26.8	22.2	26.7	24.4	25.3	27.9	28.5	28.9	30.2	32.3	34.4	35.5	37.2	37.6	37.6
01	RP10 / RP10Si RP8Si	30	30	20.7	21.0	20.7	26.5	22.2	26.7	24.4	25.3	27.3	28.4	27.9	28.6	30.8	33.6	35.5	35.2	34.8	35.1
02	RP10 / RP10Si RP99Si	30	30	20.7	21.0	20.4	26.8	22.2	26.7	24.4	25.3	27.9	28.3	28.9	30.2	31.9	34.1	35.5	37.2	37.6	37.3
03	RP10 / RP10Si RP99Si	30	30	20.7	21.0	20.4	26.8	22.2	26.7	24.4	25.3	27.9	28.3	28.9	30.2	32.3	34.4	35.5	37.2	37.3	36.9
04	RP10 / RP10Si RP99Si	30	30	20.4	21.0	20.6	26.7	22.2	26.7	24.4	25.3	27.9	28.4	28.9	30.0	31.9	34.3	35.5	37.2	37.3	36.9
05	RP24 RP38	30	30	20.7	21.0	20.2	26.7	22.2	26.6	24.4	25.3	27.9	28.4	28.8	30.2	32.3	34.4	35.5	37.0	36.8	37.4
06	RP47Si RP38	30	30	20.6	21.0	20.4	26.6	22.2	26.3	24.3	25.3	27.9	28.4	28.8	30.2	32.3	34.4	35.5	36.5	37.0	37.3
07	RP78Si RP8Si	30	30	20.7	21.0	20.4	26.8	22.2	26.3	24.4	25.3	27.0	28.4	28.7	29.5	31.1	32.5	34.1	35.1	35.9	35.7
08	RP84Si RP8Si	30	30	20.7	21.0	20.7	26.5	22.2	26.7	24.4	25.3	27.3	28.4	27.9	28.6	30.8	33.6	35.5	35.2	34.8	35.1
09	RP93Si RP99Si	30	30	20.6	21.0	20.6	26.8	22.2	26.7	24.4	25.0	27.5	28.4	28.9	30.2	32.3	34.3	35.5	37.2	37.6	37.5
10	RP94Si RP8Si	29	29	20.5	20.7	20.6	26.6	22.2	26.2	24.2	24.7	25.6	28.3	27.6	28.0	29.6	30.6	33.1	34.5	34.3	34.3
<b>44mm Solid Core Doors</b>																					
	*FULLY CAULKED DOOR	33	33	21.6	20.6	23.9	26.0	25.2	27.5	29.2	30.1	29.7	30.6	31.1	31.9	33.7	35.7	36.8	38.0	38.9	38.5
11	RP10 / RP10Si RP8Si	32	32	21.6	20.6	23.8	25.8	25.2	27.4	29.1	30.1	28.9	30.5	29.5	29.7	31.7	34.6	36.8	35.6	35.5	35.5
12	RP10 / RP10Si RP99Si	32	32	21.6	20.6	23.3	26.0	25.2	27.5	29.1	30.1	29.6	30.5	31.0	31.8	33.2	35.5	36.8	38.0	38.9	38.1
13	RP10 / RP10Si RP99Si	33	32	21.6	20.6	23.3	26.0	25.2	27.4	29.2	30.1	29.6	30.2	31.0	31.8	33.7	35.7	36.8	38.0	38.5	37.6
14	RP10 / RP10Si RP99Si	32	32	21.2	20.6	23.7	26.0	25.1	27.4	29.0	29.9	29.6	30.5	31.0	31.6	33.2	35.5	36.8	38.0	38.5	37.6
15	RP24 RP38	33	32	21.6	20.6	22.9	26.0	25.2	27.4	29.2	30.0	29.6	30.5	31.0	31.8	33.7	35.7	36.8	37.7	37.8	38.3
16	RP24 RP70	31	32	20.7	21.0	20.4	26.8	22.2	26.3	24.3	25.2	27.9	28.4	28.8	30.0	31.2	33.1	33.8	31.8	29.6	32.1
17	RP47Si RP38	32	32	21.6	20.6	23.2	25.9	25.2	27.0	29.0	30.0	29.6	30.5	31.0	31.8	33.7	35.7	36.5	37.2	38.1	38.1
18	RP47Si RP70	32	32	21.6	20.6	22.9	25.9	25.1	26.4	28.3	29.5	29.4	30.5	31.0	31.8	31.8	33.1	34.6	35.9	36.9	32.2
19	RP78Si RP8Si	32	32	21.6	20.6	23.3	26.0	25.2	27.1	29.1	29.9	28.3	30.5	30.8	30.9	32.1	33.2	35.0	35.6	36.7	36.2
20	RP84Si RP8Si	32	32	21.6	20.6	23.8	25.8	25.2	27.4	29.1	30.1	28.9	30.5	29.5	29.7	31.7	34.6	36.8	35.6	35.5	35.5
21	RP93Si RP99Si	32	32	21.5	20.6	23.7	26.0	25.2	27.5	29.0	29.2	29.1	30.5	31.0	31.8	33.7	35.5	36.8	38.0	38.9	38.4
22	RP94Si RP8Si	30	30	21.3	20.4	23.7	25.9	25.1	27.0	28.6	28.3	26.5	30.2	29.2	28.9	30.3	31.1	33.8	35.0	34.8	34.7
23	RP94Si RP99Si	30	30	21.3	20.5	22.6	25.9	24.6	25.8	28.1	28.8	28.6	30.2	30.4	29.0	27.5	27.9	31.0	33.7	34.5	32.8
24	RP120 RP8Si	31	31	19.5	23.9	28.0	29.5	30.5	30.5	31.9	31.0	29.8	28.0	28.2	30.0	31.8	33.3	34.1	35.2	37.0	38.5
25	RP150 RP8Si	32	32	23.3	24.1	26.8	29.7	29.8	31.2	32.4	32.7	32.6	29.2	29.2	29.9	32.0	31.9	32.6	33.4	34.1	35.8
<b>Interconnecting Doors</b>																					
<b>40mm Solid Core Doors</b>																					
	NO DOOR SEALS	24	24	15.5	11.5	20.5	23.5	21.5	24.0	27.5	27.5	29.5	30.5	30.0	31.0	30.5	28.0	22.5	20.5	23.0	24.5
	*FULLY CAULKED DOOR	40	40	19.5	21.5	27.5	33.0	34.0	34.5	36.5	36.5	36.5	39.0	41.0	N/A	43.0	42.5	42.5	42.0	40.5	39.0
26	RP94Si RP8Si	38	38	25.5	22.0	28.5	35.5	34.0	37.5	40.5	35.0	34.5	36.0	38.0	N/A	37.0	39.5	41.0	41.5	41.0	39.5
<b>Pairs of Doors</b>																					
<b>35mm Solid Core Doors</b>																					
	*FULLY CAULKED DOOR	30	30	20.7	21.0	20.7	26.8	22.2	26.7	24.4	25.3	27.9	28.5	28.9	30.2	32.3	34.4	35.5	37.2	37.6	37.6
27	RP10 / RP10Si RP99Si RP16Si	30	30	20.5	20.8	20.7	26.7	22.0	26.6	24.3	25.3	29.9	28.5	28.8	30.1	31.8	34.1	35.3	36.8	36.9	36.8
28	RP10 / RP10Si RP99Si RP71	30	30	20.6	20.8	20.7	26.8	22.1	26.7	24.3	25.2	27.8	28.5	28.6	30.1	32.1	34.3	35.4	37.1	37.4	37.4
29	RP10 / RP10Si RP99Si RP71Si	30	30	20.7	20.9	20.7	26.7	22.1	26.6	24.3	25.3	27.8	28.3	28.3	29.9	31.6	34.1	35.3	36.8	37.1	36.9
30	RP10 / RP10Si RP99Si RP85	30	30	20.3	20.9	20.7	26.7	22.0	26.6	24.3	25.2	27.6	28.3	28.6	30.1	31.6	33.8	35.0	37.0	36.9	36.6
<b>44mm Solid Core Doors</b>																					
	*FULLY CAULKED DOOR	33	33	21.6	20.6	23.9	26.0	25.2	27.5	29.2	30.1	29.7	30.6	31.1	31.9	33.7	35.7	36.8	38.0	38.9	38.5
31	RP10 / RP10Si RP99Si RP16Si	32	32	21.3	20.4	23.9	26.0	24.8	27.4	29.0	29.9	29.7	30.5	30.9	31.7	33.0	35.3	36.5	37.5	38.0	37.5
32	RP10 / RP10Si RP99Si RP71	32	32	21.5	20.4	23.9	26.0	24.9	27.5	29.0	29.7	29.5	30.5	30.6	31.7	33.4	35.5	36.7	37.9	38.7	38.2
33	RP10 / RP10Si RP99Si RP71Si	32	32	21.6	20.5	23.9	26.0	24.9	27.4	28.8	29.9	29.5	30.3	30.2	31.5	32.7	35.3	36.5	37.5	38.2	37.7
34	RP10 / RP10Si RP99Si RP85	32	32	21.1	20.5	23.9	25.9	24.8	27.4	29.0	29.7	29.2	30.3	30.6	31.7	32.7	35.0	36.2	37.8	38.0	37.3
<b>45mm Solid Core Doors</b>																					
	NO DOOR SEALS	21	22	13.9	16.8	19.3	18.8	21.3	20.2	19.9	21.2	21.2	22.0	23.5	23.7	22.7	21.5	21.6	19.2	17.6	17.2
	*FULLY CAULKED DOOR	31	31	25.1	27.8	29.9	30.4	31.6	30.7	29.5	30.1	27.0	26.3	27.8	30.0	32.5	35.2	37.4	39.6	41.1	40.6
35	RP10Si RP128Si RP71Si	30	30	21.0	25.3	29.0	29.8	31.5	30.2	30.2	30.8	27.5	26.5	28.1	28.7	29.5	30.0	32.7	32.6	34.2	35.6
36	RP24 RP38 RP71Si	30	30	20.7	25.0	28.3	27.3	29.7	27.9	27.5	28.2	26.0	25.3	27.8	29.1	31.5	33.8	34.9	34.6	35.5	36.1
37	RP24Si RP38Si RP16Si	30	30	19.5	23.8	26.9	27.0	28.8	27.7	26.4	26.7	25.9	25.6	27.7	30.0	31.3	32.6	33.4	33.4	35.2	35.3
38	RP84Si RP126Si RP16Si	30	30	20.6	24.7	28.2	29.2	30.9	29.7	28.8	30.4	28.1	27.4	28.7	28.5	29.4	31.4	32.8	31.7	33.6	35.6
39	RP84Si RP127Si RP71Si	31	31	21.6	26.3	30.7	29.7	31.3	30.5	29.8	30.6	27.4	26.1	27.9	29.1	30.2	32.9	35.0	35.8	37.2	37.6
40	RP84Si RP128Si RP71Si	30	30	22.3	26.7	28.4	29.7	31.8	30.3	29.7	30.7	27.7	26.3	28.3	28.3	29.0	30.1	32.6	33.2	34.7	36.5
41	RP87HSi RP127Si RP71Si	30	30	21.5	26.3	29.6	29.3	30.9	29.4	29.0	29.9	26.5	26.0	28.0	29.9	30.7	32.1	34.3	35.1	36.9	37.7

\* Theoretical maximum achievable.

# Noise - Acoustic - Sealing Systems



## Bulkhead

Bulkhead sealing is used in situations where a continuous, uninterrupted seal is required around all four edges of a door (or around the frame and across the sill), such as in plant rooms and emergency exit doors. In some cases this means the sill of the door may need to be suitably detailed so that the selected seal can be installed. *Note: Broad butt hinges should be specified.*



RP47Si

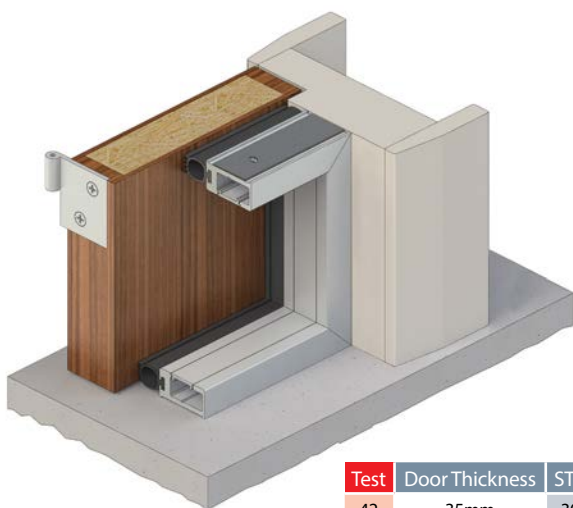

Test	Door Thickness	STC	Rw
42	35mm	30	30
43	44mm	32	32

RP118Si

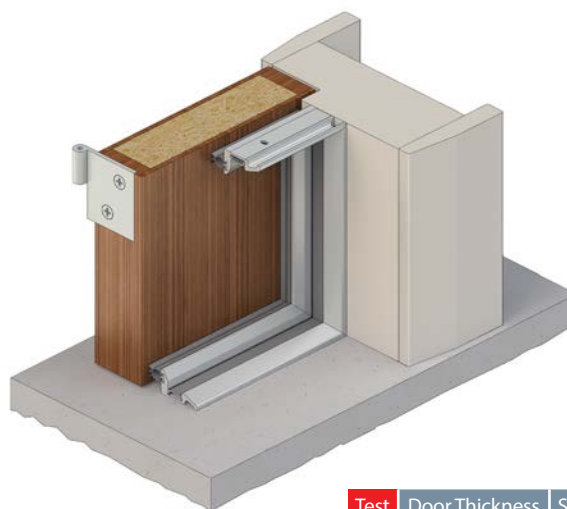

Test	Door Thickness	STC	Rw
44	45mm	30	30

RP93Si RP71Si RP97Si



Test	Door Thickness	STC	Rw
45	45mm	31	31

RP93Si RP71Si RP110Si

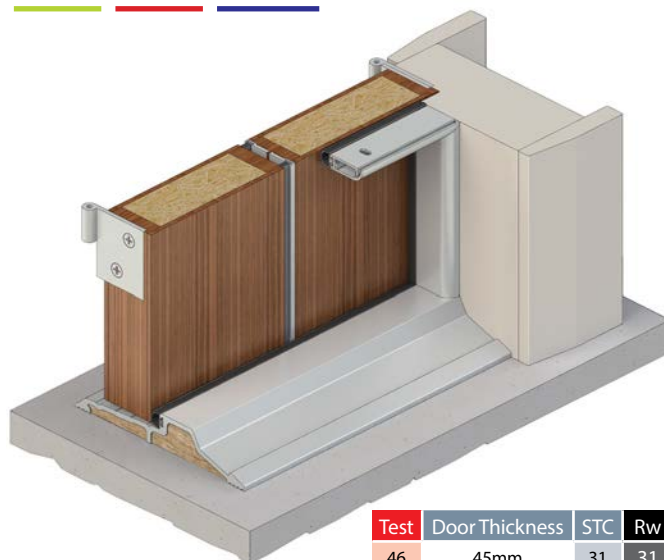

Test	Door Thickness	STC	Rw
46	45mm	31	31





RP118Si RP71Si RP117Si

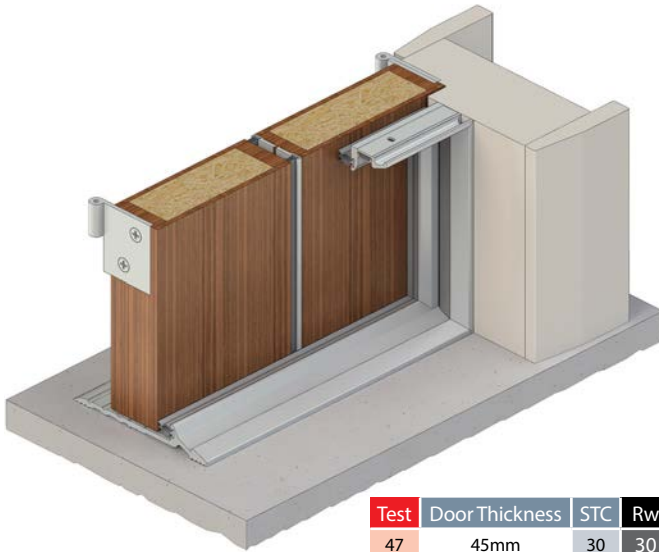

Test	Door Thickness	STC	Rw
47	45mm	30	30

RP118Si RP8Si RP16Si

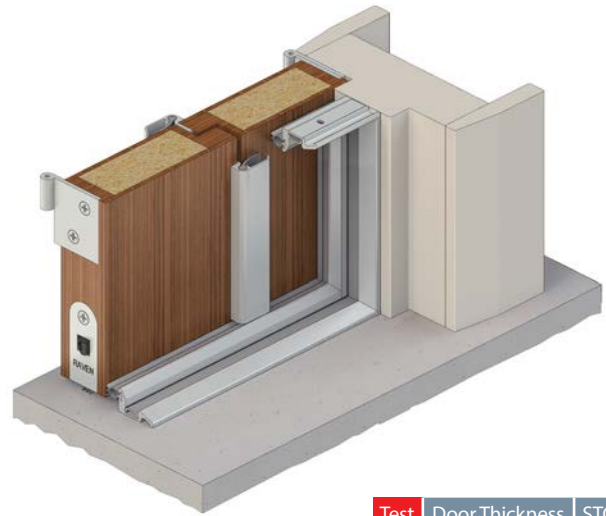

Test	Door Thickness	STC	Rw
48	45mm	31	31

Test	Raven Door Seals	Frequency (Hertz) vs STL (dB)																			
		STC	Rw	100	125	160	200	250	315	400	500	630	800	1000	1250	1600	2000	2500	3150	4000	5000
Single Doors																					
35mm Solid Core Doors																					
	*FULLY CAULKED DOOR	30	30	20.7	21.0	20.7	26.8	22.2	26.7	24.4	25.3	27.9	28.5	28.9	30.2	32.3	34.4	35.5	37.2	37.6	37.6
42	RP47Si	30	30	20.6	20.9	20.4	26.7	22.2	26.6	24.3	25.2	27.7	28.4	28.8	30.0	31.6	33.7	35.3	36.8	37.4	37.5
44mm Solid Core Doors																					
	*FULLY CAULKED DOOR	33	33	21.6	20.6	23.9	26.0	25.2	27.5	29.2	30.1	29.7	30.6	31.1	31.9	33.7	35.7	36.8	38.0	38.9	38.5
43	RP47Si	32	32	21.5	20.5	23.2	26.0	25.2	27.4	29.0	29.4	30.5	31.0	31.6	32.7	34.8	36.5	36.8	37.5	38.6	38.4
45mm Solid Core Doors																					
44	RP118Si	30	30	22.1	26.4	30.1	29.8	30.9	29.4	29.1	29.6	26.0	25.9	27.5	29.1	31.1	33.3	35.1	36.4	38.6	37.5
Pairs of Doors																					
45mm Solid Core Doors																					
	NO DOOR SEALS	22	22	13.9	16.8	19.3	18.8	21.3	20.2	19.9	21.2	21.2	22.0	23.5	23.7	22.7	21.5	21.6	19.2	17.6	17.2
	*FULLY CAULKED DOOR	31	31	25.1	27.8	29.9	30.4	31.6	30.7	29.5	30.1	27.0	26.3	27.8	30.0	32.5	35.2	37.4	39.6	41.1	40.6
45	RP93Si RP71Si RP97Si	31	31	23.0	26.3	29.6	29.9	31.4	31.0	30.2	31.2	27.6	26.4	28.3	28.8	30.9	34.0	36.5	31.0	40.9	40.9
46	RP93Si RP71Si RP110Si	31	31	22.0	26.5	30.0	30.3	31.8	31.0	30.0	31.1	27.5	25.9	28.0	29.0	30.0	33.1	36.2	37.9	40.1	39.6
47	RP118Si RP71Si RP117Si	30	30	22.1	26.4	30.1	29.8	30.9	29.4	29.1	29.6	26.0	25.9	27.5	29.1	31.1	33.3	35.1	36.4	38.6	37.5
48	RP118Si RP8Si RP16Si	31	31	20.7	22.7	26.5	27.0	27.6	29.1	29.6	30.7	29.4	27.3	27.5	28.1	30.3	32.1	33.4	33.9	36.2	37.3

\*Theoretical maximum achievable.





### Acoustic Door Fabricators

Acoustic door fabricators increasingly use Raven door sealing systems in their door sets to achieve maximum acoustic performance. Some are detailed below. Techwide Engineering Ltd. manufacture acoustic rated doors featuring Raven seals, that have been independently tested and certified to Rw52 (STC 52).



RP78Si RP530 RP70

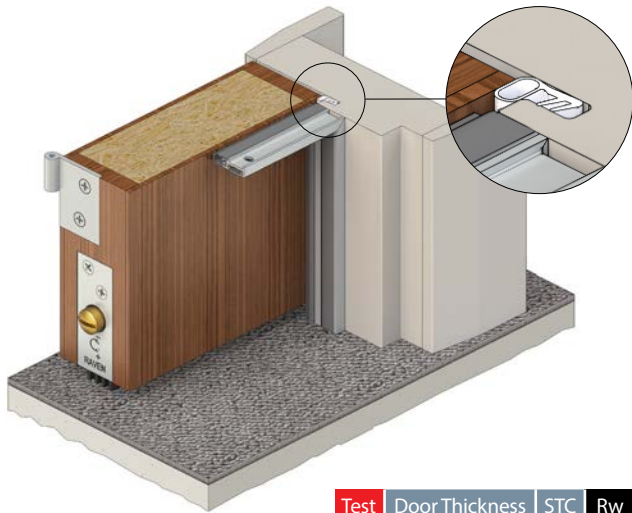

Test	Door Thickness	STC	Rw
49	54mm	41	41

RP78Si RP530 RP38 RP16Si

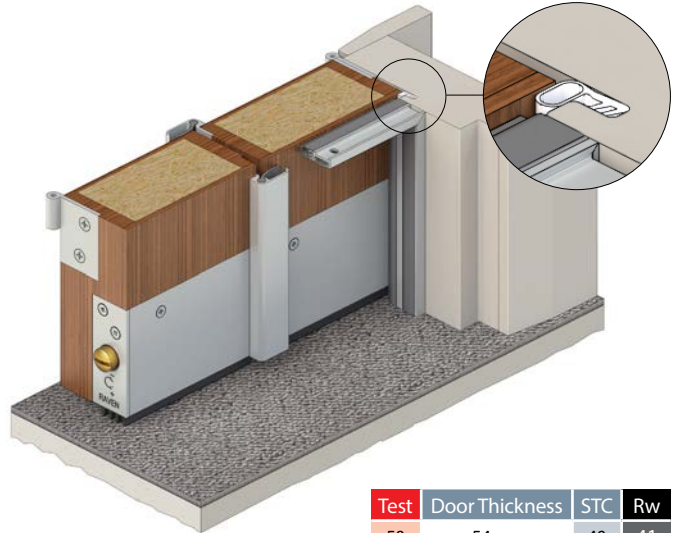

Test	Door Thickness	STC	Rw
50	54mm	40	41

RP78Si RP2004F RP8Si RP120

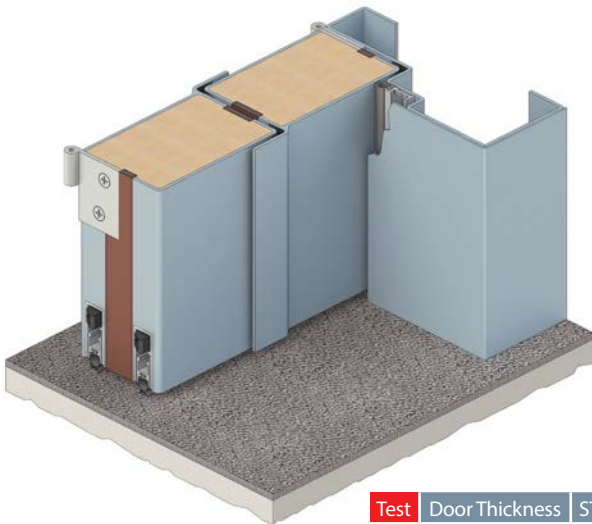

Test	Door Thickness	STC	Rw
51	60mm	46	46

RP78Si RP2004F RP8Si RP120 ^RP71

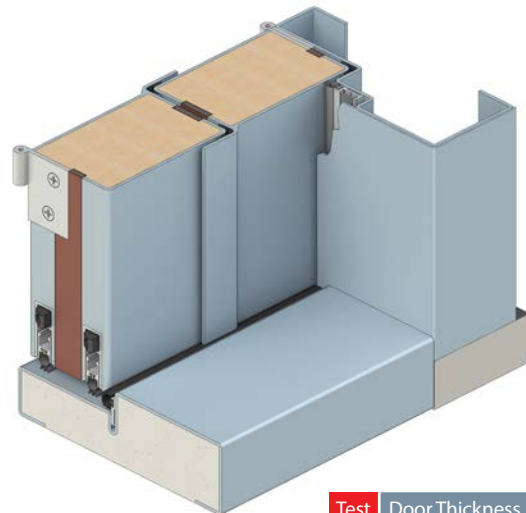

Test	Door Thickness	STC	Rw
52	60mm	48	49

^RP71 with RP393Si gasket



### NCO HOKLAS Certified Timber and Metal Acoustic Doors

The acoustic tests below have been carried out in a HOKLAS Accredited laboratory registered by the Hong Kong Accreditation Service, recognised by NATA. These acoustic tests have been conducted by Techwide Engineering Ltd. (NCO Doors) at normal door closing forces under BS EN ISO 140.3 and BS EN ISO 717.1, to which the laboratory is registered in accordance with the terms of H.K.A.S.

Test	Raven Door Seals	Frequency (Hertz) vs STL (dB)																			
		STC	Rw	100	125	160	200	250	315	400	500	630	800	1000	1250	1600	2000	2500	3150	4000	5000
100mm Thick Brick Wall																					
	NO OPENING	44	44	37.0	38.0	37.0	37.0	33.0	34.0	36.0	39.0	41.0	44.0	47.0	49.0	52.0	55.0	57.0	59.0	60.0	62.0
Single Doors																					
50mm Timber Solid Core Doors																					
	NO DOOR SEALS	22	23	13.5	19.5	19.9	20.5	20.2	21.6	22.6	22.3	24.5	23.3	23.7	22.7	20.0	20.8	23.1	21.6	23.0	21.9
	*FULLY CAULKED DOOR	34	35	17.2	26.0	28.4	27.0	29.6	30.5	30.5	27.9	31.2	31.2	33.1	33.0	36.8	39.1	39.3	41.1	43.1	45.1
	RP120 RP70	33	34	20.4	27.5	22.9	30.8	27.0	27.7	29.3	31.0	30.4	31.7	30.5	31.4	34.7	37.1	39.1	39.2	40.2	40.5
	RP530 RP38	33	33	25.2	28.0	27.3	31.9	28.4	29.6	29.0	31.0	31.0	30.7	30.3	31.8	33.5	36.1	36.4	37.1	36.8	34.6
	RP530 RP70	33	33	17.5	27.9	28.8	31.8	29.9	30.1	30.1	28.6	30.4	31.3	32.0	31.9	34.9	36.4	36.0	35.1	36.0	36.7
	RP530 RP70 RP110Si	34	34	19.4	27.4	28.8	31.4	30.3	31.4	30.4	29.0	30.8	31.2	32.3	31.8	35.4	37.3	37.9	38.1	38.5	38.6
	RP78Si RP530 RP70	33	34	22.2	25.0	23.0	29.2	27.2	27.1	29.0	31.9	31.4	31.9	31.8	31.6	34.4	38.1	39.5	39.7	41.0	40.9
	RP78Si RP530 RP70 RP117Si	35	34	25.8	29.9	26.1	29.9	30.6	30.4	29.5	30.2	33.6	33.6	32.7	34.5	36.1	39.1	39.8	40.4	41.6	42.4
53mm Proprietary Acoustic Timber Doors (High Density Core)																					
	RP78Si RP120 RP70	38	39	24.3	29.0	29.9	32.2	31.0	31.4	31.0	31.5	33.6	35.0	37.5	41.4	44.8	48.6	50.6	51.3	51.7	51.8
	RP78Si RP530 RP70 RP117Si	37	38	18.3	30.0	31.7	32.9	31.2	32.2	33.9	33.2	34.0	34.1	35.0	36.0	38.2	42.2	43.7	43.9	45.4	47.8
	RP78Si RP120 RP70 RP117Si	39	40	25.9	33.2	34.7	33.9	33.5	33.7	33.1	33.6	34.6	35.3	38.0	41.7	46.5	50.2	52.0	52.6	53.5	54.1
54mm Proprietary Acoustic Timber Door (Composite Core #1)																					
49	RP78Si RP530 RP70	41	41	25.3	33.3	33.0	36.0	33.2	35.3	34.9	36.9	38.2	40.6	41.0	41.4	42.3	43.2	44.3	46.9	49.0	49.1
54mm Proprietary Metal Door (Composite Core #2)																					
	RP78Si RP530 RP70	45	45	19.6	32.0	34.5	37.6	36.1	36.9	36.4	40.3	44.2	44.9	46.9	48.9	51.1	52.8	54.5	55.7	56.9	56.8
54mm Proprietary Acoustic Metal Door (Composite Core #3)																					
	RP78Si RP120 RP70 ^RP71	43	44	31.6	32.0	31.4	32.0	35.2	37.2	40.0	43.4	44.9	47.4	47.6	47.9	48.8	51.4	53.5	55.0	53.8	53.3
54mm Proprietary Acoustic Metal Door (Composite Core #4)																					
	*FULLY CAULKED DOOR	47	48	32.2	34.3	34.6	35.5	38.5	39.4	40.6	42.4	44.6	47.4	48.3	49.7	50.6	52.2	53.1	53.4	55.5	57.5
	RP78Si RP120 RP70 ^RP71	46	47	31.6	34.5	34.8	34.9	36.0	39.3	40.4	41.0	42.8	45.9	47.3	48.3	47.4	49.2	51.4	53.7	55.6	58.3
Pairs of Doors																					
54mm Timber Doors																					
50	RP78Si RP530 RP38 RP16Si	40	41	26.8	31.7	28.6	33.4	34.0	34.2	33.2	35.4	37.9	41.5	42.0	43.5	45.3	45.1	42.1	41.0	42.8	47.3
54mm Metal Doors (Composite Core #1)																					
	RP78Si RP530 RP70 RP110Si	40	42	23.6	29.7	23.5	28.5	25.2	31.4	38.1	40.3	43.6	47.2	49.3	49.1	54.2	56.4	53.6	53.5	56.5	
	RP78Si RP530 RP70	39	39	26.9	29.7	23.4	28.6	25.7	32.2	36.8	36.2	36.5	39.1	41.3	41.7	44.5	46.5	45.7	45.2	43.6	44.2
54mm Metal Doors (Composite Core #2)																					
	RP78Si RP120 RP70 RP120 ^RP71	45	45	32.4	30.4	32.1	38.9	40.6	41.9	43.2	43.5	44.3	45.9	47.0	44.7	41.8	41.6	45.4	50.4	51.9	50.9
60mm Metal Doors																					
51	RP78Si RP2004F RP8Si RP120	46	46	29.0	32.0	32.0	30.0	37.0	42.0	43.0	43.0	45.0	47.0	47.0	49.0	49.0	49.0	51.0	54.0	56.0	56.0
52	RP78Si RP2004F RP8Si RP120 ^RP71	48	49	30.0	32.2	33.6	30.1	37.4	44.3	44.7	45.0	47.8	51.1	51.7	53.2	51.7	51.7	53.3	55.7	58.4	57.9
Interconnecting Doors																					
50mm Timber Solid Core Doors x 2 sets																					
	RP530 RP70	44	44	22.7	34.0	36.0	39.1	35.9	36.9	35.9	38.5	42.4	43.5	45.1	44.8	50.6	54.4	57.7	60.9	62.4	63.5
54mm Thick Single Leaf Proprietary Acoustic Metal Doors (Composite Core #3) x 2 sets																					
	RP78Si RP120 RP70 ^RP71	52	52	36.4	39.2	39.3	40.5	40.9	42.0	44.2	47.2	50.6	55.5	58.5	62.2	64.6	65.5	68.3	68.8	69.9	71.2

\*Theoretical maximum achievable.

^RP71 with RP393Si gasket.

Data reproduced by courtesy of Techwide Engineering Ltd (Hong Kong).

Results above represent the average decibel (dB) reduction as Sound Transmission Loss (STL), taken from 18 one third octave bands 100 - 5000 hertz. The Sound Transmission Class (STC) indicates the rating for each door and sealing system using frequencies from 125Hz to 4000Hz in one third octave bands. The Rw rating uses the frequencies from 100Hz to 3150Hz in one third octave bands, taking into account the lower frequency bands of the spectrum.



## Door Bottom Seals

Seals designed to fill the gap between the bottom of a door and the floor underneath, are referred to as door bottom seals. Common forms comprise sweep seals that have an aluminium holder with a flexible strip of rubber or brush strip mounted to the door bottom. They are designed to sweep across the floor or engage a raised threshold plate so they clear the floor as the door opens.

Automatic door bottom seals are mechanically spring loaded seals that lift clear of the floor as the door opens and seal tight when the door is closed. Automatic door bottom seals can be face mounted and some models can be fully concealed. They operate over uneven floor surfaces and like sweep seals can be used with Raven threshold plates that offer added protection against rain infiltration where doorways may be exposed to more severe weather conditions.

Most Raven door bottom seals are easily adjusted after installation without removing the door. This ensures an optimum seal is achieved and maximum performance is maintained in the event of minor building movement.

# Automatic Door Bottom Seals

## RP3



A cam activated, lifting action, automatic door bottom seal. It is quick and easy to install without cutting or removing the door and uses concealed fasteners. This DIY product has been granted an Australian Design Award. Ideal for residential and light commercial applications such as motels and retirement villages.

Can be used in conjunction with Raven threshold plates.

**Location:** Bottom of single inward opening butt hinged doors.

**Min/Max Gap:** 3mm to 16mm.

**Finish:** Satin clear (silver), bronze or bright gold anodised aluminium (15µm).

**Fixing:** Screw fix. Zinc plated, cross recess head S.T. screws supplied. Fixing holes are pre-slotted.

**Seal:** RP303. Black EPDM or TPE.

**Sizes:** 915mm and 1220mm maximum (between door stops).

### Approvals

**Fire** Gasket flammability index < 5 when tested to AS1530.2.

**Energy** NCC Pt. 3.12.3.3 & J3.4.

**Durability** Tested to over 1,000,000 operating cycles without failure.

**Patented.**

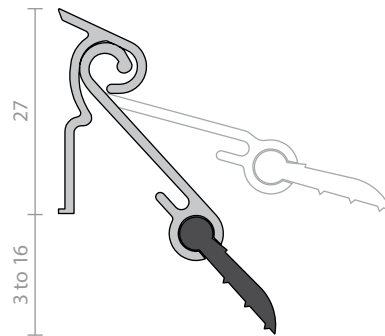

With new superior closing cam!

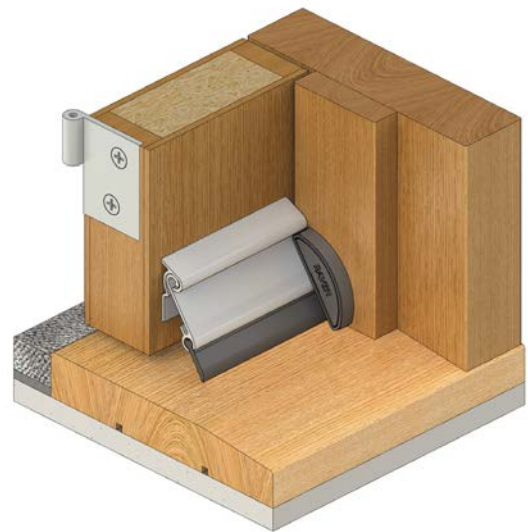

## RP8Si



A concealed, automatic door bottom seal that is spring loaded to lift clear of the floor when the door is opened. It is acoustically designed, featuring silicon gaskets for medium temperature smoke and fire door applications. Operated automatically by pressure against the door jamb on its adjustable strike. RP8Si can also be fitted into the bottom rail of a metal door by the fabricator. Has a level adjustment to achieve an optimum seal.

**Location:** Fully morticed into a 15mm x 34mm groove into the bottom of single and double butt hinged timber and metal doors.

**Min/Max Gap:** 3mm to 13mm.

**Finish:** Satin clear (silver), bronze or black anodised aluminium (15µm).

**Fixing:** Concealed screw fix with colour matched stainless steel escutcheon plates and screws supplied.

**Seal:** RP308Si. Grey silicon rubber (SE).

**Sizes:** 1220mm, 1070mm, 920mm, 820mm, 600mm, 380mm to 295mm(min). Seals cut back to exact size.

### Approvals

UL Cert. G.VYI.R37913

ANSI/BHMA A156.22

**Acoustic AUS/NZ:** NCC Spec. F5.5.

**UK/EU:** Approved Document E. Rated to BS EN ISO 717.1.

**Fire AUS/NZ:** NCC Spec. C3.4.

AS1530.4 & AS/NZS 1905.1. NZ BC Compliance Doc. C/AS1 6.19.2 & App. C6.1.1.

**UK/EU:** Approved Document B. BS 476 Pt. 20 & 22 (similar to BS EN 1634-1).

**FRL & FRR-/240/60 and FD240.** Gasket flammability index 1 when tested to AS1530.2.

**Smoke** NCC Spec. C3.4. AS1530.7 & BS EN 1634-3. Meets smoke leakage rates specified in AS6905 & EN 13501-2 "Sa", "Sm".

**Energy** NCC Pt. 3.12.3.3 & J3.4.

**Design for Access and Mobility**

High efficiency mechanism to assist with the closing force requirements detailed in AS1428.1.

**Durability** Tested to over 1,000,000 operating cycles without failure.

**Patented.**

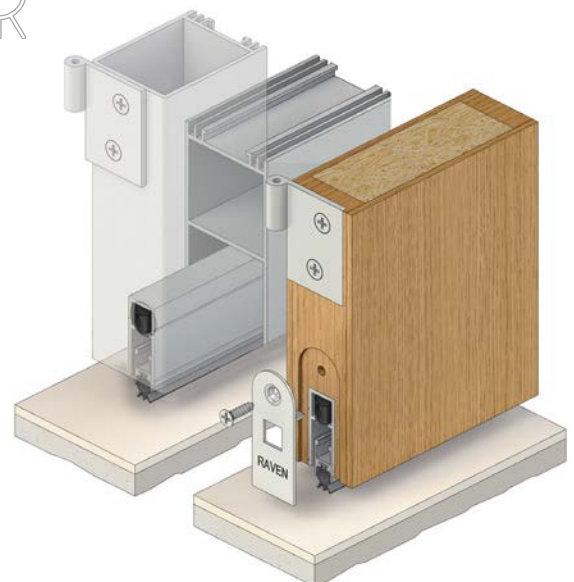
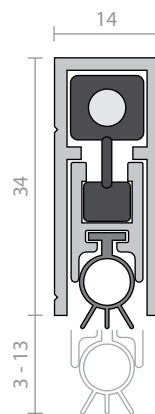

Door Bottom Seals

## RP35Si



An adjustable, automatic door bottom seal that is spring loaded to lift clear of the floor when the door is opened. It is acoustically designed, featuring silicon gaskets for medium temperature smoke and fire door applications. Operated automatically by pressure against the door jamb or stop on its adjustable strike.

**Location:** Face mounted or semi-morticed into the bottom of solid core single and double butt hinged doors. The RP35Si can also be face mounted to the bottom of metal doors.

**Min/Max Gap:** 3mm to 13mm.

**Finish:** Satin clear (silver) or bronze anodised aluminium (15µm).

**Fixing:** Concealed screw fix. Zinc plated, cross recess head S.T. screws, colour matched escutcheon plates and cover strip supplied. Fixing holes are pre-slotted.

**Seal:** RP308Si. Grey silicon rubber (SE).

**Sizes:** 1220mm, 1070mm, 920mm, 820mm, 600mm, 380mm to 295mm(min). Seals cut back to exact size.

### Approvals

ANSI/BHMA A156.22

**Acoustic AUS/NZ:** NCC Spec. F5.5.  
**UK/EU:** Approved Document E. Rated to BS EN ISO 717.1.

**Fire AUS/NZ:** NCC Spec. C3.4.  
AS1530.4 & AS/NZS 1905.1. NZ BC Compliance Doc. C/AS1 6.19.2 & App. C6.1.1.

**UK/EU:** Approved Document B.  
BS 476 Pt. 20 & 22 (similar to BS EN 1634-1).

**FRL & FRR-/240/60 and FD240.** 🔥  
Gasket flammability index 1 when tested to AS1530.2.

**Smoke** NCC Spec. C3.4. AS1530.7 & BS EN 1634-3. Meets smoke leakage rates specified in AS6905 & EN 13501-2 "Sa", "Sm".

**Energy** NCC Pt. 3.12.3.3 & J3.4.

**Design for Access and Mobility**  
High efficiency mechanism to assist with the closing force requirements detailed in AS1428.1.

**Durability** Tested to over 1,000,000 operating cycles without failure.

**Patented, Registered Design.**

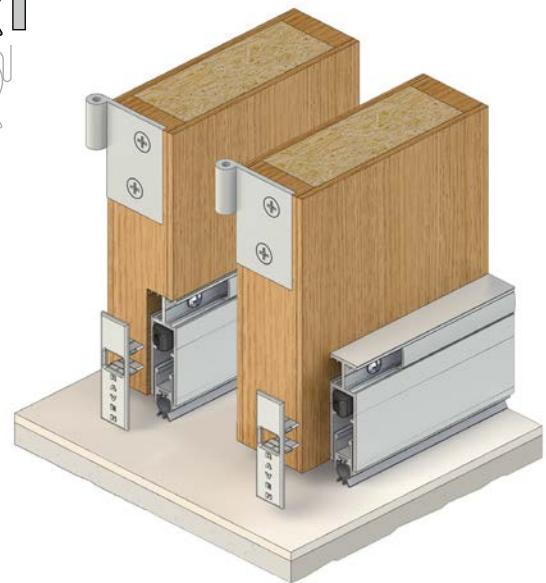
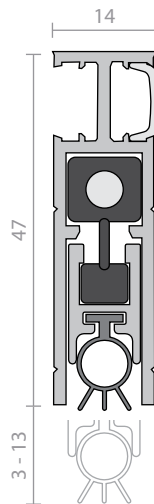

## RP38



A heavy duty, automatic door bottom seal that is spring loaded to lift clear of the floor when the door is opened. It is self levelling and reversible for left and right handed operation. Acoustically designed, it features an EPDM foam gasket for acoustic door applications and doubles as a kick plate when semi-morticed. Operated automatically by pressure against the door jamb or stop on its adjustable brass strike.

**Location:** Face mounted or semi-morticed into bottom of single and double butt hinged doors. For semi-mortice minimum door thickness of 50mm for rebated meeting stiles and 40mm for plain meeting stiles is required. The RP38 can also be face mounted to the bottom of metal doors.

**Min/Max Gap:** 3mm to 13mm.

**Finish:** Satin clear (silver) anodised aluminium (15µm) or paint at extra cost (page 7).

**Fixing:** Screw fix. Colour matched escutcheon plates and zinc plated, cross recess head S.T. screws supplied.

**Seal:** RP338. Black EPDM sponge (SE).

**Sizes:** 1500mm, 1220mm, 1070mm, 920mm, 610mm, 450mm to 300mm(min). Seals cut back to exact size.

### Approvals

**Acoustic AUS/NZ:** NCC Spec. F5.5.  
**UK/EU:** Approved Document E. Rated to BS EN ISO 717.1.

**Fire & Smoke AUS/NZ:** NCC Spec. C3.4. AS1530.4 & AS/NZS 1905.1. NZ BC Compliance Doc. C/AS1 6.19.2 & App. C6.1.1.

**UK/EU:** Approved Document B.  
BS 476 Pt. 20 & 22 (similar to BS EN 1634-1).

**FRL & FRR-/240/30 and FD240.** 🔥

**Energy** NCC Pt. 3.12.3.3 & J3.4.

**Design for Access and Mobility**  
High efficiency mechanism to assist with the closing force requirements detailed in AS1428.1.

**Durability** Tested to over 1,000,000 operating cycles without failure.

**Patented.**

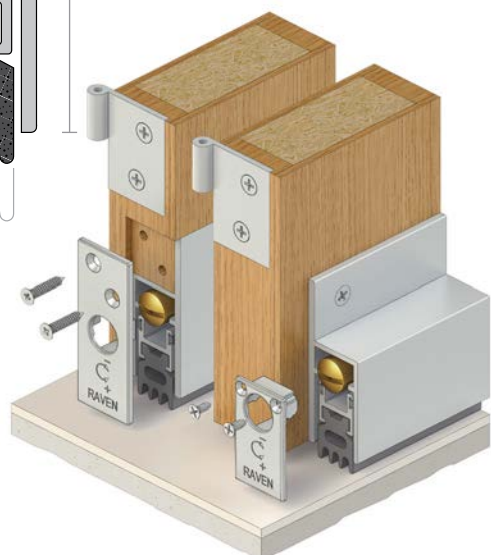
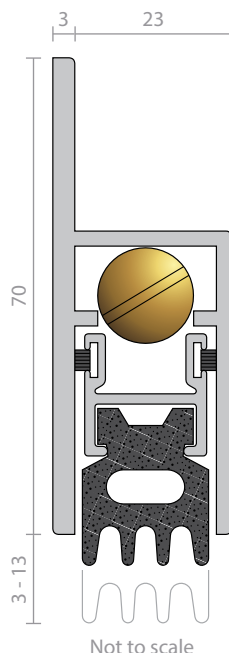

## RP38Si



A heavy duty, automatic door bottom seal that is spring loaded to lift clear of the floor when the door is opened. It is self levelling and reversible for left and right handed operation. Acoustically designed, it features a silicon gasket for medium temperature smoke and fire door applications. Doubles as a kick plate when semi-morticed. Operated automatically by pressure against the door jamb or stop on its adjustable brass strike.

**Location:** Face mounted or semi-morticed into bottom of single and double butt hinged doors. For semi-mortice minimum door thickness of 50mm for rebated meeting stiles and 40mm for plain meeting stiles is required. Can be face mounted to the bottom of metal doors.

**Min/Max Gap:** 3mm to 13mm.

**Finish:** Satin clear (silver), bronze anodised aluminium (15µm) or paint at extra cost (page 7).

**Fixing:** Screw fix. Colour matched escutcheon plates and zinc plated, cross recess head S.T. screws supplied.

**Seal:** RP338Si. Grey silicon rubber (SE).

**Sizes:** 1500mm, 1220mm, 1070mm, 920mm, 610mm, 450mm to 300mm(min). Seals cut back to exact size.

### Approvals

**UL** Cert. GVYI.R37913  
**Acoustic AUS/NZ:** NCC Spec. F5.5.  
**UK/EU:** Approved Document E. Rated to BS EN ISO 717.1.

**Fire AUS/NZ:** NCC Spec. C3.4. AS1530.4 & AS/NZS 1905.1. NZ BC Compliance Doc. C/AS1 6.19.2 & App. C6.1.1.

**UK/EU:** Approved Document B. BS 476 Pt. 20 & 22 (similar to BS EN 1634-1).

**FRL & FRR-/240/60 and FD240.** 🔥  
 Gasket flammability index 1 when tested to AS1530.2.

**Smoke** NCC Spec. C3.4. AS1530.7 & BS EN 1634-3. Meets smoke leakage rates specified in AS6905 & EN 13501-2 "Sa", "Sm".

**Energy** NCC Pt. 3.12.3.3 & J3.4.

### Design for Access and Mobility

High efficiency mechanism to assist with the closing force requirements detailed in AS1428.1.

**Durability** Tested to over 1,000,000 operating cycles without failure.

**Patented, Registered Design.**

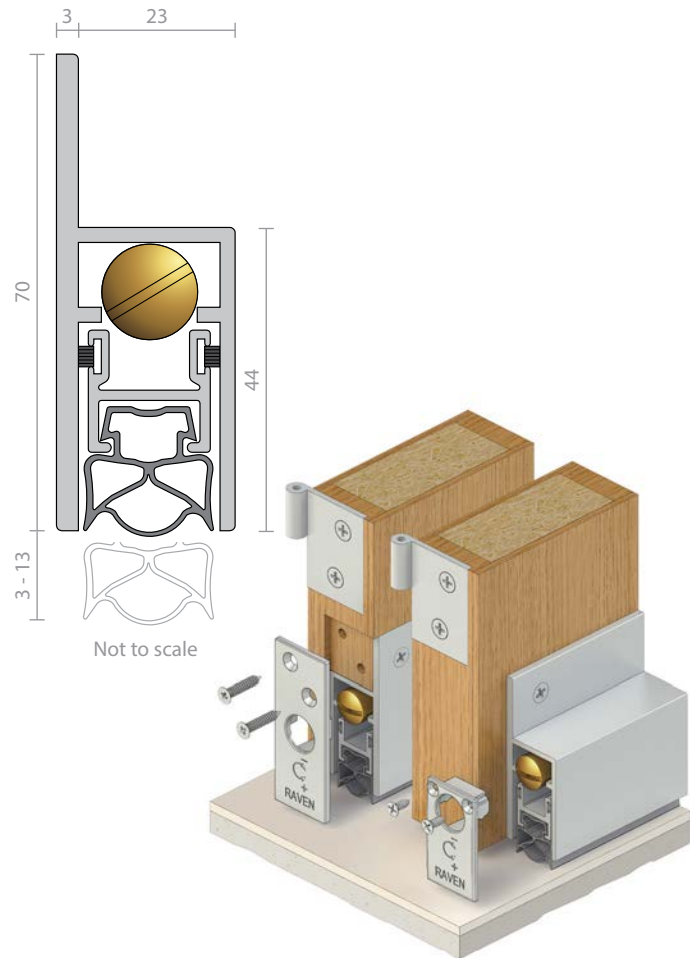

## RP60



An adjustable, automatic door bottom seal which is spring loaded to lift clear of the floor when the door is opened. Operated automatically by pressure against the door stop on its adjusting screw and incorporates concealed fixings. The RP60 is self levelling and can be used in conjunction with Raven threshold plates such as the RP13 and RP82.

**Location:** Face mounted on the bottom of single and double butt hinged doors.

**Min/Max Gap:** 3mm to 15mm.

**Finish:** Satin clear (silver), bronze or bright gold anodised aluminium (15µm).

**Fixing:** Concealed screw fix. Zinc plated, cross recess head S.T. screws and cover strip supplied. Fixing holes are pre-slotted.

**Seal:** RP460. Black TPE.

**Sizes:** 915mm maximum (between door stops). Unit cuts back to 450mm (min).

### Approvals

**Fire AUS/NZ:** NCC Spec. C3.4. AS1530.4 & AS/NZS 1905.1. NZ BC Compliance Doc. C/AS1 6.19.2 & App. C6.1.1.

**UK/EU:** Approved Document B. BS 476 Pt. 20 & 22 (similar to BS EN 1634-1).

**FRL & FRR-/240/30 and FD240.** 🔥

**Energy** NCC Pt. 3.12.3.3 & J3.4.

### Design for Access and Mobility

High efficiency mechanism to assist with the closing force requirements detailed in AS1428.1.

**Durability** Tested to over 500,000 operating cycles without failure.

**Patented.**

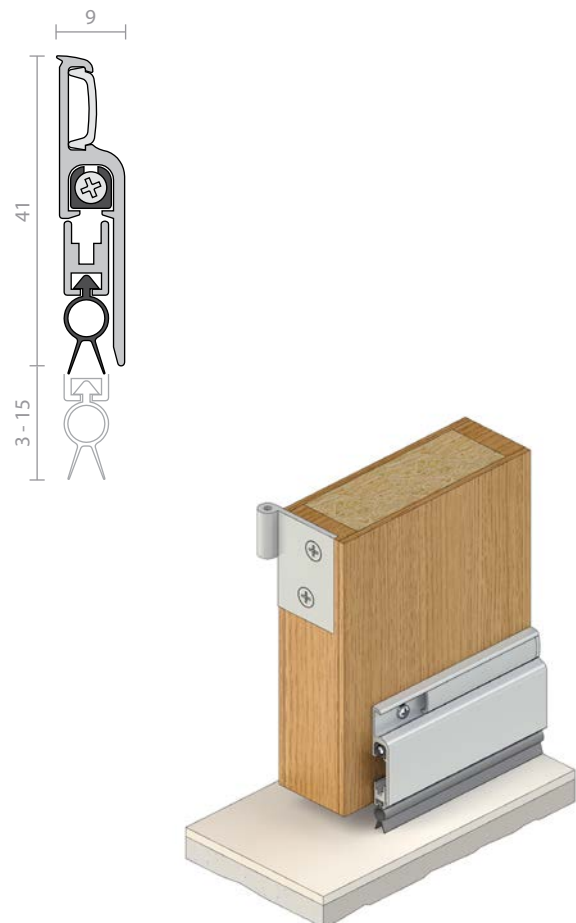

## RP70



A heavy duty, fully morticed, automatic door bottom seal that is spring loaded to lift clear of the floor when the door is opened. It is self levelling and reversible for left and right handed operation. Acoustically designed, featuring an EPDM foam gasket for acoustic door applications. RP70 is operated automatically by pressure against the door jamb on its adjustable brass strike.

**Location:** Fully morticed into the bottom of single and double butt hinged doors (minimum door thickness of 45mm). For double doors, plain meeting stiles are required.

**Min/Max Gap:** 3mm to 13mm.

**Finish:** Satin clear (silver) anodised aluminium (15µm).

**Fixing:** Screw fix. Colour matched escutcheon plates and zinc plated, cross recess head S.T. screws supplied.

**Seal:** RP338. Black EPDM sponge (SE).

**Sizes:** 1500mm, 1220mm, 1070mm, 920mm, 610mm, 450mm to 300mm(min). Seals cut back to exact size.

### Approvals

**Acoustic AUS/NZ:** NCC Spec. F5.5.  
**UK/EU:** Approved Document E. Rated to BS EN ISO 717.1.

**Fire AUS/NZ:** NCC Spec. C3.4.  
AS1530.4 & AS/NZS 1905.1.

**UK/EU:** Approved Document B.  
BS 476 Pt. 20 & 22 (similar to BS EN 1634-1).

**FRL & FRR-/240/30 and FD240.** 🔥

**Energy** NCC Pt. 3.12.3.3 & J3.4.

### Design for Access and Mobility

High efficiency mechanism to assist with the closing force requirements detailed in AS1428.1.

**Durability** Tested to over 1,000,000 operating cycles without failure.

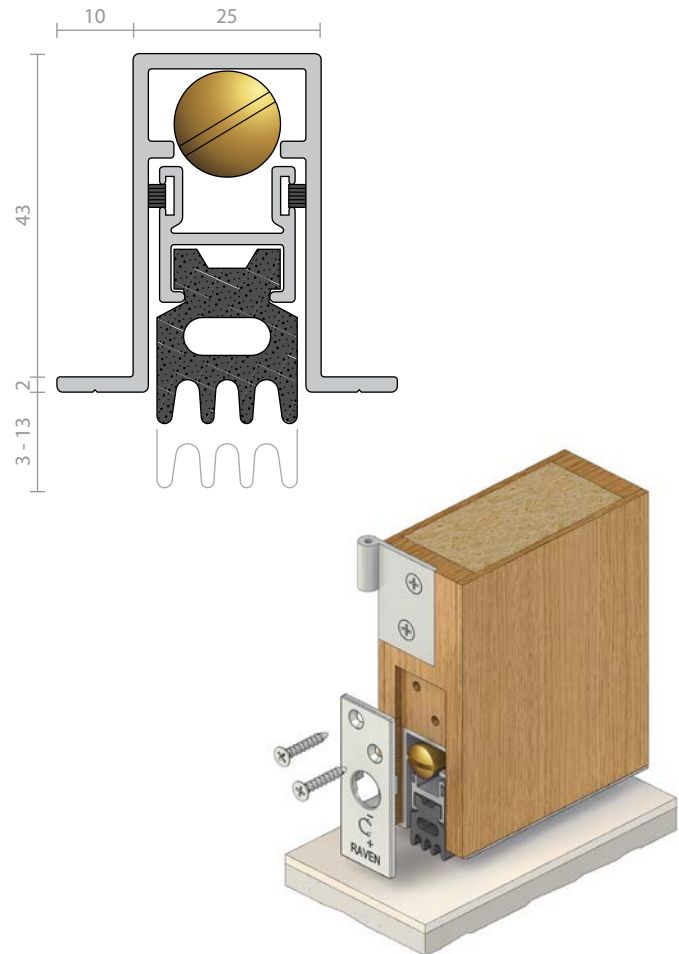

## RP70Si



A heavy duty, fully morticed, automatic door bottom seal that is spring loaded to lift clear of the floor when the door is opened. It is self levelling and reversible for left and right handed operation. Acoustically designed, featuring a silicon gasket for smoke and fire door applications. RP70Si is operated automatically by pressure against the door jamb on its adjustable brass strike.

**Location:** Fully morticed into the bottom of single and double butt hinged doors (minimum door thickness of 45mm). For double doors, plain meeting stiles are required.

**Min/Max Gap:** 3mm to 13mm.

**Finish:** Satin clear (silver) anodised aluminium (15µm).

**Fixing:** Screw fix. Colour matched escutcheon plates and zinc plated, cross recess head S.T. screws supplied.

**Seal:** RP338Si. Grey silicon rubber (SE).

**Sizes:** 1500mm, 1220mm, 1070mm, 920mm, 610mm, 450mm to 300mm(min). Seals cut back to exact size.

### Approvals

UL Cert. GVV1.R37913

**Fire AUS/NZ:** NCC Spec. C3.4.  
AS1530.4 & AS/NZS 1905.1. NZ BC Compliance Doc. App. C6.1.1.

**UK/EU:** Approved Document B.  
BS 476 Pt. 20 & 22 (similar to BS EN 1634-1).

**FRL & FRR-/240/30 and FD240.** 🔥  
Gasket flammability index 1 when tested to AS1530.2.

**Smoke** NCC Spec. C3.4. AS1530.7 & BS EN 1634-3. Meets smoke leakage rates specified in AS6905 & EN 13501-2 "Sa", "Sm".

**Energy** NCC Pt. 3.12.3.3 & J3.4.

### Design for Access and Mobility

High efficiency mechanism to assist with the closing force requirements detailed in AS1428.1.

**Durability** Tested to over 1,000,000 operating cycles without failure.

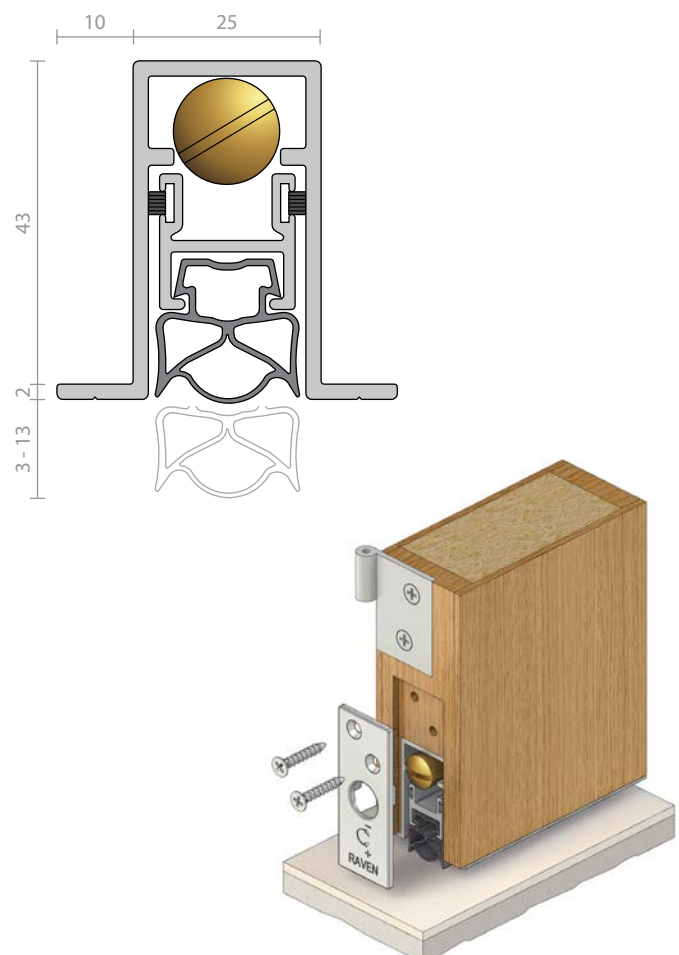



## RP92Si



A heavy duty, adjustable, automatic door bottom seal that is spring loaded to lift clear of the floor when the door is opened. Ideal for butt hinged doors with large gaps such as where internal access ramps are used and large clearances are necessary. The RP92Si can accommodate ramped floors/sills with gradients up to 1:8 and utilises an aesthetic extruded aluminium cover for concealed fixing.

**Location:** Face mounted on the bottom of timber or metal single and double butt hinged doors.

**Min/Max Gap:** 25mm to 55mm. Larger gaps can be accommodated if set lower on the door bottom and smaller gaps if set higher on the door bottom (user determined).

**Finish:** Satin clear (silver) anodised aluminium (15µm) with black anodised inner.

**Fixing:** Concealed screw fix. Adhesive striker plate, escutcheon plates and zinc plated, cross recess head S.T. screws supplied.

**Seal:** RP347Si. Black silicon rubber (SE).

**Sizes:** 1200mm, 1070mm, 920mm, 820mm to 600mm(min). Seals cut back to exact size.

### Approvals

**Access & Mobility AUS/NZ:** NCC D3, D3.2. Designed with high efficiency mechanism to assist with the closing force requirements detailed in AS1428.1.

**UK/EU:** Approved Document M.

**Fire** Gasket flammability index 1 when tested to AS1530.2.

**Smoke AUS/NZ:** NCC Spec. C3.4. NZ BC Compliance Doc. C/AS1 6.19.2(b). **UK/EU:** Approved Document B.

**Energy** NCC Pt. 3.12.3.3 & J3.4.

**Durability** Tested to over 1,000,000 operating cycles without failure.

**Patented.**

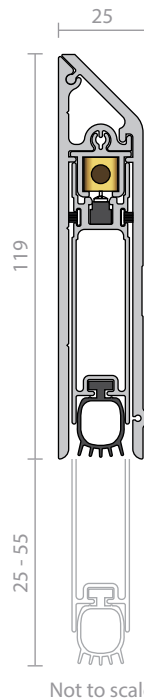

## RP99Si



A heavy duty, adjustable, automatic door bottom seal that is spring loaded to lift clear of the floor when the door is opened. Acoustically designed, with a silicon gasket for medium temperature smoke applications. Operated automatically by pressure on the door jamb or stop by its adjustable strike. Includes aluminium cover for concealed fixing for face mounted installation.

**Location:** Face mounted, semi-morticed or fully morticed into single and double solid core butt hinged doors. Can be fitted into the bottom rail of metal doors by the fabricator. Minimum door thickness of 40mm for semi and fully morticed installations. For double door fully morticed installations, plain meeting stiles required.

**Min/Max Gap:** 3mm to 19mm.

**Finish:** Satin clear (silver), bronze anodised aluminium (15µm) or paint at extra cost (page 7).

**Fixing:** Concealed screw fix. Zinc plated, cross recess head S.T. screws supplied. Colour matched escutcheon plates and face mount aluminium angle included.

**Seal:** RP347Si. Black silicon rubber (SE).

**Sizes:** 1220mm, 1070mm, 920mm, 820mm, 720mm, 600mm, 380mm to 295mm(min). Seals cut back to exact size.

### Approvals

**UL** Cert. GVYI.R37913

**Acoustic AUS/NZ:** NCC Spec. F5.5.

**UK/EU:** Approved Document E. Rated to BS EN ISO 717.1.

**Fire AUS/NZ:** NCC Spec. C3.4. AS1530.4 & AS/NZS 1905.1. NZ BC Compliance Doc. C/AS1 6.19.2 & App. C6.1.1.

**UK/EU:** Approved Document B. BS 476 Pt. 20 & 22 (similar to BS EN 1634-1).

**FRL & FRR-/240/60 and FD240.** Gasket flammability index 1 when tested to AS1530.2.

**Smoke** NCC Spec. C3.4. AS1530.7 & BS EN 1634-3. Meets smoke leakage rates specified in AS6905 & EN 13501-2 "Sa", "Sm".

**Energy** NCC Pt. 3.12.3.3 & J3.4.

**Design for Access and Mobility** High efficiency mechanism to assist with the closing force requirements detailed in AS1428.1.

**Durability** Tested to over 1,000,000 operating cycles without failure.

**Patented.**

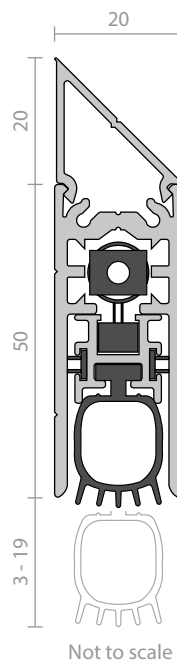

## RP126Si



An adjustable, automatic door bottom seal that is spring loaded to lift clear of the floor when the door is opened. Acoustically designed, featuring extruded silicon gaskets for medium temperature smoke applications.

RP126Si is operated automatically by pressure on the door jamb or stop by its adjustable strike.

**Location:** Face mounted or semi-morticed into the bottom of single and double solid core butt hinged doors. Minimum door thickness of 35mm recommended for semi morticed installations with plain meeting stiles. Minimum door thickness of 40mm recommended for semi-morticed installation with rebated meeting stiles. RP126Si can also be face mounted to the bottom of metal doors.

**Min/Max Gap:** 3mm to 14mm.

**Finish:** Satin clear (silver) anodised aluminium (15µm) or paint at extra cost (page 7).

**Fixing:** Screw fix. Colour matched escutcheon plates and zinc plated, cross recess head S.T. screws supplied.

**Seal:** RP3126Si. Black silicon rubber (SE).

**Sizes:** 1500mm, 1220mm, 1070mm, 920mm, 820mm, 600mm to 305mm(min). Seals cut back to exact size.

### Approvals

Cert. GVV1.R37913

**Acoustic AUS/NZ:** NCC Spec. F5.5.

**UK/EU:** Approved Document E. Rated to BS EN ISO 717.1.

**Fire AUS/NZ:** NCC Spec. C3.4. AS1530.4 & AS/NZS 1905.1. NZ BC Compliance Doc. C/AS1 6.19.2 & App. C6.1.1.

**UK/EU:** Approved Document B. BS EN 1634-1.

**FRL & FRR-/240/30.**

Gasket flammability index 1 when tested to AS1530.2.

**Smoke** NCC Spec. C3.4. AS1530.7 & BS EN 1634-3. Meets smoke leakage rates specified in AS6905 & EN 13501-2 "Sa", "Sm".

**Energy** NCC Pt. 3.12.3.3 & J3.4.

**Durability** Tested to over 1,000,000 operating cycles without failure.

**Patented, Registered Design.**

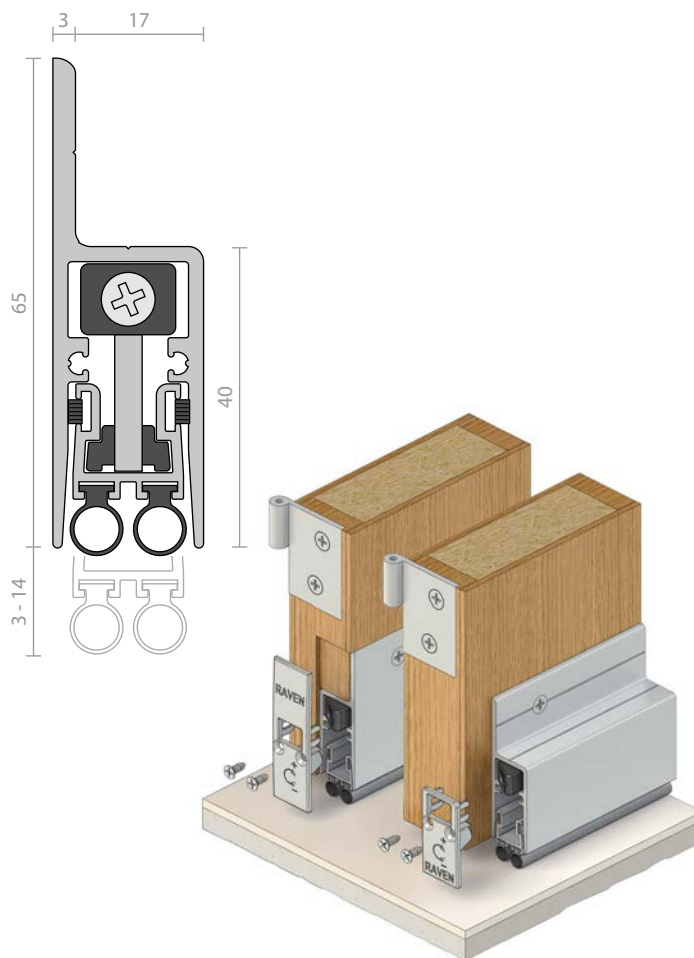

## RP127Si



An adjustable, automatic door bottom seal that is spring loaded to lift clear of the floor when the door is opened. Acoustically designed, featuring extruded silicon gaskets for medium temperature smoke applications. It is operated automatically by pressure on the door jamb by its adjustable strike.

**Location:** Fully morticed into the bottom of single and double solid core butt hinged doors (minimum door thickness of 40mm). For double doors, plain meeting stiles are required. Can also be fitted into the bottom rail of a metal door by the fabricator.

**Min/Max Gap:** 3mm to 14mm.

**Finish:** Satin clear (silver) or black anodised aluminium (15µm).

**Fixing:** Screw fix. Colour matched escutcheon plates and zinc plated, cross recess head S.T. screws supplied.

**Seal:** RP3126Si. Black silicon rubber (SE).

**Sizes:** 1500mm, 1220mm, 1070mm, 920mm, 820mm, 600mm to 305mm(min). Seals cut back to exact size.

### Approvals

Cert. GVV1.R37913

**Acoustic AUS/NZ:** NCC Spec. F5.5.

**UK/EU:** Approved Document E. Rated to BS EN ISO 717.1.

**Fire AUS/NZ:** NCC Spec. C3.4. AS1530.4 & AS/NZS 1905.1. NZ BC Compliance Doc. C/AS1 6.19.2 & App. C6.1.1.

**UK/EU:** Approved Document B. BS EN 1634-1.

**FRL & FRR-/240/30.**

Gasket flammability index 1 when tested to AS1530.2.

**Smoke** NCC Spec. C3.4. AS1530.7 & BS EN 1634-3. Meets smoke leakage rates specified in AS6905 & EN 13501-2 "Sa", "Sm".

**Energy** NCC Pt. 3.12.3.3 & J3.4.

**Durability** Tested to over 1,000,000 operating cycles without failure.

**Patented, Registered Design.**

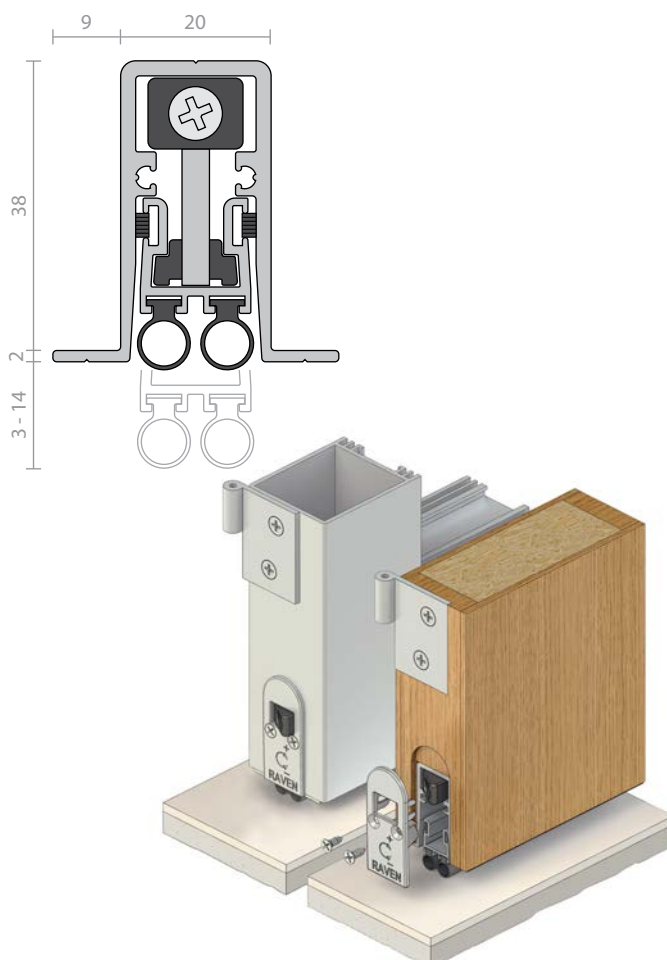

## RP128Si



An adjustable, automatic door bottom seal that is spring loaded to lift clear of the floor when the door is opened. Acoustically designed, featuring extruded silicon gaskets for medium temperature smoke applications, the RP128Si is operated automatically by pressure on the door stop by its adjustable strike. Utilising an aesthetic extruded aluminium cover for concealed fixing.

**Location:** Face mounted to the bottom of single and double solid core butt hinged doors. RP128Si can also be face mounted to the bottom of metal doors.

**Min/Max Gap:** 3mm to 14mm.

**Finish:** Satin clear (silver), black anodised aluminium (15µm) or paint at extra cost (page 7).

**Fixing:** Concealed screw fix. Zinc plated, cross recess head S.T. screws supplied. Colour matched escutcheon plates and face mount aluminium angle included.

**Seal:** RP3126Si. Black silicon rubber (SE).

**Sizes:** 1500mm, 1220mm, 1070mm, 920mm, 820mm, 600mm to 305mm (min). Seals cut back to exact size.

### Approvals

**UL** Cert. GVI.R37913

**Acoustic AUS/NZ:** NCC Spec. F5.5. UK/EU: Approved Document E. Rated to BS EN ISO 717.1.

**Fire AUS/NZ:** NCC Spec. C3.4. AS1530.4 & AS/NZS 1905.1. NZ BC Compliance Doc. C/AS1 6.19.2 & App. C6.1.1.

**FRL & FRR-/240/30.** Gasket flammability index 1 when tested to AS1530.2.

**Smoke** NCC Spec. C3.4. AS1530.7 & BS EN 1634-3. Meets smoke leakage rates specified in AS6905 & EN 13501-2 "Sa", "Sm".

**Energy** NCC Pt. 3.12.3.3 & J3.4.

**Durability** Tested to over 1,000,000 operating cycles without failure.

**Patented, Registered Design.**

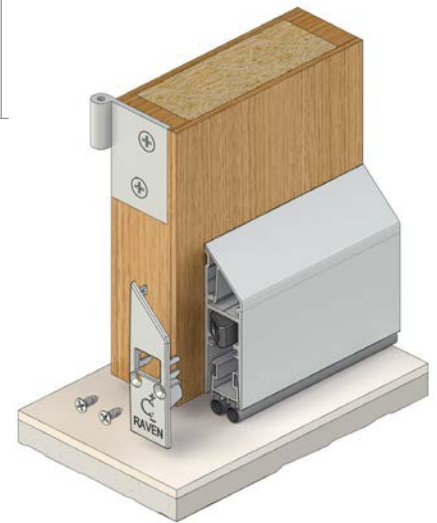
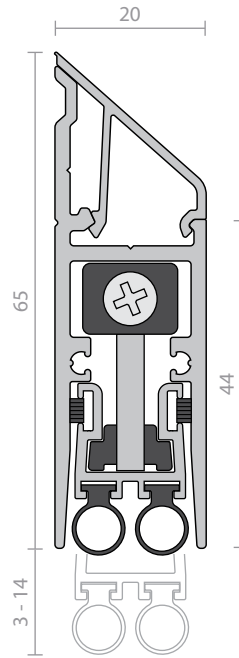

## RP4



A storm proof door bottom seal and threshold plate that is ideal where maximum weather protection is required. The RP4 multi-blade seal defies rain infiltration.

Can be fitted to the square cut bottom of a door without removing the door, provided there is an existing gap of 25mm. It is quick and easy to fit to both door and sill.

The sealing section is slotted for adjustment.

Also available as an intumescent fire and hot smoke seal. Refer to RP4FZ.

**Location:** Bottom of single and double butt hinged doors and sill.

**Min/Max Gap:** 23mm to 25mm.

**Finish:** Satin clear (silver), bronze or bright gold anodised aluminium (15µm) with anodised threshold plate (25µm).

**Fixing:** Concealed screw fix. Zinc plated, cross recess head S.T. screws and cover strip supplied. Fixing holes are pre-slotted. Threshold plate fixing holes are pre-punched and countersunk.

**Seal:** RP404, RP404a and RP404b. Grey PVC.

**Sizes:** Available in stock lengths.

### Approvals

**Access & Mobility NZ:** NZ BC Compliance Doc D1/AS1 1.3.2.

**UK/EU:** Approved Document M.

**Energy** NCC Pt. 3.12.3.3 & J3.4.

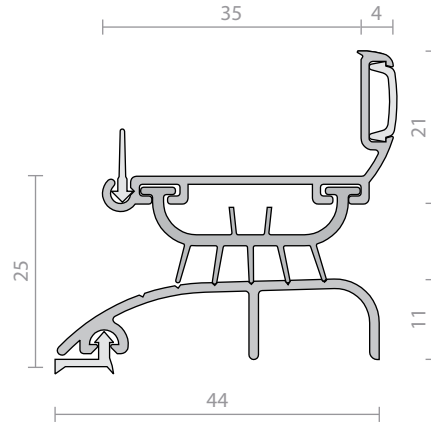

## RP4FZ



A storm proof door bottom seal and threshold plate that is ideal where maximum weather protection is required. The RP4FZ multi-blade seal defies rain infiltration. Can be fitted to the square cut bottom of a door without removing the door, provided there is an existing gap of 25mm.

With an intumescent fire seal providing protection to the bottom of the door in bushfire prone areas up to BAL FZ in accordance with AS3959.

**Location:** Bottom of single and double butt hinged doors and sill.

**Min/Max Gap:** 23mm to 25mm.

**Finish:** Satin clear (silver) or bronze anodised aluminium (15µm) with anodised threshold plate (25µm).

**Fixing:** Concealed screw fix. Zinc plated, cross recess head S.T. screws and cover strip supplied. Fixing holes are pre-slotted. Threshold plate fixing holes are pre-punched and countersunk.

**Seal:** RP404, RP404a and RP404b. Grey PVC.

**Sizes:** Available in stock lengths.

### Approvals

**Access & Mobility NZ:** NZ BC Compliance Doc D1/AS1 1.3.2.

**UK/EU:** Approved Document M.

**Energy** NCC Pt. 3.12.3.3 & J3.4.

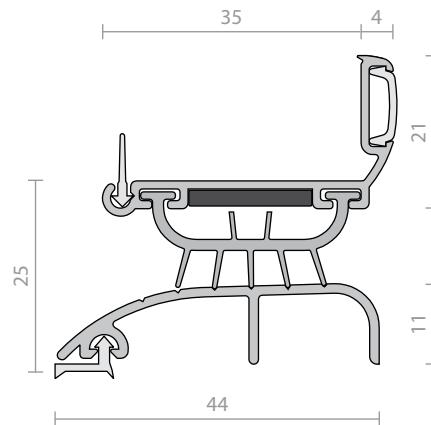

## RP4T



A weather seal, RP4T easily fits to the bottom of a door. It can be used in combination with threshold plates where even greater protection is required.

RP4T is particularly suitable for roll-up doors. Its fixings are concealed and its multi-blade seal defies rain infiltration.

Also available as an intumescent fire and hot smoke seal. Refer to RP114 for this feature.

**Location:** Roll-up doors. Single and double butt hinged doors or bulkhead applications.

**Min/Max Gap:** User determined.

**Finish:** Satin clear (silver), bronze anodised aluminium (15µm) or paint at extra cost (page 7).

**Fixing:** Concealed screw fix. Zinc plated, cross recess head S.T. screws and cover strip supplied. Fixing holes are pre-slotted.

**Seal:** RP404 and RP404b. Grey PVC.

**Sizes:** Available in stock lengths.

### Approvals

**Energy** NCC Pt. 3.12.3.3 & J3.4.

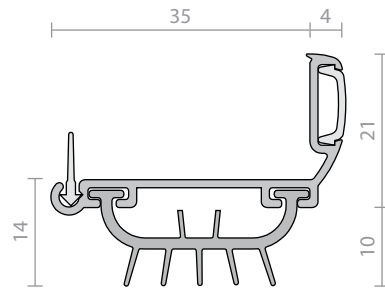

## RP114

p.98

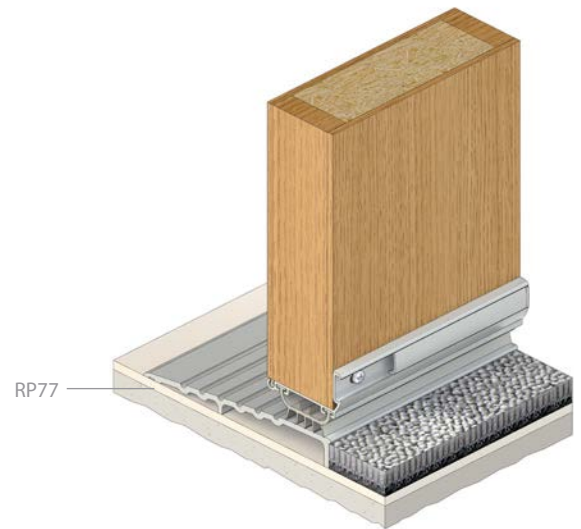
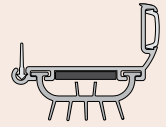

## RP5



A flexible EPDM weather strip sweep seal that fits to the bottom of doors. It is ideal for screen doors and sash windows to prevent insects from entering up the face of the glass. It is quick and easy to install to the door bottom, being fitted without removing the door. It is also ideal for garage tilt-up doors.

Can be used in conjunction with Raven RP13 and RP82 threshold plates.

**Location:** Bottom of doors, sash windows or around stiles of tilt up doors.

**Min/Max Gap:** Up to 15mm (user determined).

**Finish:** Satin clear (silver), bronze anodised aluminium (15µm) or paint at extra cost (page 7).

**Fixing:** Screw fix. Zinc plated, cross recess head S.T. screws supplied.

**Seal:** RP303. Black EPDM.

**Sizes:** Available in stock lengths.

### Approvals

**Fire** Gasket flammability index < 5 when tested to AS1530.2.

**Energy** NCC Pt. 3.12.3.3 & J3.4.

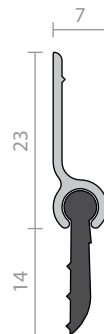

## RP17b



Co-extrusion (Adhesive backed).

A co-extruded PVC sweep seal that fits to the stiles or bottom of doors. These extremely flexible seals can be quick and easily installed without removing the door. Ideal for sliding and security screen doors.

Can be used in conjunction with Raven RP13 and RP82 threshold plates.

**Location:** Bottom of or around sliding or outward opening butt hinged doors.

**Min/Max Gap:** Up to 19mm (user determined).

**Fixing:** Self adhesive or can be screw fixed.

*Note: Contact surface must be clean, smooth and if painted, well cured. Self adhesive seals will not adhere to oiled or alkyd finishes or to easy clean wash and wear paint surfaces.*

**Seal:** White and grey or brown rigid and flexible PVC.

**Sizes:** Available in stock lengths.

### Approvals

**Energy** NCC Pt. 3.12.3.3 & J3.4.

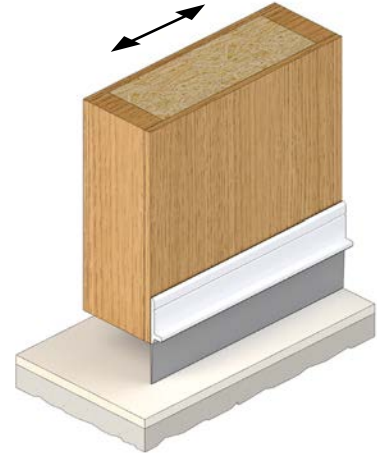
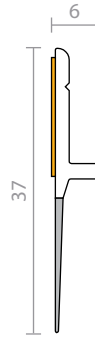

## RP26



A heavy duty sweep seal for door bottoms of outward opening doors. Slotted fixing holes allow for adjustment all concealed behind a push in cover strip.

The RP26 is ideal for use in conjunction with Raven threshold plates.

**Location:** Bottom of single and double, outward opening, butt hinged doors, tilt up doors or can be used as an astragal seal.

**Min/Max Gap:** 5mm to 20mm (user determined).

**Finish:** Satin clear (silver), bronze anodised aluminium (15µm) or paint at extra cost (page 7).

**Fixing:** Concealed screw fix. Zinc plated, cross recess head S.T. screws and cover strip supplied. Fixing holes are pre-slotted.

**Seal:** RP326. Black EPDM.

**Sizes:** Available in stock lengths.

### Approvals

**Fire AUS/NZ:** NCC Spec. C3.4. AS1530.4 & AS/NZS 1905.1.

**UK/EU:** Approved Document B. BS 476 Pt. 20 & 22 (similar to BS EN 1634-1).

**FRL & FRR-/120/30 and FD120.**

**Energy** NCC Pt. 3.12.3.3 & J3.4.

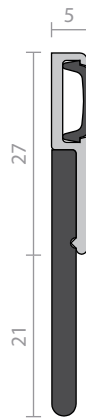

## RP30, RP31



The RP30 and RP31 are heavy duty sweep/compression seals. The RP30 is fitted into a concealed, machined groove that should be deep enough to allow packing for adjustment. Forms a weather seal when used with Raven RP13 or RP82 threshold plates.

The RP31 has greater compression than the RP30 and the design does not allow adjustment so it should not be installed in situations where adjustability is required. Forms a weather seal when used with Raven RP82 or RP115 threshold plates.

**Location:** Bottom of doors, meeting stiles or user determined bumper strip.

**Min/Max Gap:**

**RP30** 3mm to 8mm (user determined).

**RP31** 12mm to 17mm (user determined).

**Finish:** Satin clear (silver), bronze anodised aluminium (15µm) or paint at extra cost (page 7).

**Fixing:** Concealed screw fix. Zinc plated, cross recess head S.T. screws supplied.

**Seal:**

**RP30** RP330. Black EPDM.

**RP31** RP331. Black EPDM.

**Sizes:** Available in stock lengths.

**Approvals**

**Energy** NCC Pt. 3.12.3.3 & J3.4.

### RP30

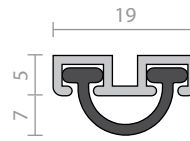

### RP31

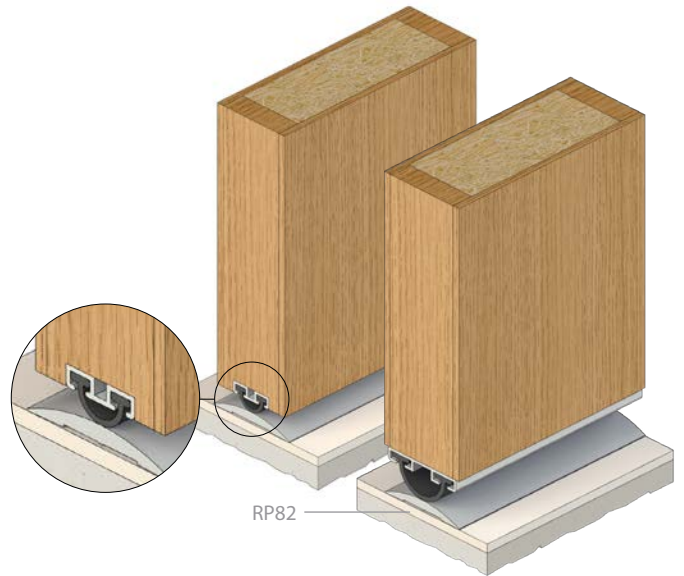
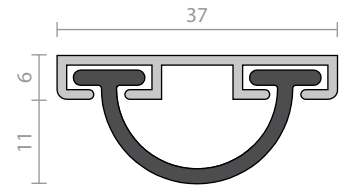

## RP51Si



A heavy duty silicon rubber sweep seal for the bottom of outward opening doors. RP51Si has slotted fixing holes for adjustment with a push-in cover strip for concealed fixing.

The RP51Si is ideal for use in conjunction with Raven threshold plates.

**Location:** Bottom of single and double, outward opening, butt hinged doors, tilt up doors or can be used as an astragal seal.

**Min/Max Gap:** 5mm to 20mm (user determined).

**Finish:** Satin clear (silver), bronze anodised aluminium (15µm) or paint at extra cost (page 7).

**Fixing:** Concealed screw fix. Zinc plated, cross recess head S.T. screws and cover strip supplied. Fixing holes are pre-slotted.

**Seal:** RP351Si. Grey silicon rubber (SE).

**Sizes:** Available in stock lengths.

**Approvals**

**Fire & Smoke AUS/NZ:** NCC Spec. C3.4. AS1530.4 & AS/NZS 1905.1. NZ BC Compliance Doc. C/AS1 6.19.2 & App. C6.1.1.

**UK/EU:** Approved Document B. BS 476 Pt. 20 & 22 (similar to BS EN 1634-1).

**FRL & FRR-120/30 and FD120.** Gasket flammability index 1 when tested to AS1530.2.

**Energy** NCC Pt. 3.12.3.3 & J3.4.

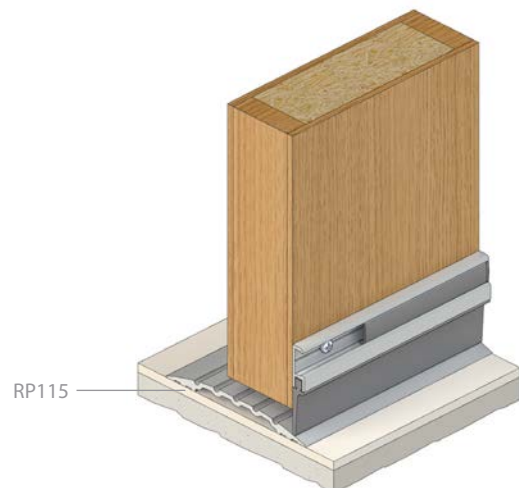
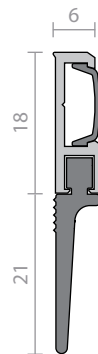

## RP54



A heavy duty storm proof weather seal ideal for residential and commercial applications where maximum weather protection is required. The RP54 (Daniels Patent) is a door bottom seal and threshold plate combination suitable for inward opening butt hinged doors.

Can be used in conjunction with Raven door frame or perimeter seals.

**Location:** Bottom of single and double inward opening butt hinged timber doors.

**Min/Max Gap:** 22mm to 25mm.

**Finish:** Satin clear (silver) or bronze anodised aluminium (25µm).

**Fixing:** Screw and nail fix. Zinc plated, cross recess head S.T. screws and zinc plated nails supplied.

**Seal:** RP354. Black EPDM. RP404a. Grey flexible PVC.

**Sizes:** Available in stock lengths.

### Approvals

**Access & Mobility NZ:** NZ BC Compliance Doc. D1/AS1 1.3.2.

**Energy** NCC Pt. 3.12.3.3 & J3.4.

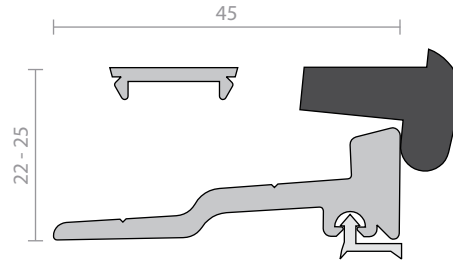

## RP81



A heavy duty EPDM sweep seal for door bottoms of outward opening doors with large gaps up to 120mm. Ideal for industrial sliding doors. This seal has slotted holes for adjustment with a push-in cover strip for concealment of fasteners.

The RP81 is ideal for use in conjunction with Raven threshold plates RP82 and RP29.

**Location:** Bottom of single and double outward opening doors or industrial sliding doors.

**Min/Max Gap:** Up to 120mm (seal can be slit to suit on site).

**Finish:** Satin clear (silver) anodised aluminium (15µm).

**Fixing:** Screw fix. Zinc plated, cross recess head S.T. screws supplied.

**Seal:** RP381. Black EPDM.

**Sizes:** Available in stock lengths.

### Approvals

**Energy** NCC Pt. 3.12.3.3 & J3.4.





## RP86



A weather proof door bottom seal, that is used by OEM joiners in situations where maximum weather protection is required. The multi-blade seal defies rain infiltration.

RP86 is fitted to the square cut bottom of a door, provided there is a gap of 19-20mm prior to installation (flat sill). It is quick and easy to fit to both door and sill.

RP86 can be fitted by builders, but is primarily designed for volume joinery fabrication.

**Location:** Bottom of single and double butt hinged timber doors.

**Min/Max Gap:** Flat sills: 19mm to 20mm. Rebated sills: 14mm to 15mm.

**Finish:** Satin clear (silver) or bronze anodised aluminium (15µm) with anodised threshold plate (25µm).

**Fixing:** Screw fix. Zinc plated, cross recess head S.T. screws supplied. Threshold plate fixing holes are pre-punched and countersunk.

**Seal:** RP486. Black or grey rigid and flexible UV stabilised PVC.

**Sizes:** 1000mm, 820mm. Threshold plate: 1660mm, 1000mm, 826mm.

### Approvals

**Access & Mobility NZ:** NZ BC Compliance Doc. D1/AS1 1.3.2. **UK/EU:** Approved Document M.

**Energy** NCC Pt. 3.12.3.3 & J3.4.

**Durability** Tested to over 1,000,000 operating cycles without failure.

**Registered Design.**

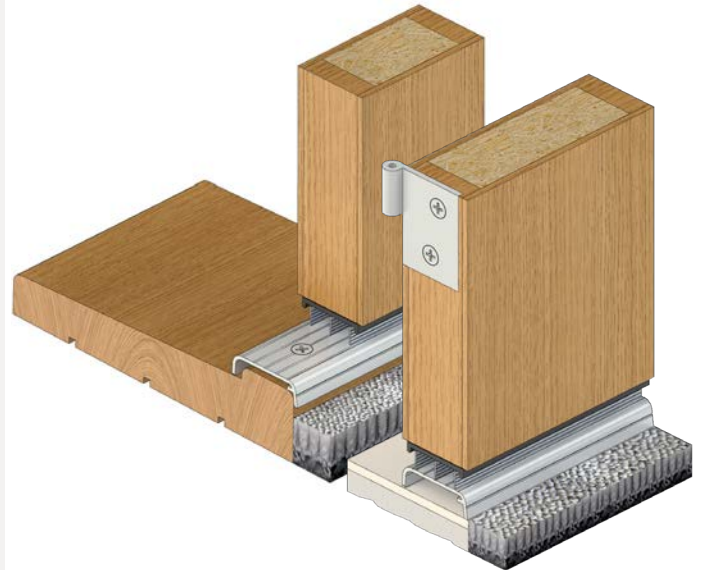
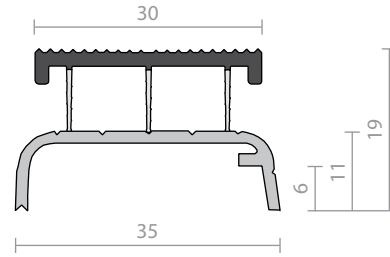

## RP89



A rigid and flexible co-polymer weather and energy seal. RP89 suits leading proprietary brand, hollow channel aluminium door suites. Concealed in the bottom of aluminium butt hinged doors or the bottom and head of pivot doors, RP89's unique design accommodates OEM and retrofit applications.

When used in conjunction with a Raven threshold plate an excellent weather and energy seal is achieved.

**Location:** Bottom or top of 40-45mm hollow channel aluminium doors. Suits butt hinged and pivot hinged systems. Sliding doors (user determined).

**Min/Max Gap:** 6mm to 9mm.

*Note: A Raven threshold plate is recommended to clear floor surface.*

**Fixing:** Snap fit design with end support lugs and screws supplied.

**Seal:** Black rigid and grey flexible UV stabilised co-polymer.

**Sizes:** 1000mm.

### Approvals

**Energy** NCC Pt. 3.12.3.3 & J3.4.

**Durability** Tested to over 500,000 operating cycles without failure.

**Registered Design.**

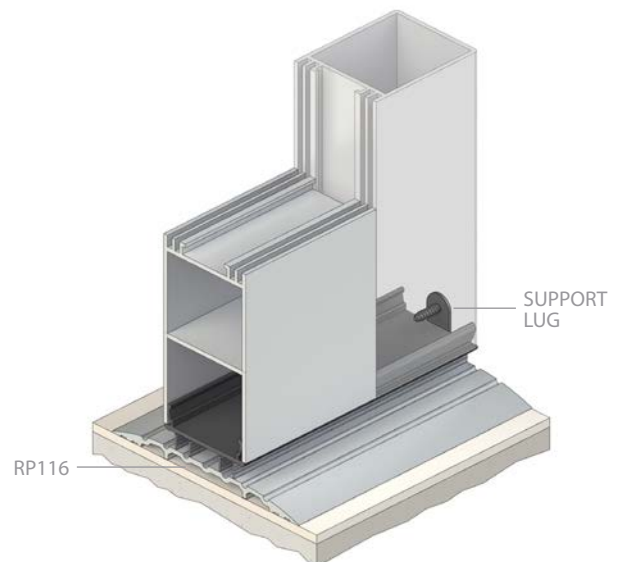
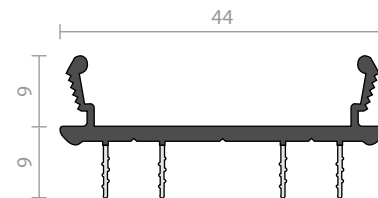

## RP123



RP123 is a co-polymer, door bottom weather seal with a concealed fix aluminium threshold plate. RP123 easily fits to the bottom of a door where maximum weather protection is required.

Quick and easy to install to both door and sill. RP123 is fitted to the square cut bottom of a door provided there is a gap of 19 - 20mm for a flat sill or 12 - 13mm for a rebated sill prior to installation.

**Location:** Bottom of single and double butt hinged doors with rebated or flat sills.

**Min/Max Gap:** Flat sill: 19mm to 20mm. Rebated sill: 12mm to 13mm.

**Finish:** Satin clear (silver) or bronze anodised aluminium (25µm) threshold plate.

**Fixing:** Concealed screw fix. Zinc plated, cross recess head S.T. screws and cover strip supplied. Fixing holes are pre-punched. Threshold plate can be screwed or fastened with builders adhesive for a concealed fix.

**Seal:** Light grey rigid PVC body with dark grey flexible PVC seal or, brown rigid PVC body with black flexible PVC seal.

**Sizes:** 1750mm, 926mm, 826mm.

### Approvals

**Access & Mobility NZ:** NZ BC Compliance Doc. D1/AS1 1.3.2.

**Energy:** NCC Pt. 3.12.3.3 & J3.4.

**Durability:** Tested to over 500,000 operating cycles without failure.

**Patented, Registered Design.**

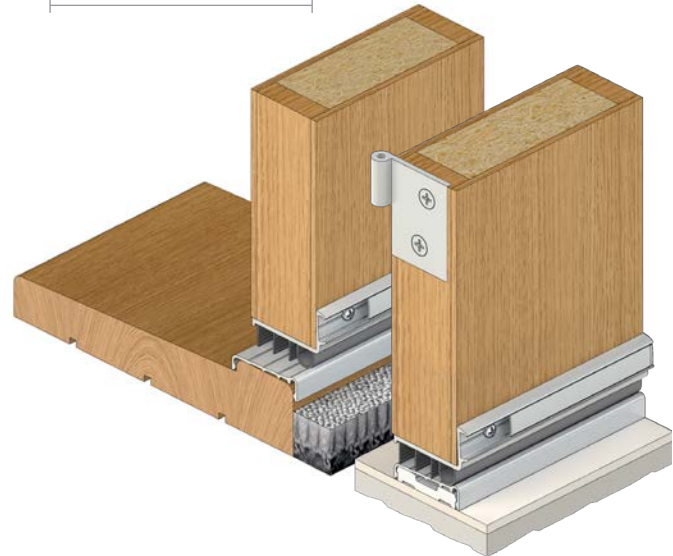
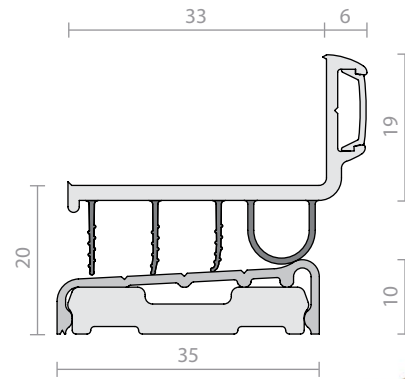

## RP129F



A heavy duty medium temperature smoke door bottom seal. The seal is achieved by a pair of nylon brush strips with a medium temperature smoke barrier.

The seal can be checked out or drilled to accommodate the pivot, thereby providing a continuous seal.

Can be used in conjunction with RP130Si, other Raven perimeter seals and threshold plates.

**Location:** Bottom of double butt hinged or centre pivot double acting doors.

**Min/Max Gap:** 15mm to 18mm.

**Finish:** Satin clear (silver) anodised aluminium (15µm) or paint at extra cost (page 7).

**Fixing:** Screw fix. Zinc plated, cross recess head S.T. screws supplied.

**Seal:** RP52F. Black fine and dense nylon filaments, UV stabilised medium temperature smoke barrier fin and galvanised steel spine.

**Sizes:** Available in stock lengths.

### Approvals

**Smoke:** NCC Spec. C3.4. NZ BC Compliance Doc. C/AS1 6.19.2(b). AS1530.7 & BS EN 1634-3 (similar to BS 476 section 31.1). Meets smoke leakage rates specified in AS6905 & EN 13501-2 "Sa", "Sm".

**Energy:** NCC Pt. 3.12.3.3 & J3.4.

**Durability:** Tested to over 1,000,000 operating cycles without failure.

**Patented, Registered Design.**

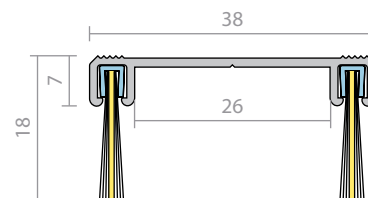

## RP129Si



A heavy duty medium temperature smoke and weather door bottom seal. The RP129Si can be checked out or drilled to accommodate pivot hardware whilst still providing a continuous seal.

Use in conjunction with RP130Si and a Raven threshold plate (essential).

**Location:** Bottom of double butt hinged or centre pivot double acting doors.

**Min/Max Gap:** 14mm to 18mm.

**Finish:** Satin clear (silver) anodised aluminium (15µm) or paint at extra cost (page 7).

**Fixing:** Screw fix. Zinc plated, cross recess head S.T. screws supplied.

**Seal:** RP3129Si. Light grey silicon rubber (SE).

**Sizes:** Available in stock lengths.

### Approvals

**Fire** Gasket flammability index 1 when tested to AS1530.2.

**Smoke** NCC Spec. C3.4. NZ BC Compliance Doc. C/AS1 6.19.2(b). AS1530.7 & BS EN 1634-3 (similar to BS 476 section 31.1). Meets smoke leakage rates specified in AS6905 & EN 13501-2 "Sa", "Sm".

**Energy** NCC Pt. 3.12.3.3 & J3.4.

**Durability** Tested to over 1,000,000 operating cycles without failure.

**Registered Design.**

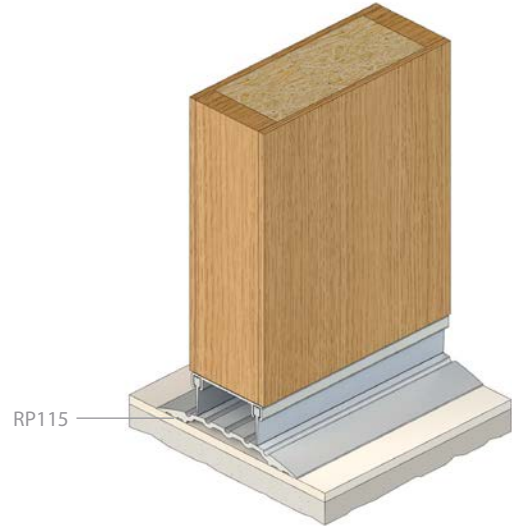
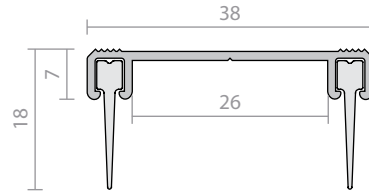

## Brush Strip Seals

### RP2, RP2b (brush only) p.101

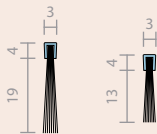

### RP2a p.102

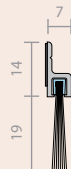

### RP2b p.102

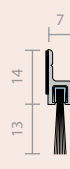

### RP15 p.103

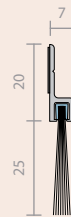

### RP41 p.103

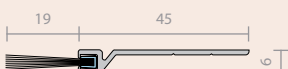

### RP49, RP50 p.104

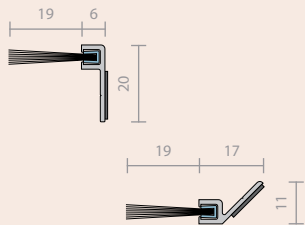

### RP51F p.104

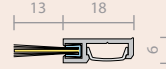

### RP52F p.105



### RP57, RP58 p.105

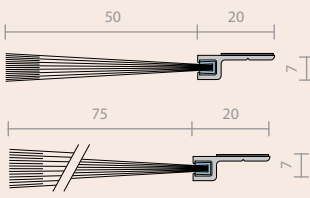

### RP74 p.106



### RP74F p.106

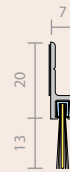

### RP75 p.107

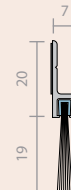



## Threshold Plate Seals

Threshold plate seals incorporate a seal bulb in the threshold plate itself and as such the addition of a door bottom seal may not be required. Threshold plates offer a simple and effective sealing solution for the door bottom of outward opening doors.

Threshold plate seals are ideal for use with door frame perimeter seals and astragal seals which create a continuous seal or Bulk head seal around the doorway which offers maximum sealing protection.

Threshold plate seals can also accommodate a panic type exit device or panic bolt (by others) while giving added security at the bottom of the door.

## RP97Si



A threshold plate seal best suited for outward opening butt hinged doors. When used in conjunction with RP93Si and RP16Si an excellent smoke and acoustic system is achieved. For acoustic applications the void under the RP97Si should be filled with sound foam or other suitable material (by others). Conforms to NCC Pt. D2.15 Thresholds (a), (b), (c).

The RP67 drip strip should be considered for above the doorway if there is no eave.

Ideal for use in conjunction with the RP93Si perimeter seal and Raven astragals.

**Location:** Door sills abutting outward opening butt hinged doors. Not recommended for pedestrian entry doors.

**Min/Max Gap:** Compression 0mm to 2mm.

**Finish:** Satin clear (silver) anodised aluminium (25µm).

**Fixing:** Screw fix or builders adhesive for concealed fixing (user determined). Zinc plated, cross recess head CSK S.T. screws supplied.

**Seal:** RP393Si. Black silicon rubber (SE).

**Sizes:** Available in stock lengths. Specify longer length than doorway to allow for neat installation around door frame.

### Approvals

Cert. G.VYI.R37913

**Access & Mobility AUS/NZ:** NCC Pt. D2.15 thresholds (a),(b),(c). NZ BC Compliance Doc. D1/AS1 1.3.2.

**Acoustic AUS/NZ:** NCC Spec. F5.5. **UK/EU:** Approved Document E. Rated to BS EN ISO 717.1.

**Fire & Smoke AUS/NZ:** NCC Spec. C3.4. NZ BC Compliance Doc. C/AS1 6.19.2 & App. C6.1.1.

**UK/EU:** Approved Document B.

**FRL & FRR-/240/30.**

Gasket flammability index 1 when tested to AS1530.2.

**BAL ≤FZ** when used with a BAL rated door bottom seal in accordance with AS3959.

**Energy** NCC Pt. 3.12.3.3 & J3.4.

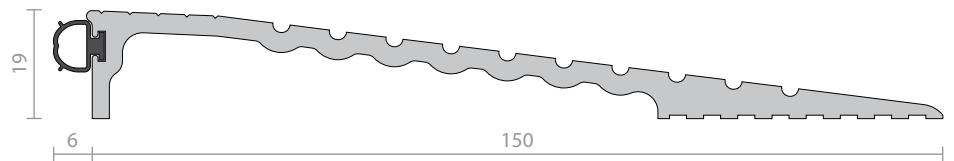
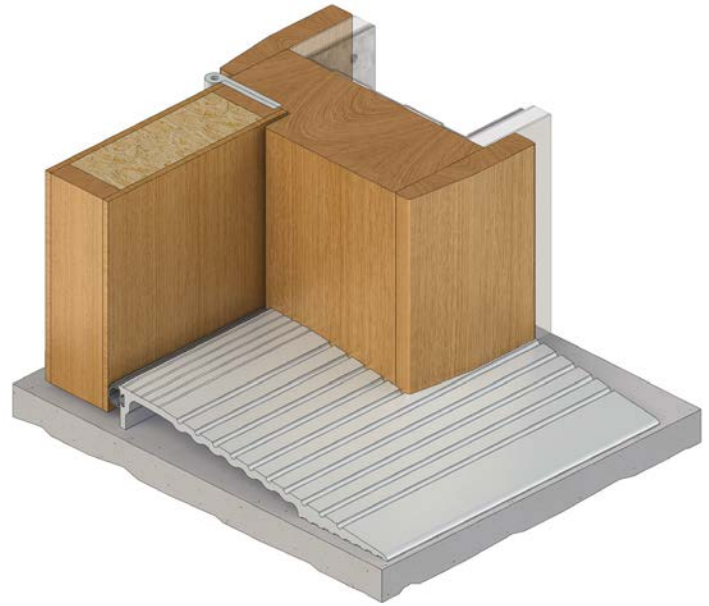

Not to scale

## RP109Si



The RP109Si is a weather proof threshold plate seal suited to outward opening butt hinged doors. It is ideal for use with a panic type exit device (by others).

For acoustic applications the void under the threshold should be filled with sound foam or other suitable material (by others).

The RP67 drip strip should be considered for above the doorway if there is no eave.

Ideal for use in conjunction with the RP93Si perimeter seal and Raven astragals.

**Location:** Door sill of outward opening doors (butt hinges recommended).

**Min/Max Gap:** Compression 0mm to 2mm.

**Finish:** Satin clear (silver) anodised aluminium (25µm).

**Fixing:** Screw fix or builders adhesive for concealed fixing (user determined). Zinc plated, cross recess head CSK S.T. screws supplied.

**Seal:** RP393Si. Black silicon rubber (SE).

**Sizes:** Available in stock lengths.

### Approvals

Cert. G.VYI.R37913

**Acoustic AUS/NZ:** NCC Spec. F5.5. **UK/EU:** Approved Document E. Rated to BS EN ISO 717.1.

**Fire & Smoke AUS/NZ:** NCC Spec. C3.4. NZ BC Compliance Doc. C/AS1 6.19.2 & App. C6.1.1.

**FRL & FRR-/240/30.**

Gasket flammability index 1 when tested to AS1530.2.

**BAL ≤FZ** when used with a BAL rated door bottom seal in accordance with AS 3959.

**Energy** NCC Pt. 3.12.3.3 & J3.4.

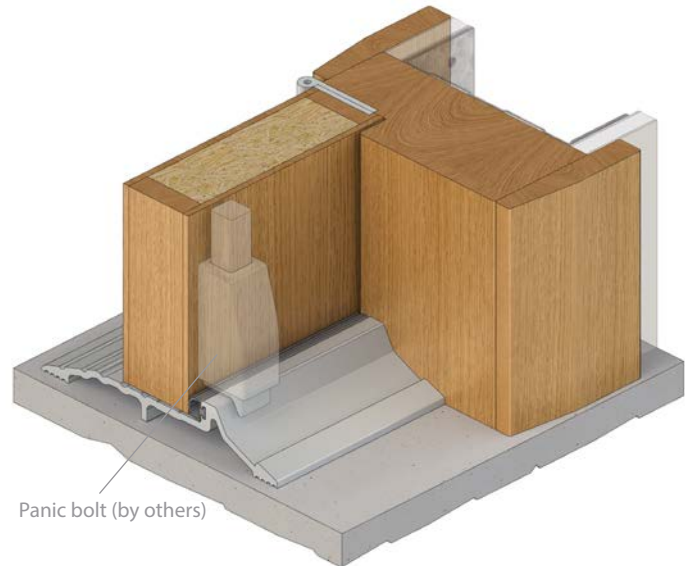

Panic bolt (by others)

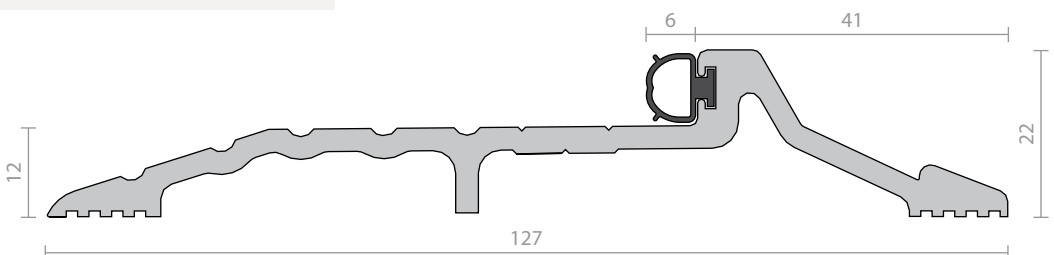

Door Bottom Seals

## RP110Si



The RP110Si is a weather proof threshold plate seal suited to outward opening butt hinged doors. It is ideal for use with a panic type exit device (by others).

For acoustic applications the void under the threshold should be filled with sound foam or other suitable material (by others).

The RP67 drip strip should be considered for above the doorway if there is no eave.

Ideal for use in conjunction with the Raven RP93Si perimeter seal and Raven astragals.

**Location:** Door sill of outward opening doors. (butt hinges recommended).

**Min/Max Gap:** Compression 0mm to 2mm.

**Finish:** Satin clear (silver) anodised aluminium (25µm).

**Fixing:** Screw fix or builders adhesive for concealed fixing (user determined). Zinc plated, cross recess head CSK S.T. screws supplied.

**Seal:** RP393Si. Black silicon rubber (SE).

**Sizes:** Available in stock lengths.

### Approvals

UL Cert. GVV1.R37913

**Acoustic AUS/NZ:** NCC Spec. F5.5.  
**UK/EU:** Approved Document E. Rated to BS EN ISO 717.1.

**Fire & Smoke AUS/NZ:** NCC Spec. C3.4. NZ BC Compliance Doc. C/AS1 6.19.2 & App. C6.1.1.

**FRL & FRR-/240/30.**

Gasket flammability index 1 when tested to AS1530.2.

**BAL** **≤FZ** when used with a BAL rated door bottom seal in accordance with AS 3959.

**Energy** NCC Pt. 3.12.3.3 & J3.4.

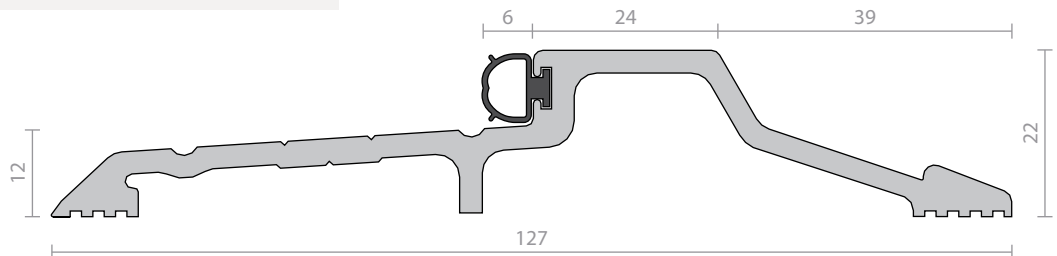
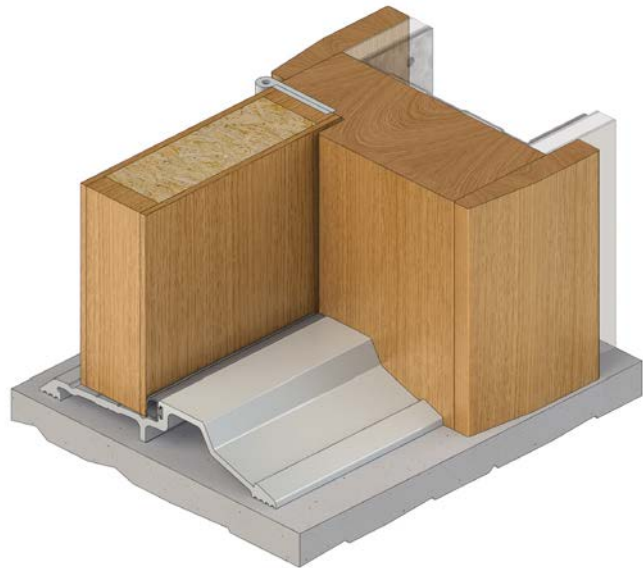

## RP111Si



The RP111Si is a weather proof threshold plate seal suited to outward opening butt hinged doors. It is ideal for use with a panic type exit device (by others).

For acoustic applications the void under the threshold should be filled with sound foam or other suitable material (by others).

The RP67 drip strip should be considered for above the doorway if there is no eave.

Ideal for use in conjunction with the Raven RP93Si perimeter seal and Raven astragals.

**Location:** Door sill of outward opening doors. (butt hinges recommended).

**Min/Max Gap:** Compression 0mm to 2mm.

**Finish:** Satin clear (silver) anodised aluminium (25µm).

**Fixing:** Screw fix or builders adhesive for concealed fixing (user determined). Zinc plated, cross recess head CSK S.T. screws supplied.

**Seal:** RP393Si. Black silicon rubber (SE).

**Sizes:** Available in stock lengths.

### Approvals

UL Cert. GVV1.R37913

ANSI/BHMA A156.22

**Access & Mobility NZ:** NZ BC Compliance Doc. D1/AS1 1.3.2.

**Acoustic AUS/NZ:** NCC Spec. F5.5.  
**UK/EU:** Approved Document E. Rated to BS EN ISO 717.1.

**Fire & Smoke AUS/NZ:** NCC Spec. C3.4. NZ BC Compliance Doc. C/AS1 6.19.2 & App. C6.1.1.

**FRL & FRR-/240/30.**

Gasket flammability index 1 when tested to AS1530.2.

**BAL** **≤FZ** when used with a BAL rated door bottom seal in accordance with AS 3959.

**Energy** NCC Pt. 3.12.3.3 & J3.4.

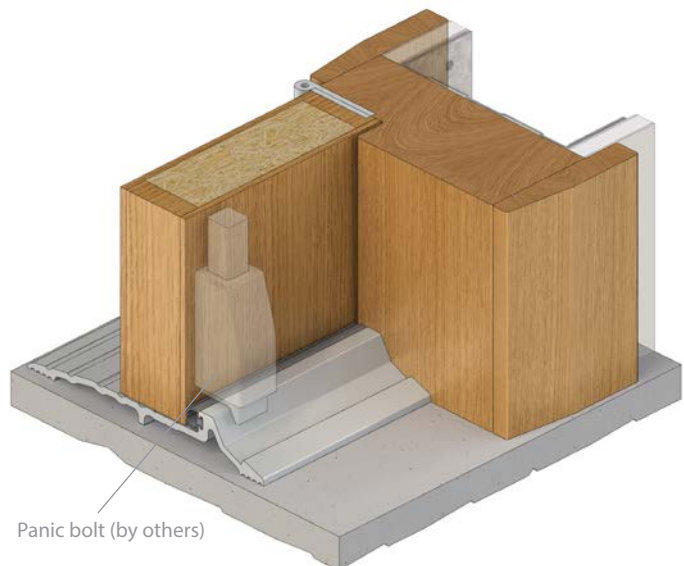

Panic bolt (by others)

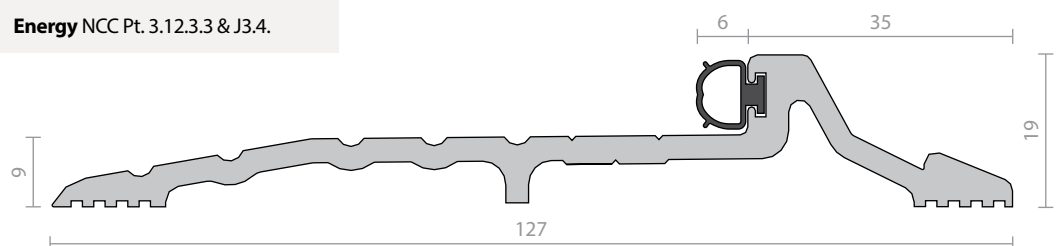

## RP117Si



The RP117Si is a weather proof threshold plate seal suited to outward opening butt hinged doors. It is ideal for use with a panic type exit device (by others).

For acoustic applications the void under the threshold should be filled with sound foam or other suitable material (by others).

The RP67 drip strip should be considered for above the doorway if there is no eave.

Ideal for use in conjunction with the Raven RP118Si perimeter seal and Raven astragals.

**Location:** Door sill of outward opening doors. (butt hinges recommended).

**Min/Max Gap:** Compression 0mm to 2mm.

**Finish:** Satin clear (silver) anodised aluminium (25µm).

**Fixing:** Screw fix or builders adhesive for concealed fixing (user determined). Zinc plated, cross recess head CSK S.T. screws supplied.

**Seal:** RP308Si. Grey silicon rubber (SE).

**Sizes:** Available in stock lengths.

### Approvals

Cert. GVYL.R37913

**Access & Mobility NZ:** NZ BC Compliance Doc. D1/AS1 1.3.2. **UK/EU:** Approved Document M.

**Acoustic AUS/NZ:** NCC Spec. F5.5. **UK/EU:** Approved Document E. Rated to BS EN ISO 717.1.

**Fire & Smoke AUS/NZ:** NCC Spec. C3.4. NZ BC Compliance Doc. C/AS1 6.19.2 & App. C6.1.1.

**UK/EU:** Approved Document B.

**FRL & FRR-/240/30.** Gasket flammability index 1 when tested to AS1530.2.

**BAL ≤FZ** when used with a BAL rated door bottom seal in accordance with AS 3959.

**Energy** NCC Pt. 3.12.3.3 & J3.4.

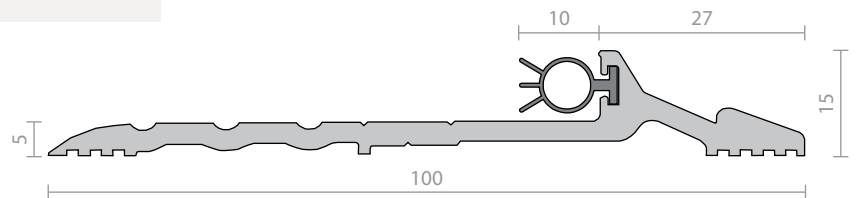
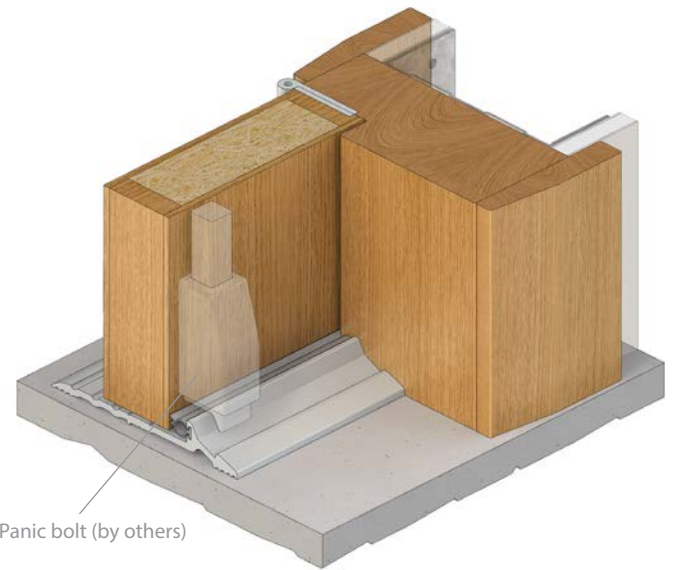

## Raven Meets The Challenge

The South Australian Health and Medical Research Institute (SAHMRI) is South Australia's first independent, flagship health and medical research institute and the pioneer of the state's new Health and Biomedical Precinct.

Raven, the industry leader of door and window sealing systems, were sought to meet the sealing challenges of this iconic building which will house 600 local, interstate and international researchers.

Raven seals were required to perform across multiple levels from the exclusion of weather through to acoustic attenuation and the containment of energy. Raven's tested and certified sealing systems were chosen due to the high level of compliance and certification requirements along with Raven's flexibility to meet the building's bespoke requirements.

Raven developed a perimeter seal for the SAHMRI project which included smooth sealing bulbs for easy cleaning and fully adjustable fixing components that ensures an optimum seal at all times.



## Threshold Plates

Threshold plates are hard anodised, aluminium extrusions that are fitted to the sill under doors; they provide a clean delineation between adjacent floor surfaces. A weather barrier in themselves, threshold plates provide an optimum sealing surface for door bottom seals. Being hard wearing, threshold plates offer an elevated sealing surface which, in the case of door bottom sweep seals, prevents contact or excessive resistance over carpeted or uneven floors.

Raven threshold plates have been designed to withstand the day to day rigours of heavy pedestrian and wheeled traffic encountered in commercial buildings. Their low profile designs do not impede wheeled traffic nor do they present a tripping hazard for pedestrian traffic.

Where disabled access is a requirement, ensure that the threshold plate is suitable for wheeled access and that it conforms to the relevant building code or standard. To assist with selection, a wheelchair icon  is shown including the approvals description.



## RP4b



A medium duty threshold plate with integral sill gasket for use in conjunction with Raven door bottom seals.

**Location:** Door sill.

**Finish:** Satin clear (silver) or bronze anodised aluminium (25µm).

**Fixing:** Screw fix. Zinc plated, cross recess head CSK S.T. screws supplied. Fixing holes are pre-punched and countersunk.

**Seal:** RP404a. Grey flexible PVC.

**Sizes:** Available in stock lengths.

### Approvals

**Access & Mobility NZ:** NZ BC Compliance Doc. D1/AS1 1.3.2.   
**UK/EU:** Approved Document M.

**Fire AUS/NZ:** NCC Spec. C3.4. AS1530.4 & AS/NZS 1905.1. NZ BC Compliance Doc. C/AS1 6.19.2(a) & App. C6.1.1.

**UK/EU:** Approved Document B. BS 476 Pt. 20 & 22 (similar to BS EN 1634-1).

**FRL & FRR-/240/30.**

**BAL ≤FZ** when used with a BAL rated door bottom seal in accordance with AS 3959.

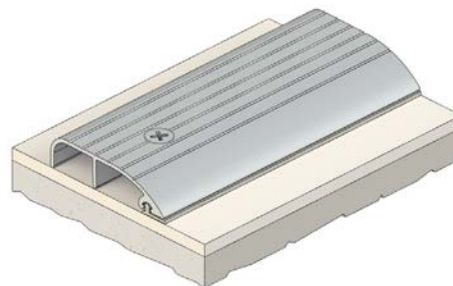
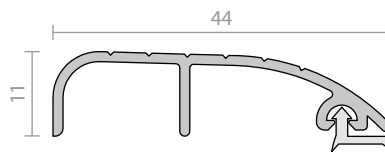

## RP13, RP82



Low profile threshold plates that are ideal for use in conjunction with Raven door bottom seals to prevent rain, draughts, noise and smoke infiltration.

**Location:** Door sill.

**Finish:** Satin clear (silver) or bronze anodised aluminium (25µm).

**Fixing:** Screw fix or builders adhesive for concealed fixing (user determined). Colour matched zinc plated, cross recess head CSK S.T. screws supplied.

**Sizes:** Available in stock lengths.

### Approvals

Cert. GVI.R37913

**Access & Mobility AUS/NZ:** NCC D2.15 & D3.3. AS1428.1. NZ BC Compliance Doc. D1/AS1 1.3.2.   
**UK/EU:** Approved Document M.

**Fire AUS/NZ:** NCC Spec. C3.4. AS1530.4 & AS/NZS 1905.1. NZ BC Compliance Doc. C/AS1 6.19.2(a) & App. C6.1.1.

**UK/EU:** Approved Document B. BS 476 Pt. 20 & 22 (similar to BS EN 1634-1).

**FRL & FRR-/240/30.**

**BAL ≤FZ** when used with a BAL rated door bottom seal in accordance with AS 3959.

### RP13

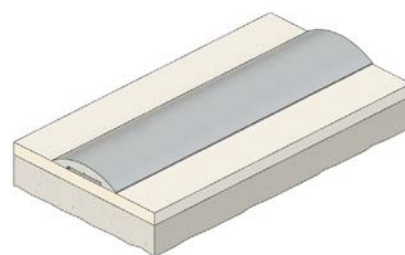
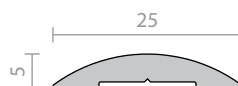

### RP82

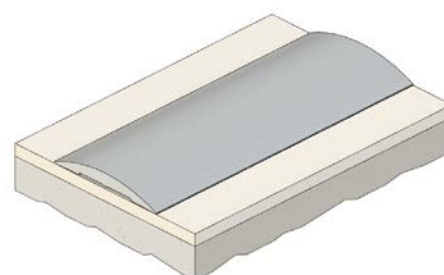
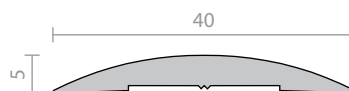

## RP18



A heavy duty threshold plate designed for butt hinged, single, double, or pivot hinge doors. It allows the door leaf to clear high pile carpets which have been laid up to the frame. It has been designed to accommodate concealed screw fixings through the door jambs.

An aluminium door frame, complete with the threshold plate, can be assembled by a door fabricator prior to transporting as a complete unit. RP18 will accommodate Pivot Sets for most types of Transom Closers.

Used in Conjunction with Raven door bottom seals RP2b and RP74 (RP8Si butt hinged doors).

**Location:** Door sill of single, double butt hinged or pivot hinged doors.

**Finish:** Satin clear (silver) or bronze anodised aluminium (25µm).

**Fixing:** By door fabricator.

**Sizes:** Available in stock lengths.

### Approvals

Cert. GVV1.R37913

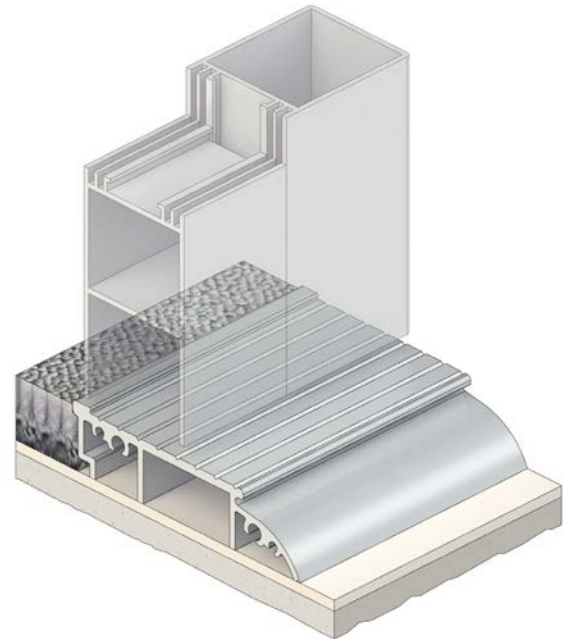
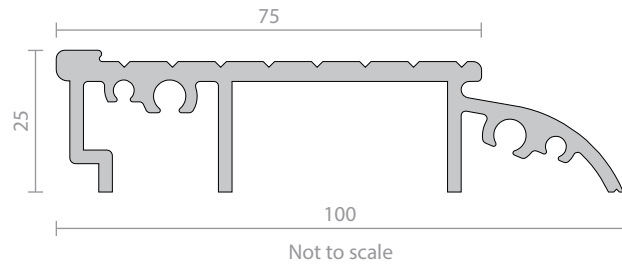

## RP19



A heavy duty threshold plate with ribbed profile and integral sill gaskets.

Can be used in conjunction with Raven door bottom seals to prevent rain, draughts, noise and smoke infiltration.

RP19 has been designed to accommodate a concealed screw fix through the door jambs.

**Location:** Door sill.

**Finish:** Satin clear (silver) or bronze anodised aluminium (25µm).

**Fixing:** Screw fix. Colour matched zinc plated, cross recess head CSK S.T. screws supplied.

**Seal:** RP404a. Grey flexible PVC.

**Sizes:** Available in stock lengths.

### Approvals

**Access & Mobility NZ:** NZ BC Compliance Doc. D1/AS1 1.3.2.

**UK/EU:** Approved Document M.

**Fire AUS/NZ:** NCC Spec. C3.4. AS1530.4 & AS/NZS 1905.1. NZ BC Compliance Doc. C/AS1 6.19.2(a) & App. C6.1.1.

**UK/EU:** Approved Document B. BS 476 Pt. 20 & 22 (similar to BS EN 1634-1).

**FRL & FRR-/240/30.**

**BAL ≤FZ** when used with a BAL rated door bottom seal in accordance with AS 3959.

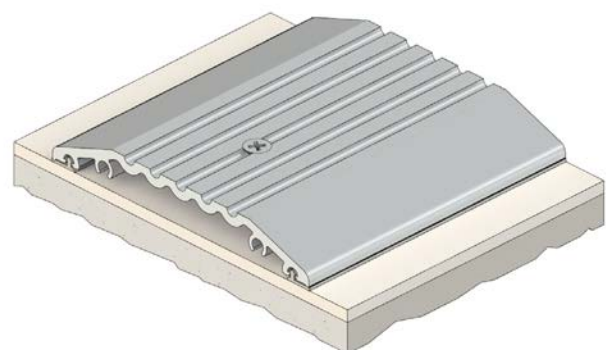
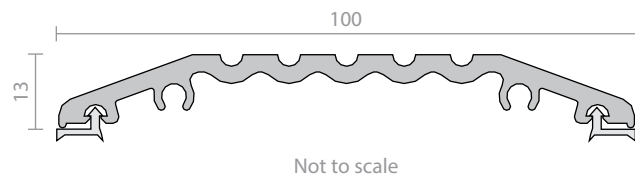

## RP27



A heavy duty threshold plate designed for sill and carpet edge protection.

Can be used in conjunction with Raven door bottom seals to prevent rain, draughts, noise and smoke infiltration.

**Location:** Door sill.

**Finish:** Satin clear (silver) or bronze anodised aluminium (25µm).

**Fixing:** Screw fix. Colour matched zinc plated, cross recess head CSK S.T. screws supplied.

**Sizes:** Available in stock lengths.

### Approvals

**Access & Mobility NZ:** NZ BC Compliance Doc. D1/AS1 1.3.2.   
**UK/EU:** Approved Document M.

**Fire AUS/NZ:** NCC Spec. C3.4. AS1530.4 & AS/NZS 1905.1. NZ BC Compliance Doc. C/AS1 6.19.2(a) & App. C6.1.1.

**UK/EU:** Approved Document B. BS 476 Pt. 20 & 22 (similar to BS EN 1634-1).

**FRL & FRR-/240/30.**

**BAL ≤FZ** when used with a BAL rated door bottom seal in accordance with AS 3959.

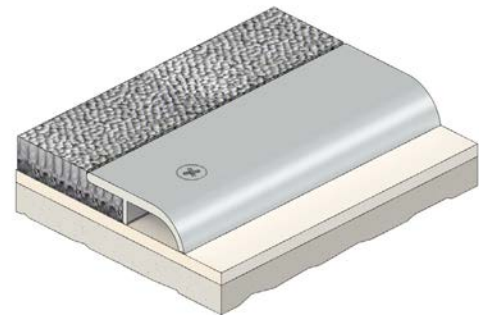
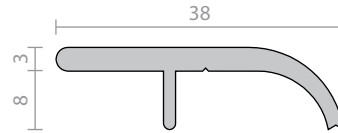

## RP28, RP29



RP28 and RP29 are wide, heavy duty threshold plates with ribbed profiles and integral sill gaskets. They are ideal for use with pivot hinge doors.

Can be used in conjunction with Raven door bottom seals to prevent rain, draughts, noise and smoke infiltration.

**Location:** Door sill.

**Finish:** Satin clear (silver) or bronze anodised aluminium (25µm).

**Fixing:** Screw fix. Colour matched zinc plated, cross recess head CSK S.T. screws supplied.

**Seal:** RP404a. Grey flexible PVC.

**Sizes:** Available in stock lengths.

### Approvals

**Access & Mobility NZ:** NZ BC Compliance Doc. D1/AS1 1.3.2.   
**UK/EU:** Approved Document M.

**Fire AUS/NZ:** NCC Spec. C3.4. AS1530.4 & AS/NZS 1905.1. NZ BC Compliance Doc. C/AS1 6.19.2(a) & App. C6.1.1.

**UK/EU:** Approved Document B. BS 476 Pt. 20 & 22 (similar to BS EN 1634-1).

**FRL & FRR-/240/30 and FD120.**

**BAL ≤FZ** when used with a BAL rated door bottom seal in accordance with AS 3959.

## RP28

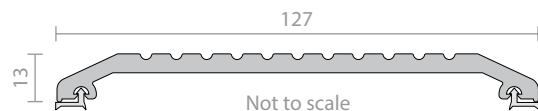

## RP29

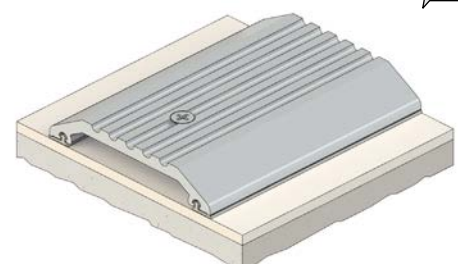
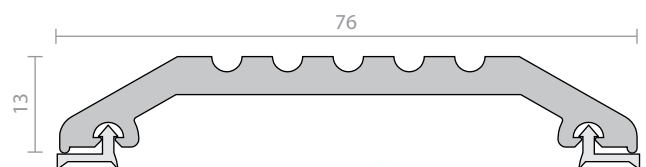

## RP66



A flush fitting threshold plate designed for use on internal doors with carpeted floors. The RP66 can be used in conjunction with Raven door bottom seals such as the RP38Si to provide an optimum sealing surface as carpets can flatten and thus reduce sealing effectiveness. RP66 has concealed fixings with self adhesive aluminium insert.

**Location:** Door sill of internal doors with carpeted sills.

**Finish:** Satin clear (silver) anodised aluminium (25µm).

**Fixing:** Screw fix with self adhesive insert. Zinc plated, cross recess head CSK S.T. screws supplied.

**Sizes:** Available in stock lengths.

### Approvals

**Access & Mobility AUS/NZ:** NCC D2.15 & D3.3. AS1428.1. NZ BC Compliance Doc. D1/AS1 1.3.2.

**UK/EU:** Approved Document M.

**Fire AUS/NZ:** NCC Spec. C3.4. AS1530.4 & AS/NZS 1905.1. NZ BC Compliance Doc. C/AS1 6.19.2(a) & App. C6.1.1.

**UK/EU:** Approved Document B. BS 476 Pt. 20 & 22 (similar to BS EN 1634-1).

**FRL & FRR-/240/30.**

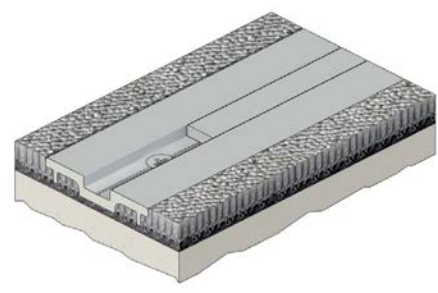
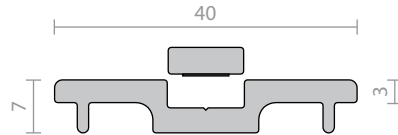

## RP77, RP98



Heavy duty threshold ramps with a ribbed design which can be positioned back to back to form a two way threshold ramp conforming to NCC Pt. D2.15 Thresholds (b).

The RP77 and RP98 can be used in conjunction with Raven door bottom seals to prevent rain, draughts, noise and smoke infiltration. Suitable for use with most floor pivots.

Ideal for commercial shop fronts providing a neat ramp detail between carpets or tiles at door ways.

Can also be used to provide a ramped frame for internal door mats.

**Location:** Door sill.

**Finish:** Satin clear (silver) anodised aluminium (25µm).

**Fixing:** Screw fix. Zinc plated, cross recess head CSK S.T. screws supplied.

**RP98** Can be fastened with builders adhesive for concealed fixing.

**Sizes:** Available in stock lengths. Specify longer length than doorway to allow for neat installation around door frame.

### Approvals

Cert. GVI1.R37913

**Access & Mobility AUS/NZ:** NCC D2.15 & D3.3. AS1428.1. NZ BC Compliance Doc. D1/AS1 1.3.2.

**UK/EU:** Approved Document M.

**Fire AUS/NZ:** NCC Spec. C3.4. AS1530.4 & AS/NZS 1905.1. NZ BC Compliance Doc. C/AS1 6.19.2(a) & App. C6.1.1.

**UK/EU:** Approved Document B. BS 476 Pt. 20 & 22 (similar to BS EN 1634-1).

**FRL & FRR-/240/30.**

**BAL ≤FZ** when used with a BAL rated door bottom seal in accordance with AS 3959.

### RP77

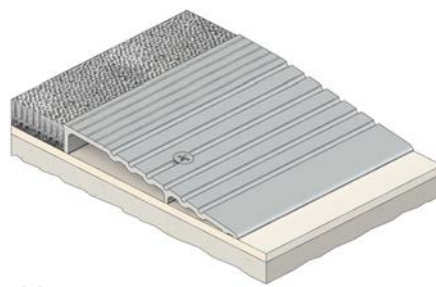
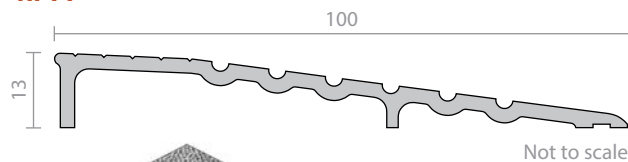

### RP98

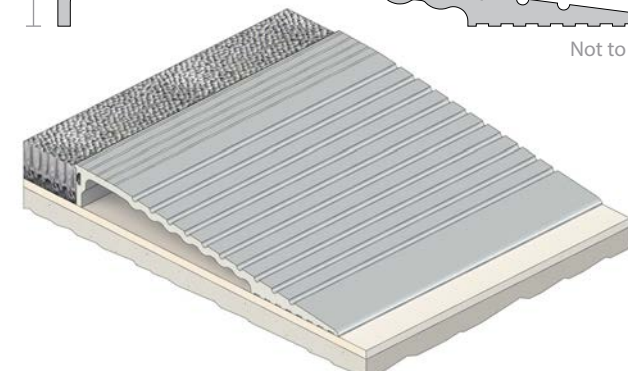
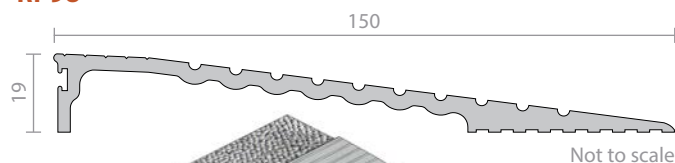

## RP91



A heavy duty threshold plate with integral sill gasket that can be used in conjunction with Raven door bottom seals on roll-up and tilt up doors.

RP91 has an upstand to prevent water penetration and a ramped section to shed water away.

**Location:** Door sill.

**Finish:** Satin clear (silver) anodised aluminium (25µm).

**Fixing:** Screw fix. Colour matched zinc plated, cross recess head CSK S.T. screws supplied.

**Seal:** RP404a. Grey flexible PVC.

**Sizes:** Available in stock lengths.

### Approvals

**Access & Mobility NZ:** NZ BC Compliance Doc. D1 Pt. 1.3.2.

**Fire AUS/NZ:** NCC Spec. C3.4. AS1530.4 & AS/NZS 1905.1. NZ BC Compliance Doc. C/AS1 6.19.2(a) & App. C6.1.1.

**UK/EU:** Approved Document B. Approved to BS 476 Pt. 20 & 22 (similar to BS EN 1634-1).

**FRL & FRR-/240/30.**   
BAL  $\leq$  **FZ** when used with a BAL rated door bottom seal in accordance with AS 3959.

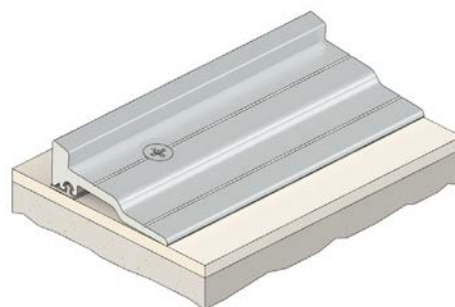
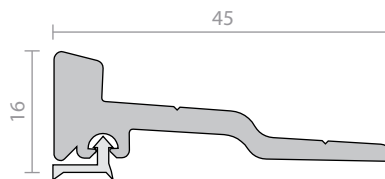

## RP95, RP96



Low profile threshold plates that can be used in conjunction with Raven door bottom seals to prevent rain, draught, noise and smoke infiltration.

**Location:** Door sill.

**Finish:** Satin clear (silver) or bronze anodised aluminium (25µm).

**Fixing:** Screw fix or builders adhesive for concealed fixing (user determined). Colour matched zinc plated, cross recess head CSK S.T. screws supplied.

**Sizes:** Available in stock lengths.

### Approvals

Cert. GVI.R37913

**Access & Mobility AUS/NZ:** NCC D2.15 & D3.3. AS1428.1. NZ BC Compliance Doc. D1/AS1 1.3.2.

**UK/EU:** Approved Document M.

**Fire AUS/NZ:** NCC Spec. C3.4. AS1530.4 & AS/NZS 1905.1. NZ BC Compliance Doc. C/AS1 6.19.2(a) & App. C6.1.1.

**UK/EU:** Approved Document B. BS 476 Pt. 20 & 22 (similar to BS EN 1634-1).

**FRL & FRR-/240/30 and FD240.**   
BAL  $\leq$  **FZ** when used with a BAL rated door bottom seal in accordance with AS 3959.

### RP95

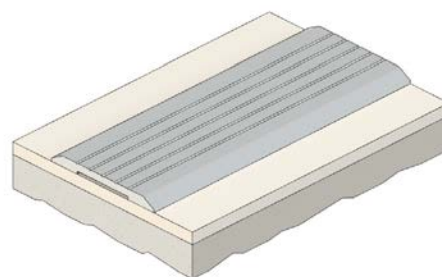
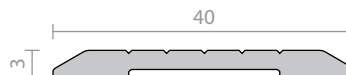

### RP96

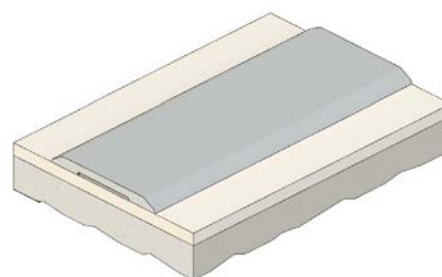

## RP112



A medium duty threshold plate which can be positioned back to back to form a two way threshold ramp conforming to NCC Pt. D2.15 Thresholds (b).

Can be used in conjunction with Raven door bottom seals to prevent rain, draughts, noise and smoke infiltration.

Can also be used to provide a ramped frame for internal door mats and tiles.

**Location:** Door sill.

**Finish:** Satin clear (silver) or bronze anodised aluminium (25µm).

**Fixing:** Screw fix. Colour matched zinc plated, cross recess head CSK S.T. screws supplied.

**Sizes:** Available in stock lengths.

### Approvals

Cert. G.VYI.R37913

**Access & Mobility AUS/NZ:** NCC D2.15 & D3.3. AS1428.1. NZ BC Compliance Doc. D1/AS1 1.3.2.  
**UK/EU:** Approved Document M.

**Fire AUS/NZ:** NCC Spec. C3.4. AS1530.4 & AS/NZS 1905.1. NZ BC Compliance Doc. C/AS1 6.19.2(a) & App. C6.1.1.

**UK/EU:** Approved Document B. BS 476 Pt. 20 & 22 (similar to BS EN 1634-1).

**FRL & FRR-/240/30 and FD240.**   
 when used with a BAL rated door bottom seal in accordance with AS 3959.

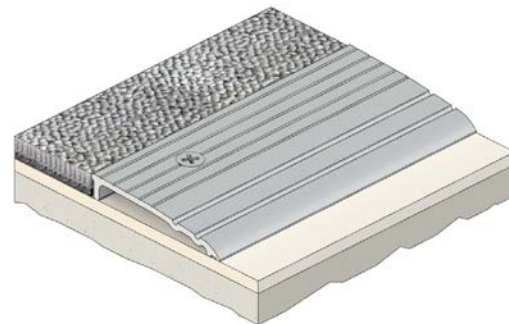
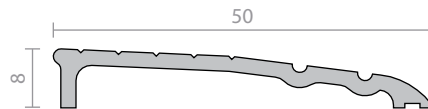

## RP115, RP116



Low profile threshold plates that can be used in conjunction with Raven door bottom seals to prevent rain, draughts, noise and smoke infiltration. Suitable for use with most floor pivots.

**Location:** Door sill.

**Finish:** Satin clear (silver) or bronze anodised aluminium (25µm).

**Fixing:** Screw fix or builders adhesive for concealed fixing (user determined). Colour matched zinc plated, cross recess head CSK S.T. screws supplied.

**Sizes:** Available in stock lengths.

### Approvals

**Access & Mobility AUS/NZ:** NCC D2.15 & D3.3. AS1428.1. NZ BC Compliance Doc. D1/AS1 1.3.2.  
**UK/EU:** Approved Document M.

**Fire AUS/NZ:** NCC Spec. C3.4. AS1530.4 & AS/NZS 1905.1. NZ BC Compliance Doc. C/AS1 6.19.2(a) & App. C6.1.1.

**UK/EU:** Approved Document B. BS 476 Pt. 20 & 22 (similar to BS EN 1634-1).

**FRL & FRR-/240/30 and FD180.**   
 when used with a BAL rated door bottom seal in accordance with AS 3959.

### RP115

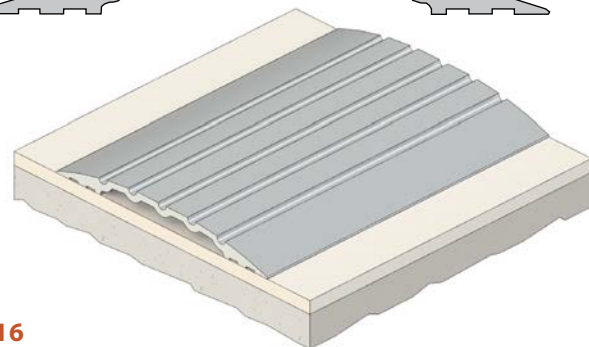
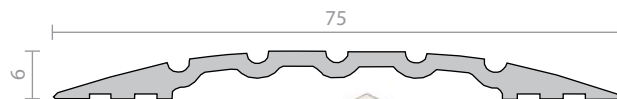

### RP116

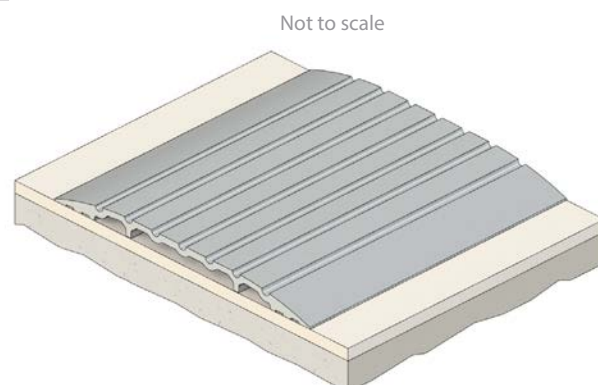
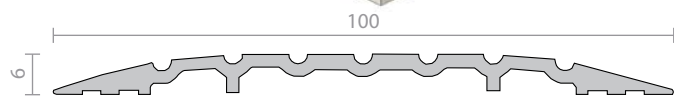

## RP137



A low profile, extra wide heavy duty threshold plate that can be used in conjunction with Raven door bottom seals to prevent rain, draughts, noise and smoke infiltration. Ideal for larger style commercial door frames.

**Location:** Door sill.

**Finish:** Satin clear (silver) anodised aluminium (25µm).

**Fixing:** Screw fix or builders adhesive for concealed fixing (user determined). Colour matched zinc plated, cross recess head CSK S.T. screws supplied.

**Sizes:** 3000mm, 2000mm, 1750mm, 1000mm.

### Approvals

Cert. GVYI.R37913

**Access & Mobility AUS/NZ:** NCC D2.15 & D3.3. AS1428.1. NZ BC Compliance Doc. D1/AS1 1.3.2.  
**UK/EU:** Approved Document M.

**Fire AUS/NZ:** NCC Spec. C3.4. AS1530.4 & AS/NZS 1905.1. NZ BC Compliance Doc. C/AS1 6.19.2(a) & App. C6.1.1.

**UK/EU:** Approved Document B. BS 476 Pt. 20 & 22 (similar to BS EN 1634-1).

**FRL & FRR-/240/30 and FD180.**

**BAL ≤FZ** when used with a BAL rated door bottom seal in accordance with AS 3959.

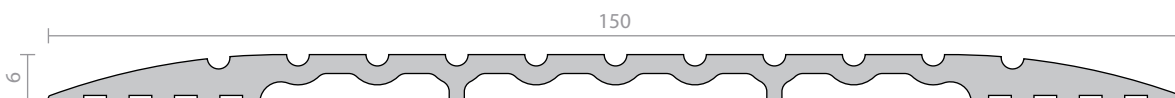
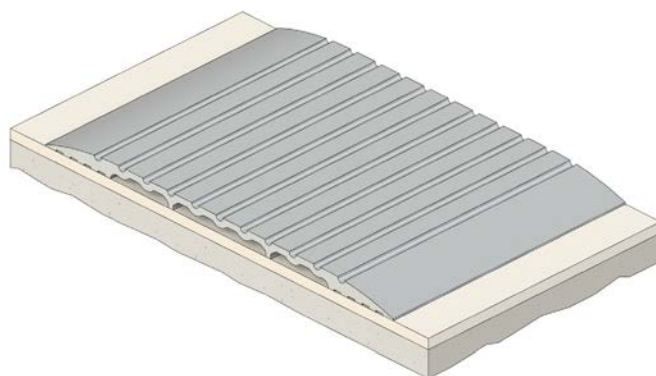

## RP138



A heavy duty threshold ramp that can be used as a border for internal floor matting or be positioned back to back to form a two way threshold ramp conforming to NCC Pt. D2.15 Thresholds (b).

Ideal for larger style commercial door frames.

RP138 has been designed to accommodate a concealed screw fix through the door jambs.

**Location:** Door sill.

**Finish:** Satin clear (silver) anodised aluminium (25µm).

**Fixing:** Screw fix or builders adhesive for concealed fixing (user determined). Colour matched zinc plated, cross recess head CSK S.T. screws supplied.

**Sizes:** 3000mm, 2500mm, 2000mm, 1250mm, 1000mm.

### Approvals

Cert. GVYI.R37913

**Access & Mobility AUS/NZ:** NCC D2.15 & D3.3. AS1428.1. NZ BC Compliance Doc. D1/AS1 1.3.2.  
**UK/EU:** Approved Document M.

**Fire AUS/NZ:** NCC Spec. C3.4. AS1530.4 & AS/NZS 1905.1. NZ BC Compliance Doc. C/AS1 6.19.2(a) & App. C6.1.1.

**UK/EU:** Approved Document B. BS 476 Pt. 20 & 22 (similar to BS EN 1634-1).

**FRL & FRR-/240/30 and FD180.**

**BAL ≤FZ** when used with a BAL rated door bottom seal in accordance with AS 3959.

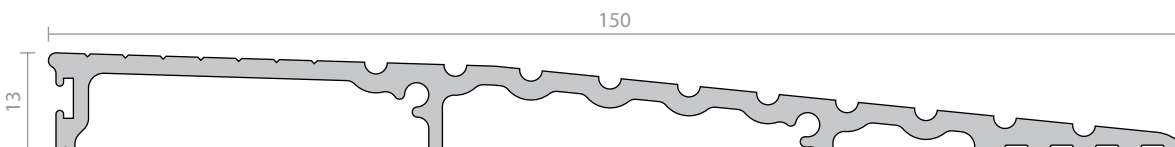



## Door Frame / Perimeter Seals

In this catalogue, seals designed for the gap between the door and the frame (up and down the jamb and across the head of the door) are termed door frame seals or perimeter seals.

These are generally compression seals. Some are mounted on the door stop or directly onto a plain frame of the door, thereby providing a door stop seal. Some seals can be fitted to the door or neatly rebated into the frame itself.

Many Raven perimeter seals have some degree of adjustability and can be adjusted after installation without removing the door or window. This ensures an optimum seal is achieved and maximum performance is maintained in the event of minor building movement.



## RP7



A rigid and flexible PVC door frame seal suitable for rebated timber frames. The RP7 rigid section can be painted. Used in conjunction with Raven door bottom seals and astragals.

**Location:** Timber head and jambs of single and double butt hinged doors.

**Min/Max Gap:** 0mm to 7mm (compression 1mm to 3mm).

**Fixing:** Nail fix. Zinc plated nails supplied.

**Seal:** White or brown rigid and flexible PVC. Can be painted.

**Sizes:** Available in single door sets.

### Approvals

**Energy** NCC Pt. 3.12.3.3 & J3.4.

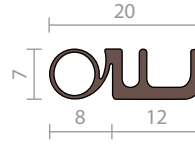

## RP10



An effective acoustic door stop frame seal which is quick and easy to install on plain or rebated door frames. Multi-fin design for improved noise and energy sealing. The minimum deflection design creates maximum sealing efficiency. RP10 can be mitred or butt jointed for a neat finish. Adjustable by large concealed fixing slots for a precision fit. RP10 has a tamper resistant, rigid PVC cover strip (SE). Can be used on all four sides of the door to form a bulk head seal.

*Note: If fixing to rebated frames of single doors, specify a long backset door latch.*

**Location:** Head and jambs of single and double butt hinged doors.

**Min/Max Gap:** 0mm to 10mm.

**Finish:** Satin clear (silver), bronze anodised aluminium (15µm) or paint at extra cost (page 7).

**Fixing:** Screw fix. Zinc plated, cross recess head S.T. screws supplied.

**Seal:** RP410. Black flexible PVC. Black rigid flexible PVC (SE) cover strip.

**Sizes:** Available in door set sizes or stock lengths.

### Approvals

**Acoustic AUS/NZ:** NCC Spec. F5.5.  
**UK/EU:** Approved Document E. Rated to BS EN ISO 717.1.

**Fire AUS/NZ:** NCC Spec. C3.4.  
AS1530.4 & AS/NZS 1905.1. NZ BC Compliance Doc. C/AS1 6.19.2 & App. C6.1.1.

**UK/EU:** Approved Document B.  
BS 476 Pt. 20 & 22 (similar to BS EN 1634-1).

**FRL & FRR-/240/30 and FD240.**

**Energy** NCC Pt. 3.12.3.3 & J3.4.

**Registered Design.**

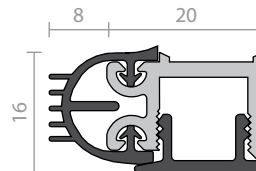

## RP10Si



An effective acoustic and smoke door stop frame seal which is quick and easy to install on plain or rebated door frames. Multi-fin design for improved noise and energy sealing. The minimum deflection design creates maximum sealing efficiency. RP10Si can be mitred or butt jointed for a neat finish. Adjustable by large concealed fixing slots for a precision fit, RP10Si has a tamper resistant, rigid PVC cover strip (SE). Can be used on all four sides of the door to form a bulk head seal.

*Note: If fixing to rebated frames of single doors, specify a long backset door latch.*

**Location:** Head and jambs of single and double butt hinged doors.

**Min/Max Gap:** 0mm to 10mm.

**Finish:** Satin clear (silver), bronze or black anodised aluminium (15µm) or paint at extra cost (page 7).

**Fixing:** Screw fix. Zinc plated, cross recess head S.T. screws supplied.

**Seal:** RP310Si. Black or light grey silicon rubber (SE).

**Sizes:** Available in door set sizes or stock lengths.

### Approvals

Cert. GVI1.R37913.

ANSI/BHMA A156.22.

**Acoustic AUS/NZ:** NCC Spec. F5.5.

**UK/EU:** Approved Document E. Rated to BS EN ISO 717.1.

**Fire AUS/NZ:** NCC Spec. C3.4.

AS1530.4 & AS/NZS 1905.1. NZ BC Compliance Doc. C/AS1 6.19.2 & App. C6.1.1.

**UK/EU:** Approved Document B. BS 476 Pt. 20 & 22 (similar to BS EN 1634-1).

**FRL & FRR-/240/60 and FD240.** Gasket flammability index 1 when tested to AS1530.2.

**Smoke** NCC Spec. C3.4. AS1530.7 & BS EN 1634-3. Meets smoke leakage rates specified in AS6905 & EN 13501-2 "Sa", "Sm".

**Energy** NCC Pt. 3.12.3.3 & J3.4.

**Registered Design.**

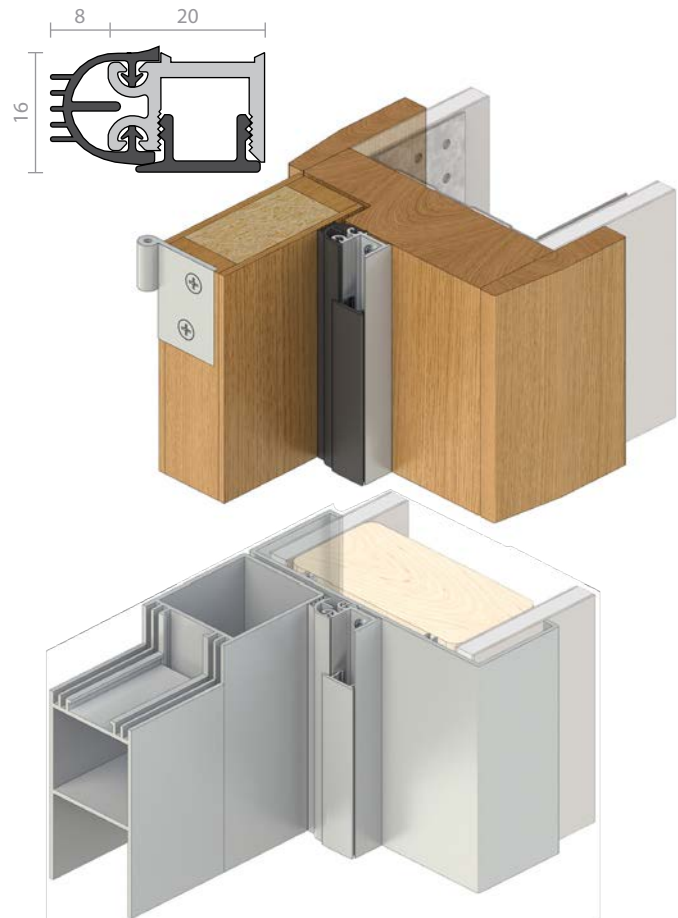

## RP12



The RP12 has a woven pile weather strip with unique Quiet-fins for noise protection. Ideal for sliding doors and designed to limit noise leakage and control dust and air movement. The RP12 is quick and easy to install to the door or frame.

Can be used in conjunction with a double row of RP2 seals fitted into grooves in the door bottom edge or face mount RP74 to achieve a complete sealing system.

**Location:** Head and jambs of door frames.

**Min/Max Gap:** 6mm to 8mm (prior to installation).

**Finish:** Satin clear (silver), bronze anodised aluminium (15µm) or paint at extra cost (page 7).

**Fixing:** Concealed screw fix. Zinc plated, cross recess head S.T. screws and cover strip supplied. Fixing holes are pre-slotted to allow the seals to be fitted accurately and adjustment to be made for building movement.

**Seal:** Black polypropylene pile with felt weather fins.

**Sizes:** Available in stock lengths.

### Approvals

**Energy** NCC Pt. 3.12.3.3 & J3.4.

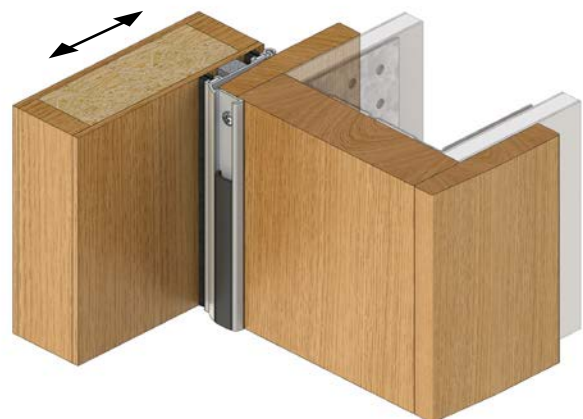
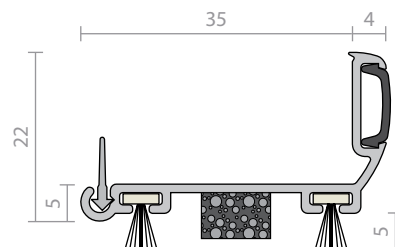

## RP23



A S.E. EPDM compression seal ideal for smoke and weather applications on butt hinged doors. Can be mitred or butt jointed for a neat finish. Its aluminium carrier is sturdy and slotted for adjustment with concealed fixings. It is quick and easy to install on door stops around the jamb and head and can be fitted without removing the door.

Can be used on all four sides of the door to form a bulk head seal.

*Note: A built up sill similar in profile to the stops will be required for bulkhead applications.*

**Location:** Head and jambs of single and double butt hinged doors or bulk head applications.

**Min/Max Gap:** 0mm to 7mm.

**Finish:** Satin clear (silver), bronze anodised aluminium (15µm) or paint at extra cost (page 7).

**Fixing:** Screw fix. Zinc plated, cross recess head S.T. screws and cover strip supplied.

**Seal:** RP323. Black EPDM (SE).

**Sizes:** Available in door set sizes or stock lengths.

### Approvals

**Acoustic AUS/NZ:** NCC Spec. F5.5.  
**UK/EU:** Approved Document E. Rated to BS EN ISO 717.1.

**Fire AUS/NZ:** NCC Spec. C3.4. AS1530.4 & AS/NZS 1905.1. NZ BC Compliance Doc. C/AS1 6.19.2 & App. C6.1.1.

**UK/EU:** Tests above are similar to BS EN 1634-1, BS 476 Pt. 20 & 22.  
**FRL & FRR-/240/60 and FD240.** 🔥

**Smoke** NCC Spec. C3.4. AS1530.7 & BS EN 1634-3. Meets smoke leakage rates specified in AS6905 & EN 13501-2 "Sa", "Sm".

**Energy** NCC Pt. 3.12.3.3 & J3.4.

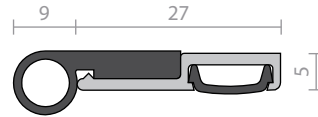

## RP24



Granted an Australian Design Award, the RP24 is an effective door stop seal for noise, light and smoke. It can be butt jointed for a neatly finished continuous seal, replacing the conventional doorstop on metal or timber framed doors. With tamper proof concealed fixings, the RP24 utilises independently adjustable screws to achieve up to 8mm sealing adjustment for maximum noise control. The closed cell S.E. EPDM seal only requires normal door closing force.

*Note: If fixing to rebated frames of single doors, specify a long backset door latch.*

**Location:** Head and jambs of single and double butt hinged doors.

**Min/Max Gap:** 0mm to 8mm.

**Finish:** Satin clear (silver) anodised aluminium (15µm) or paint at extra cost (page 7).

**Fixing:** Screw fix. Zinc plated, cross recess head S.T. screws and cover strip supplied.

**Seal:** RP338. Black closed cell sponge EPDM (SE).

**Sizes:** Available in door set sizes or stock lengths.

### Approvals

**Acoustic AUS/NZ:** NCC Spec. F5.5.  
**UK/EU:** Approved Document E. Rated to BS EN ISO 717.1.

**Fire AUS/NZ:** NCC Spec. C3.4. AS1530.4 & AS/NZS 1905.1. NZ BC Compliance Doc. C/AS1 6.19.2 & App. C6.1.1.

**UK/EU:** Tests above are similar to BS EN 1634-1, BS 476 Pt. 20 & 22.  
**FRL & FRR-/240/30 and FD240.** 🔥

**Energy** NCC Pt. 3.12.3.3 & J3.4.

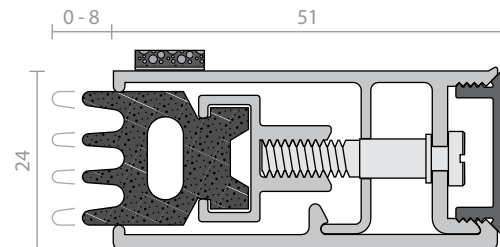

## RP24Si



RP24Si is an effective door stop seal for noise, light and smoke. It can be butt jointed for a neatly finished continuous seal, replacing the conventional doorstop on metal or timber framed doors. With tamper proof concealed fixings, the RP24Si utilises independently adjustable screws to achieve up to 8mm sealing adjustment for maximum noise control. The silicon rubber seal only requires normal door closing force.

*Note: If fixing to rebated frames of single doors, specify a long backset door latch.*

**Location:** Head and jambs of single and double butt hinged doors.

**Min/Max Gap:** 0mm to 8mm.

**Finish:** Satin clear (silver), bronze, black anodised aluminium (15µm) or paint at extra cost (page 7).

**Fixing:** Screw fix. Zinc plated, cross recess head S.T. screws and cover strip supplied.

**Seal:** RP338Si. Grey silicon rubber (SE).

**Sizes:** Available in door set sizes or stock lengths.

### Approvals

**UL** Cert. GVI1.R37913.

**Acoustic AUS/NZ:** NCC Spec. F5.5.  
**UK/EU:** Approved Document E. Rated to BS EN ISO 717.1.

**Fire AUS/NZ:** NCC Spec. C3.4. NZ BC Compliance Doc. C/AS1 6.19.2 & App. C6.1.1.

**UK/EU:** Approved Document B. BS EN 1634-1.

**FRL & FRR-/240/60 and FD240.**

To be used on door frames with a 25mm stop.  
Gasket flammability index 1 when tested to AS1530.2.

**Smoke** NCC Spec. C3.4. AS1530.7 & BS EN 1634-3. Meets smoke leakage rates specified in AS6905 & EN 13501-2 "Sa", "Sm".

**Energy** NCC Pt. 3.12.3.3 & J3.4.

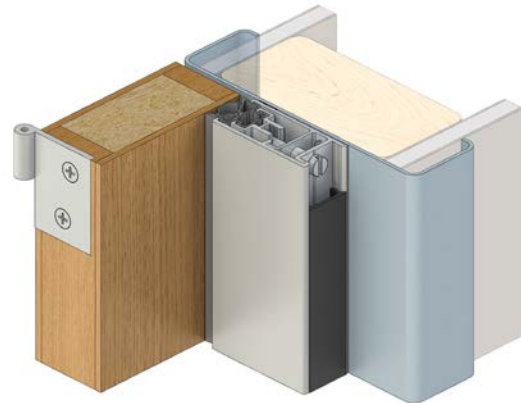
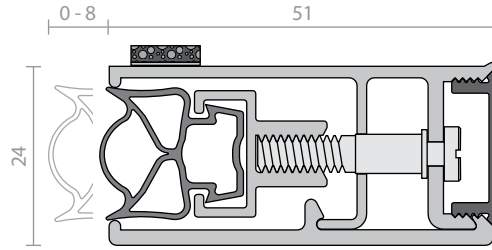

## RP39



A refrigeration type vinyl magnetic strip in an anodised aluminium housing. RP39 provides a tight seal for steel clad doors and jambs and may be used as a stop. For timber doors, a thin steel strip can be attached to the door face. The magnetic strip has sufficient closing strength that latches may not be required. It can also be used in pairs on meeting stiles of timber doors.

*Note: As an astragal seal, RP39 is best suited to infrequent use and door closer hold open applications.*

**Location:** Head, jambs and stiles of single and double butt hinged doors, sliding doors or bulkhead applications.

**Min/Max Gap:** 4mm to 8mm (meeting stiles).

**Finish:** Satin clear (silver) anodised aluminium (15µm) or paint at extra cost (page 7).

**Fixing:** Screw fix. Zinc plated, cross recess head S.T. screws supplied. Fixing holes are slotted.

**Seal:** Black PVC.

**Sizes:** Available in stock lengths.

### Approvals

**Fire AUS/NZ:** NCC Spec. C3.4. AS1530.4 & AS/NZS 1905.1. NZ BC Compliance Doc C/AS1 6.19.2(a) and App C6.1.1.

**UK/EU:** Approved Document B. BS 426 Pt. 20 & 22 (similar to BS EN 1634.1).

**FRL & FRR-/240/30 and FD240.**

**Energy** NCC Pt. 3.12.3.3 & J3.4.

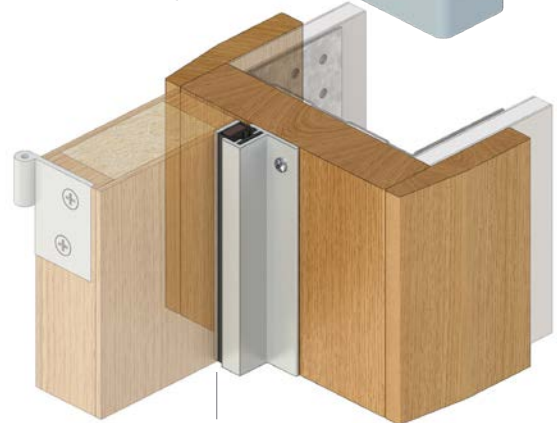
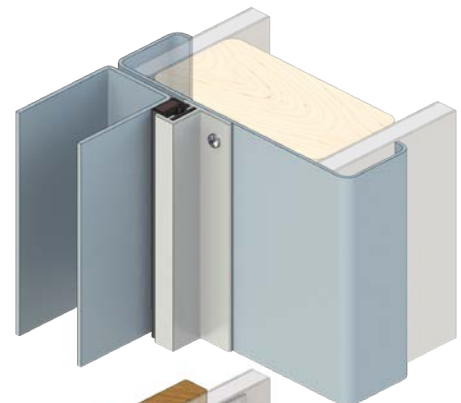
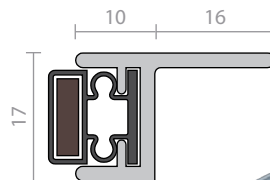

Timber door with steel insert (by others)

## RP44Si



An effective acoustic and medium temperature smoke seal, the RP44Si has two extruded silicon bulb gaskets and can be mitred or butt jointed for a neat finish. Can be installed on door stops with sufficient depth and broad butt hinges should be specified.

*Note: Check backset door latch requirements.*

**Location:** Head and jambs of single and double, broad butt hinged doors or bulkhead applications.

**Min/Max Gap:** 8mm to 10mm (allow 13mm to 14mm for installation, refer to product dimensions).

**Finish:** Satin clear (silver) anodised aluminium (15µm) or paint at extra cost (page 7).

**Fixing:** Screw fix. Zinc plated, cross recess head S.T. screws supplied.

**Seal:** RP308Si. Grey silicon rubber (SE).

**Sizes:** Available in stock lengths.

### Approvals

**Smoke AUS/NZ:** NCC Spec. C3.4. NZ BC Compliance Doc C/AS1 6.19.2(b).  
**UK/EU:** Approved Document B.  
 Gasket flammability index 1 when tested to AS1530.2.

**Energy** NCC Pt. 3.12.3.3 & J3.4.

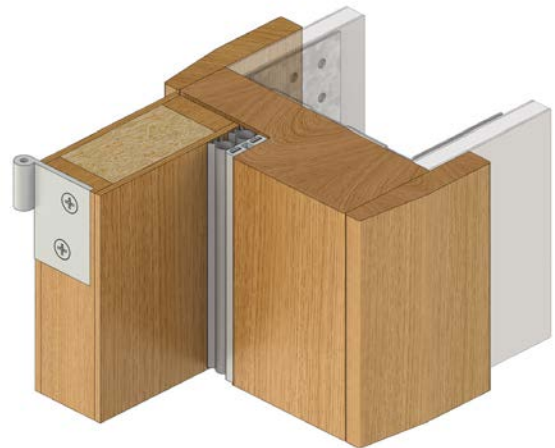
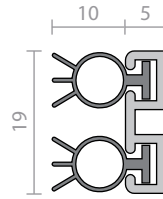

## RP47Si



A heavy duty seal designed to replace the conventional door stop. The RP47Si is ideal for medium temperature smoke / fire door applications and has excellent acoustic qualities for heavy traffic areas. With concealed fixings and adjustable fastener slots to achieve an optimum seal, a space for low voltage cable management can be found behind a tamper proof cover strip. RP47Si can be mitred or butt jointed for a neat installation. Can be used on all four sides of the door to form a bulk head seal.

*Note: If fixing to rebated frames of single doors, specify a long backset door latch.*

**Location:** Head and jambs of single and double butt hinged doors or bulk head applications.

**Min/Max Gap:** 0mm to 17mm.

**Finish:** Satin clear (silver), black anodised aluminium (15µm) or paint at extra cost (page 7).

**Fixing:** Concealed screw fix. Zinc plated, Tek self drilling screws (metal) supplied.

**Seal:** RP347Si. Black silicon rubber (SE).

**Sizes:** Available in door set sizes or stock lengths.

### Approvals

Cert. GVI.R37913.

**Acoustic AUS/NZ:** NCC Spec. F5.5.  
**UK/EU:** Approved Document E. Rated to BS EN ISO 717.1.

**Fire AUS/NZ:** NCC Spec. C3.4. NZ BC Compliance Doc C/AS1 6.19.2 & App C6.1.1.

**UK/EU:** Approved Document B. BE EN 1634-1.

**FRL & FRR-/240/30.** To be used on door frames with a 25mm stop. Gasket flammability index 1 when tested to AS1530.2.

**Smoke** NCC Spec. C3.4. AS1530.7 & BS EN 1634-3. Meets smoke leakage rates specified in AS6905 & EN 13501-2 "Sa", "Sm".

**Energy** NCC Pt. 3.12.3.3 & J3.4.

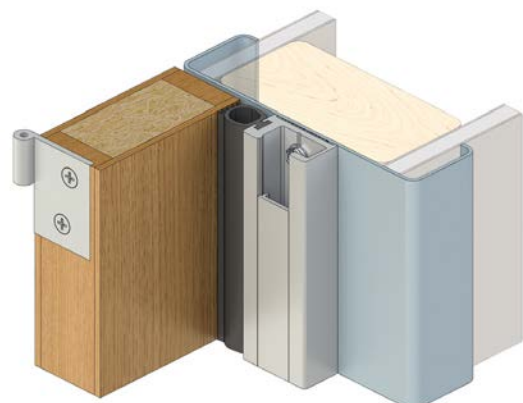
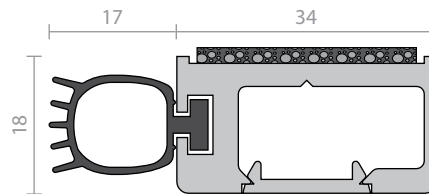

## RP56



A PVC finned sweep seal designed to fit into a groove around the perimeter of a timber door or frame to reduce noise and air movement. This unobtrusive seal is discrete in appearance and does not restrict the doors operation.

The RP56 can be used in conjunction with Raven automatic door bottom seals and brush strip seals.

*Note: Check latching requirements.*

**Location:** Perimeter of internal timber doors or frame.

**Min/Max Gap:** 2mm to 4mm.

**Fixing:** Adhesive fix into a 10mm x 4mm groove.

**Seal:** RP469. Black flexible PVC. Bronze rigid PVC holder.

**Sizes:** Available in stock lengths.

### Approvals

**Fire AUS/NZ:** NCC Spec. C3.4. AS1530.4 & AS/NZS 1905.1. NZ BC Compliance Doc. C/AS1 6.19.2(a) & App. C6.1.1.

**UK/EU:** Approved Document B. Tests above are similar to BS EN 1634-1 & BS 476 Pt. 20 & 22.

**FRL & FRR-/60/30 and FD60.** on door bottom only.

**Energy** NCC Pt. 3.12.3.3 & J3.4.

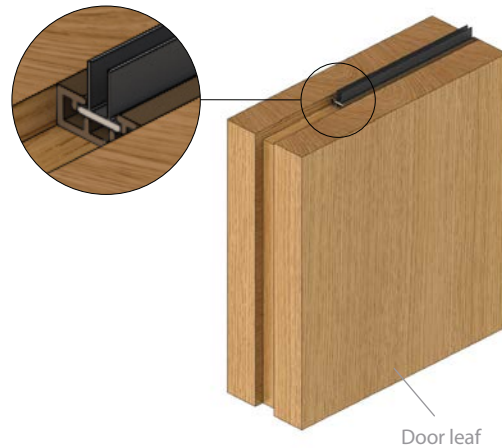
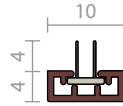

Door leaf

## RP69



A woven pile sweep seal designed to fit into a groove around the perimeter of a timber door or frame to reduce air movement. This unobtrusive seal is discrete in appearance and does not restrict the doors operation.

The RP69 can be used in conjunction with Raven automatic door bottom seals and brush strip seals.

*Note: Check latching requirements.*

**Location:** Perimeter of internal timber doors or frame.

**Min/Max Gap:** 3mm to 4mm.

**Fixing:** Adhesive fix into a 10mm x 4mm groove.

**Seal:** Bronze rigid PVC holder with black woven polypropylene pile weather strip.

**Sizes:** Available in stock lengths.

### Approvals

**Energy** NCC Pt. 3.12.3.3 & J3.4.

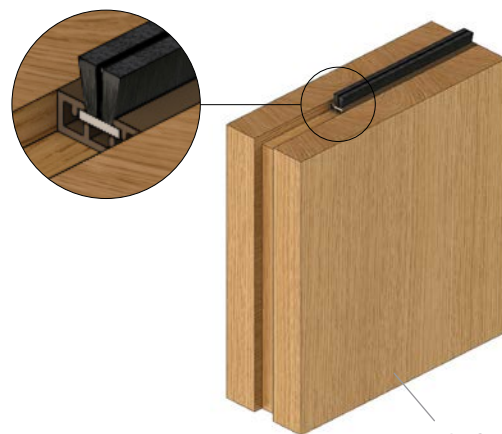
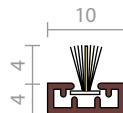

Door leaf

## RP73



An extremely flexible co-extruded PVC sweep seal that fits into a saw kerf groove cut into the frame or door. It holds tight radii and compound curves when bent around a frame. It resists UV, ozone, mildew and colour change.

The RP73 can be used in conjunction with Raven automatic door bottom seals and brush strip seals.

**Location:** Perimeter of timber sliding doors, pivot doors and door frames.

**Min/Max Gap:** 6mm to 8mm.

**Fixing:** Push-in locking fit into a 2.5mm x 6mm deep kerf groove.

**Seal:** Brown rigid and flexible PVC.

**Sizes:** Coils of 1m increments up to 100m.

### Approvals

**Energy** NCC Pt. 3.12.3.3 & J3.4.

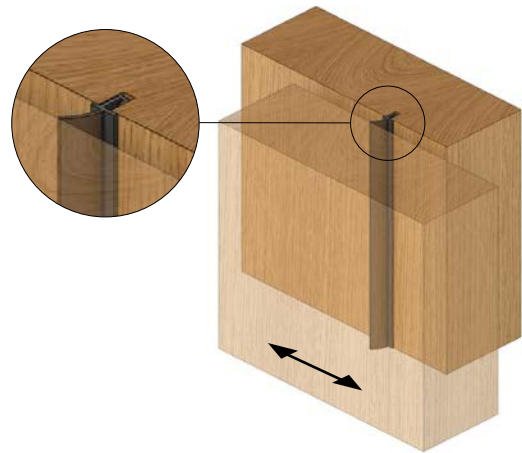
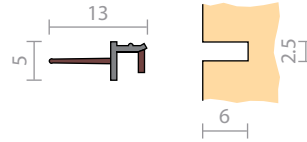

## RP78Si



An acoustic medium temperature smoke door frame seal designed for installation on door stops. Its aluminium carrier is sturdy and slotted for adjustment with concealed fixings. It is quick and easy to install around the jamb and head and can be fitted without removing the door. The RP78Si can be mitred or butt jointed for a neat finish.

Can be used in conjunction with the Raven RP8Si, RP16Si, RP35Si, RP38Si, RP99Si, RP126Si, RP127Si or RP128Si automatic door bottom seals.

**Location:** Head and jambs of single and double butt hinged doors.

**Min/Max Gap:** 0mm to 6mm.

**Finish:** Satin clear (silver), bronze anodised aluminium (15µm) or paint at extra cost (page 7).

**Fixing:** Concealed screw fix. Zinc plated, cross recess head S.T. screws, self drilling screws (metal) and cover strip supplied.

**Seal:** RP394Si. Grey or light grey silicon rubber (SE).

**Sizes:** Available in door set sizes or stock lengths.

### Approvals

**UL** Cert. GVI.R37913.

ANSI/BHMA A156.22.

**Acoustic AUS/NZ:** NCC Spec. F5.5.  
**UK/EU:** Approved Document E. Rated to BS EN ISO 717.1.

**Fire AUS/NZ:** NCC Spec. C3.4.  
AS1530.4 & AS/NZS 1905.1. NZ BC Compliance Doc. C/AS1 6.19.2 & App. C6.1.1.

**UK/EU:** Approved Document B.  
BS 476 Pt. 20 & 22 (similar to BS EN 1634-1).

**FRL & FRR-240/60 and FD240.**   
Gasket flammability index 1 when tested to AS1530.2.

**Smoke** NCC Spec. C3.4. AS1530.7 & BS EN 1634-3. Meets smoke leakage rates specified in AS6905 & EN 13501-2 "Sa", "Sm".

**Energy** NCC Pt. 3.12.3.3 & J3.4.



## RP78HSi



This medium temperature smoke seal is designed for clean room and health care facilities. RP78HSi has an easy wipe clean design where the smooth sealing gasket also contains an antimicrobial additive for maximum protection against surface bacteria.

For installation on door stops. Its aluminium carrier is sturdy and slotted for adjustment with concealed fixings. It is quick and easy to install around the jamb and head and can be fitted without removing the door. The RP78Si can be mitred or butt jointed for a neat finish.

Can be used in conjunction with the Raven RP8Si, RP16Si, RP35Si, RP38Si, RP99Si, RP126Si, RP127Si or RP128Si automatic door bottom seals.

**Location:** Head and jambs of single and double butt hinged doors.

**Min/Max Gap:** 0mm to 6mm.

**Finish:** Satin clear (silver) anodised aluminium (15µm) or paint at extra cost (page 7).

**Fixing:** Concealed screw fix. Zinc plated, cross recess head S.T. screws, self drilling screws (metal) and cover strip supplied.

**Seal:** RP394HSi. Grey or light grey silicon rubber (SE).

**Sizes:** Available in door set sizes.

### Approvals

**Fire AUS/NZ:** NCC Spec. C3.4. AS1530.4 & AS/NZS 1905.1. NZ BC Compliance Doc. C/AS1 6.19.2 & App. C6.1.1.

**UK/EU:** Approved Document B. BS 476 Pt. 20 & 22 (similar to BS EN 1634-1).

**FRL & FRR-/240/30 and FD240.** Gasket flammability index 1 when tested to AS1530.2.

**Smoke** NCC Spec. C3.4. AS1530.7 & BS EN 1634-3. Meets smoke leakage rates specified in AS6905 & EN 13501-2 "Sa", "Sm".

**Energy** NCC Pt. 3.12.3.3 & J3.4.

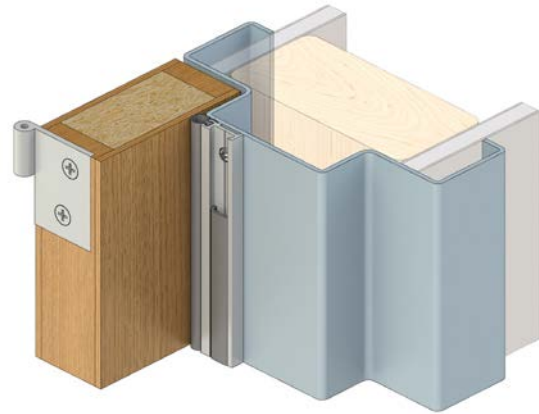
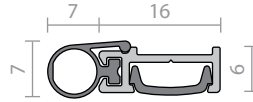

## RP84Si



This medium temperature smoke seal is designed specifically for clean room and health care facilities. RP84Si has an easy clean smooth bulb which also contains an antimicrobial additive for maximum protection against surface bacteria. RP84Si significantly reduces sound transmission and helps prevent the movement of airborne contaminants allowing for controlled air ventilation.

The RP84Si is ideal for use in conjunction with Raven door bottom seals and astragals.

**Location:** Head and jambs of single and double butt hinged doors.

**Min/Max Gap:** 0mm to 7mm.

**Finish:** Satin clear (silver) anodised aluminium (15µm) or paint at extra cost (page 7).

**Fixing:** Concealed screw fix. Zinc plated, cross recess head S.T. screws and cover strip supplied.

**Seal:** RP384Si. Black silicon rubber (SE).

**Sizes:** Available in door set sizes or stock lengths.

### Approvals

**UL** Cert. GVV1.R37913.

**Acoustic AUS/NZ:** NCC Spec. F5.5. **UK/EU:** Approved Document E. Rated to BS EN ISO 717.1.

### Fire

**FRL & FRR-/240/30 and FD240.** Gasket flammability index 1 when tested to AS1530.2.

**Smoke** NCC Spec. C3.4. AS1530.7 & BS EN 1634-3. Meets smoke leakage rates specified in AS6905 & EN 13501-2 "Sa", "Sm".

**Energy** NCC Pt. 3.12.3.3 & J3.4.

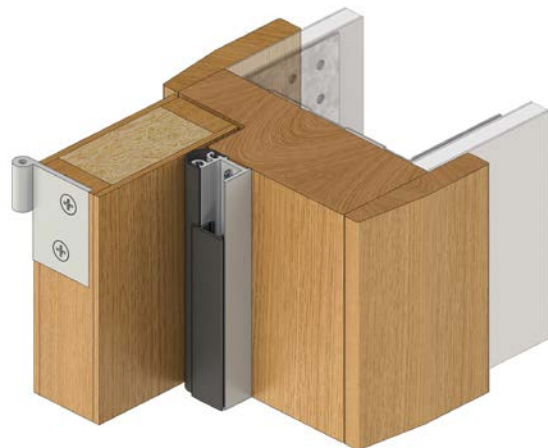
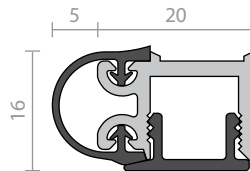



## RP85



A refrigeration type vinyl magnetic strip in an anodised aluminium housing with concealed fixings. RP85 provides a tight seal for steel clad doors and jambs and may be used as a stop. For timber doors, a thin steel strip can be attached to the door face. The magnetic strip has sufficient closing strength that latches may not be required.

Can be used in conjunction with Raven door bottom seals and astragals.

*Note: If fixing to rebated frames of single doors, specify a long backset door latch.*

**Location:** Head and jambs of single and double butt hinged doors.

**Min/Max Gap:** 0mm to 4mm (user determined).

**Finish:** Satin clear (silver) anodised aluminium (15µm) or paint at extra cost (page 7).

**Fixing:** Concealed screw fix. Zinc plated, cross recess head S.T. screws and cover strip supplied.

**Seal:** Black PVC.

**Sizes:** Available in stock lengths.

### Approvals

**Acoustic AUS/NZ:** NCC Spec. F5.5.  
**UK/EU:** Approved Document E. Rated to BS EN ISO 717.1.

**Energy** NCC Pt. 3.12.3.3 & J3.4.

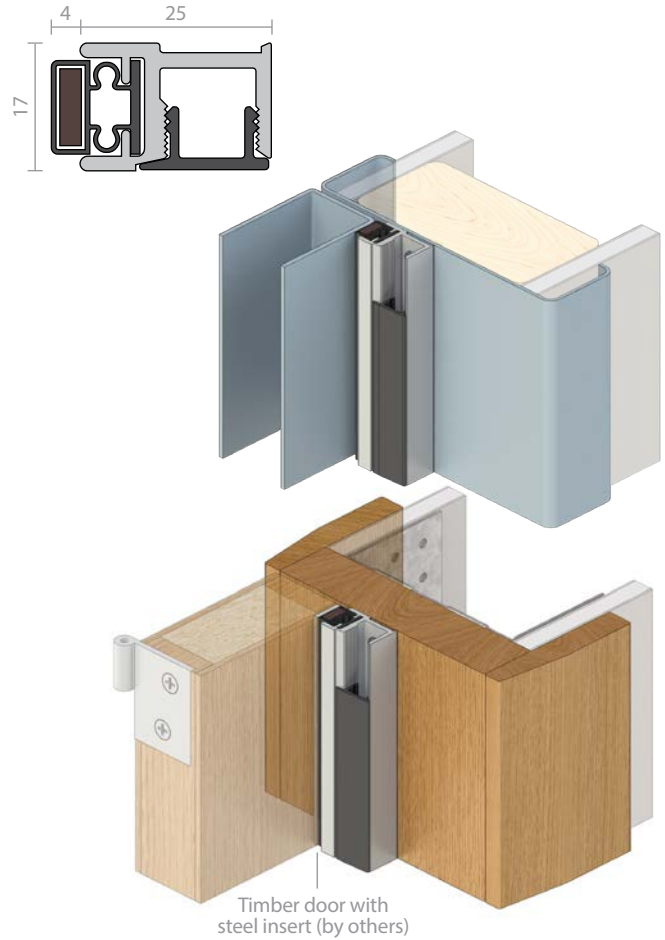

## RP87Si



RP87Si is an effective door stop seal for noise, light and smoke. It can be butt jointed for a neatly finished continuous seal, replacing the conventional doorstop on metal or timber framed doors. With tamper proof concealed fixings, the RP87Si utilises independently adjustable screws to achieve up to 6mm sealing adjustment for maximum noise control. The silicon rubber seal only requires normal door closing force.

*Note: If fixing to rebated frames of single doors, specify a long backset door latch.*

**Location:** Head and jambs of single and double butt hinged doors.

**Min/Max Gap:** 0mm to 6mm.

**Finish:** Satin clear (silver) anodised aluminium (15µm) or paint at extra cost (page 7).

**Fixing:** Concealed screw fix. Zinc plated, cross recess head S.T. screws and cover strip supplied.

**Seal:** RP310Si. Black silicon rubber (SE).

**Sizes:** Available in door set sizes or stock lengths.

### Approvals

Cert. GVI.R37913.

**Acoustic AUS/NZ:** NCC Spec. F5.5.  
**UK/EU:** Approved Document E. Rated to BS EN ISO 717.1.

**Fire AUS/NZ:** NCC Spec. C3.4.  
AS1530.4 & AS/NZS 1905.1. NZ BC Compliance Doc. C/AS1 6.19.2 & App. C6.1.1.

**UK/EU:** Approved Document B.  
BS EN 1634-1.

**FRL & FRR-/240/30 and FD240.**   
Gasket flammability index 1 when tested to AS1530.2.

**Smoke** NCC Spec. C3.4. AS1530.7 & BS EN 1634-3. Meets smoke leakage rates specified in AS6905 & EN 13501-2 "Sa", "Sm".

**Energy** NCC Pt. 3.12.3.3 & J3.4.

**Registered Design.**

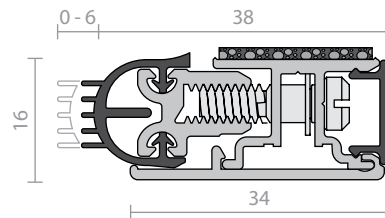

## RP87HSi



Designed for clean room and health care facilities, the RP87HSi has an easy wipe clean design where the smooth silicon sealing gasket also contains an antimicrobial additive for maximum protection against surface bacteria.

RP87HSi is an effective door stop seal for noise, light and medium temperature smoke. It can be butt jointed for a neatly finished continuous seal, replacing the conventional doorstop on metal or timber framed doors. With tamper proof concealed fixings, the RP87HSi utilises independently adjustable screws to achieve up to 6mm sealing adjustment for maximum noise control. The silicon seal only requires normal door closing force.

*Note: If fixing to rebated frames of single doors, specify a long backset door latch.*

**Location:** Head and jambs of single and double butt hinged doors.

**Min/Max Gap:** 0mm to 6mm.

**Finish:** Satin clear (silver) anodised aluminium (15µm) or paint at extra cost (page 7).

**Fixing:** Concealed screw fix. Zinc plated, cross recess head S.T. screws and cover strip supplied.

**Seal:** RP384Si. Black silicon rubber (SE).

**Sizes:** Available in door set sizes.

### Approvals

**Acoustic AUS/NZ:** NCC Spec. F5.5.  
**UK/EU:** Approved Document E. Rated to BS EN ISO 717.1.

**Fire AUS/NZ:** NCC Spec. C3.4.  
AS1530.4 & AS/NZS 1905.1. NZ BC Compliance Doc. C/AS1 6.19.2 & App. C6.1.1.

**UK/EU:** Approved Document B.  
**FRL & FRR-/240/30 and FD240.** 🔥  
Gasket flammability index 1 when tested to AS1530.2.

**Smoke** NCC Spec. C3.4. AS1530.7 & BS EN 1634-3. Meets smoke leakage rates specified in AS6905 & EN 13501-2 "Sa", "Sm".

**Energy** NCC Pt. 3.12.3.3 & J3.4.

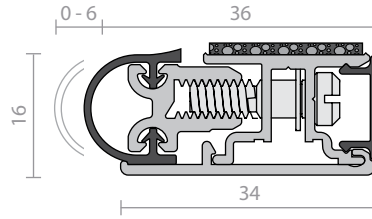

## RP93Si



A weather and acoustic seal suitable for plain or rebated frames. RP93Si is quick and easy to install (mitre joint only) to the head and jambs without removing the door. Slotted for installation adjustment, the soft silicon bulb accommodates a tighter seal and, with a tamper proof cover strip, provides a fit and forget feature.

*Note: If fixing to rebated frames of single doors, specify a long backset door latch. The tamper proof aluminium cover strip is not recommended for removal once installed. Refer to RP10Si or RP78Si for this feature.*

**Location:** Head and jambs of single and double butt hinged doors.

**Min/Max Gap:** 0mm to 6mm.

**Finish:** Satin clear (silver) anodised aluminium (15µm) or paint at extra cost (cover strip only).

**Fixing:** Screw fix. Zinc plated, cross recess head S.T. screws and cover strip supplied.

**Seal:** RP393Si. Black silicon rubber (SE).

**Sizes:** Available in door set sizes or stock lengths.

### Approvals

UL Cert. GVI1.R37913.

**Acoustic AUS/NZ:** NCC Spec. F5.5.  
**UK/EU:** Approved Document E. Rated to BS EN ISO 717.1.

**Fire AUS/NZ:** NCC Spec. C3.4.  
AS1530.4 & AS/NZS 1905.1. NZ BC Compliance Doc. C/AS1 6.19.2 & App. C6.1.1.

**UK/EU:** Approved Document B.  
BS 476 Pt. 20 & 22 (similar to BS EN 1634-1).

**FRL & FRR-/240/30 and FD240.** 🔥  
Gasket flammability index 1 when tested to AS1530.2.

**Smoke** NCC Spec. C3.4. AS1530.7 & BS EN 1634-3. Meets smoke leakage rates specified in AS6905 & EN 13501-2 "Sa", "Sm".

**Energy** NCC Pt. 3.12.3.3 & J3.4.

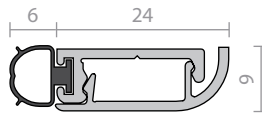

## RP94Si



A weather and acoustic seal, suitable for rebated frames. RP94Si is quick and easy to install, either mitred or butt jointed to the head and jambs without removing the door. Slotted for installation adjustment, the soft silicon bulb accommodates a tighter seal and with a tamper proof cover strip, provides a fit and forget feature.

Can be used in conjunction with Raven door bottom seals, astragals and threshold plates.

*Note: The tamper proof aluminium cover strip is not recommended for removal once installed. Refer to RP78Si or RP10Si for this feature.*

**Location:** Head and jambs of single and double butt hinged doors.

**Min/Max Gap:** 0mm to 6mm.

**Finish:** Satin clear (silver), black anodised aluminium (15µm) or paint at extra cost (cover strip only).

**Fixing:** Screw fix. Zinc plated, cross recess head S.T. screws and cover strip supplied.

**Seal:** RP394Si. Grey silicon rubber (SE).

**Sizes:** Available in door set sizes or stock lengths.

### Approvals

**UL** Cert. GVI.R37913.

**Acoustic AUS/NZ:** NCC Spec. F5.5.  
**UK/EU:** Approved Document E. Rated to BS EN ISO 717.1.

**Fire AUS/NZ:** NCC Spec. C3.4.  
AS1530.4 & AS/NZS 1905.1. NZ BC Compliance Doc. C/AS1 6.19.2 & App. C6.1.1.

**UK/EU:** Approved Document B.  
BS 476 Pt. 20 & 22 (similar to BS EN 1634-1).

**FRL & FRR-/240/30 and FD240.**   
Gasket flammability index 1 when tested to AS1530.2.

**Smoke** NCC Spec. C3.4. AS1530.7 & BS EN 1634-3. Meets smoke leakage rates specified in AS6905 & EN 13501-2 "Sa", "Sm".

**Energy** NCC Pt. 3.12.3.3 & J3.4.

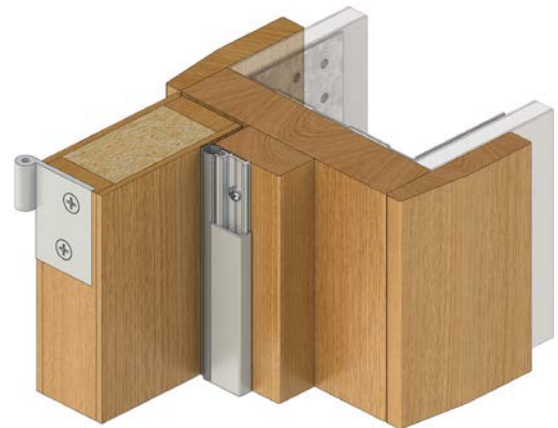
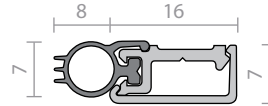

## RP113



A timber door stop frame seal suitable for plain or rebated frames.

Can be used in conjunction with Raven door bottom seals and astragals.

*Note: If fixing to rebated frames of single doors, specify a long backset door latch.*

**Location:** Head and jambs of single and double butt hinged doors.

**Min/Max Gap:** 0mm to 7mm.  
(Compression 1mm to 3mm).

**Finish:** Genuine plantation Tasmanian oak.

**Fixing:** Nail fix. Zinc plated nails supplied.

**Seal:** RP320. Brown silicon rubber.

**Sizes:** Available in single and double door set sizes.

### Approvals

**Acoustic AUS/NZ:** NCC Spec. F5.5.  
**UK/EU:** Approved Document E. Rated to BS EN ISO 717.1.

**Smoke AUS/NZ:** NCC Spec. C3.4 for smoke doors. NZ BC Compliance Doc. C/AS1 6.19.2(b).

**UK/EU:** Approved Document B.

**Energy** NCC Pt. 3.12.3.3 & J3.4.

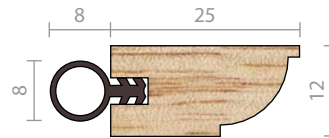

## RP118Si



A smoke, weather and acoustic door frame seal suitable for outward opening butt hinged doors.

Designed to accommodate a latch engagement for suitable panic exit devices at the head of the door. The RP118Si used in conjunction with the RP117Si threshold plate seal provides a bulkhead seal around the door with a top and bottom latch engagement.

Quick and easy to install with a mitre joint without removing the door, the RP118Si is slotted for adjustment and has concealed fixings.

**Location:** Head and jambs of single and double butt hinged doors.

**Min/Max Gap:** 0mm to 10mm.

**Finish:** Satin clear (silver) anodised aluminium (15µm) or paint at extra cost (page 7).

**Fixing:** Screw fix. Zinc plated, cross recess head S.T. screws and cover strip supplied.

**Seal:** RP308Si. Grey silicon rubber (SE).

**Sizes:** Available in stock lengths.

### Approvals

Cert. GVV1.R37913.

**Acoustic AUS/NZ:** NCC Spec. F5.5.  
**UK/EU:** Approved Document E. Rated to BS EN ISO 717.1.

**Smoke AUS/NZ:** NCC Spec. C3.4. NZ BC Compliance Doc. C/AS1 6.19.2 & App. C6.1.1.  
**UK/EU:** Approved Document B.

Gasket flammability index 1 when tested to AS1530.2.

**Energy** NCC Pt. 3.12.3.3 & J3.4.

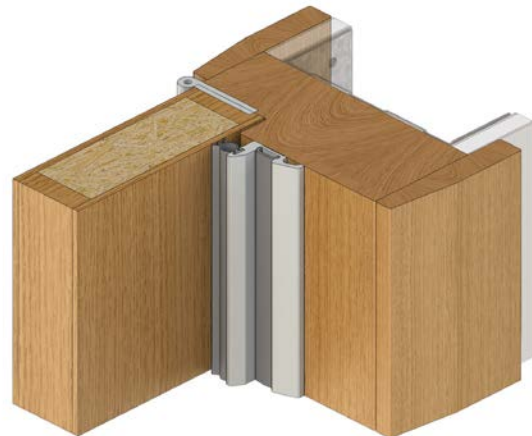
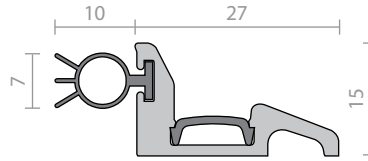

## RP120, RP150



Delta Seal™

RP120 and RP150 are co-extruded PVC acoustic and smoke seals. Discreetly located in the protected corners of rebated timber or steel door and window frames. RP120 is suitable for new and retrofit applications.

Can be used in conjunction with Raven door bottom seals and astragals and threshold plates.

**Location:** Around rebated frames of single and double butt hinged doors and windows.

**Min/Max Gap:** 3mm to 5.5mm.

**Fixing:** Aggressive self adhesive backing tape on both sides of the carrier.

*Note: Contact surface must be clean, smooth and if painted, well cured. Self adhesive seals will not adhere to oiled or alkyl finishes or to easy clean wash and wear paint surfaces.*

**Seal:** Black or white co-extruded rigid and flexible flame retardant PVC.

**Sizes:** Available in door set sizes.

### Approvals

Cert. GVV1.R37913.

**Acoustic AUS/NZ:** NCC Spec. F5.5.  
**UK/EU:** Approved Document E. Rated to BS EN ISO 717.1.

**Fire AUS/NZ:** NCC Spec. C3.4. AS1530.4 & AS/NZS 1905.1. NZ BC Compliance Doc. C/AS1 6.19.2 & App. C6.1.1.  
**UK/EU:** Approved Document B. (Tests above are similar to BS EN 1634-1 & BS 476 Pt. 20 & 22).  
**FRL & FRR-/240/30 and FD240.**

**Smoke** NCC Spec. C3.4. AS1530.7 & BS EN 1634-3. Meets smoke leakage rates specified in AS6905 & EN 13501-2 "Sa", "Sm".

**Energy** NCC Pt. 3.12.3.3 & J3.4.

### RP120

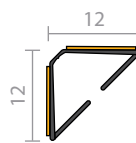

### RP150

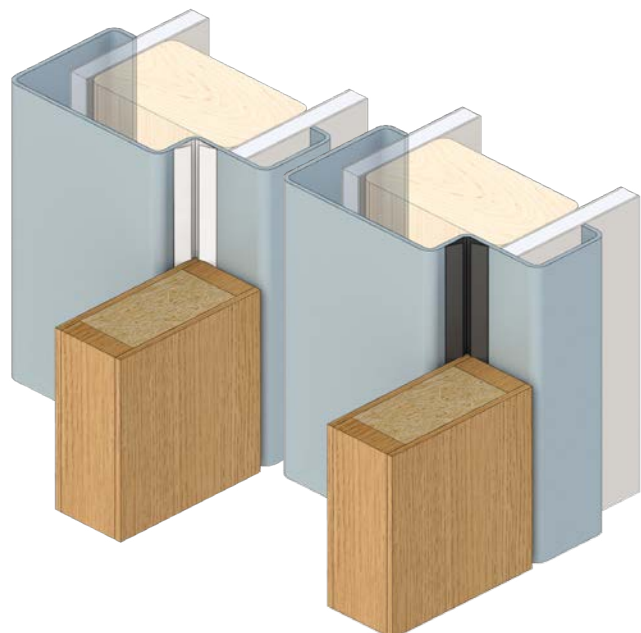
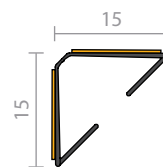

## RP124



The RP124 is the Delta Seal Plus™, a rigid and flexible co-polymer acoustic smoke seal with multiple fins and quick and easy self adhesive installation. The RP124 is located in the protected corners of rebated timber or steel frame doors and is suitable for new and retrofit applications.

Can be used in conjunction with Raven door bottom seals and astragals and threshold plates.

**Location:** Around rebated frames of single and double butt hinged doors.

**Min/Max Gap:** 3mm to 5.5mm.

**Fixing:** Aggressive self adhesive backing tape on both sides of the carrier.

*Note: Contact surface must be clean, smooth and if painted, well cured. Self adhesive seals will not adhere to oiled or alkyd finishes or to easy clean wash and wear paint surfaces.*

**Seal:** Black co-extruded rigid and flexible flame retardant PVC.

**Sizes:** Available in door set sizes.

### Approvals

**UL** Cert. GVI.R37913.

**Acoustic AUS/NZ:** NCC Spec. F5.5.  
**UK/EU:** Approved Document E. Rated to BS EN ISO 717.1.

**Fire AUS/NZ:** NCC Spec. C3.4.  
AS1530.4 & AS/NZS 1905.1. NZ BC Compliance Doc. C/AS1 6.19.2 & App. C6.1.1.

**UK/EU:** Approved Document B.  
BS 476 Pt. 20 & 22 (similar to BS EN 1634-1).

**FRL & FRR-120/30 and FD120.** 🔥

**Smoke** NCC Spec. C3.4. AS1530.7 & BS EN 1634-3. Meets smoke leakage rates specified in AS6905 & EN 13501-2 "Sa", "Sm".

**Energy** NCC Pt. 3.12.3.3 & J3.4.

**Registered Design.**

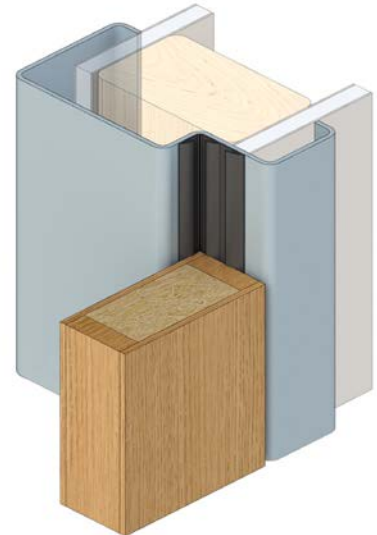
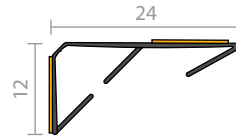

## RP130Si



A heavy duty medium temperature smoke seal designed to be fitted to the door head & jamb reveal of pivot door frames. May also be installed to the door stile edges and to one leaf of plain meeting stiles of timber double pivot doors. The aluminium body of the seal can be checked out or drilled to accommodate pivot hardware and latch ware at the meeting stile.

**Location:** Around frames of single and double acting pivot doors and the stiles of timber doors.

**Min/Max Gap:** 14mm to 18mm.

**Finish:** Satin clear (silver) anodised aluminium (15µm) or paint at extra cost (page 7).

**Fixing:** Screw fix. Zinc plated, cross recess head S.T. screws and cover strip supplied.

**Seal:** RP3129Si. Fins: Light grey silicon rubber (SE). Cover strip: Light grey PVC.

**Sizes:** Available in door set sizes or stock lengths.

### Approvals

**Fire** Gasket flammability index 1 when tested to AS1530.2.

**Smoke** NCC Spec. C3.4. AS1530.7 & BS EN 1634-3. Meets smoke leakage rates specified in AS6905 & EN 13501-2 "Sa", "Sm".

**Energy** NCC Pt. 3.12.3.3 & J3.4.

**Registered Design.**

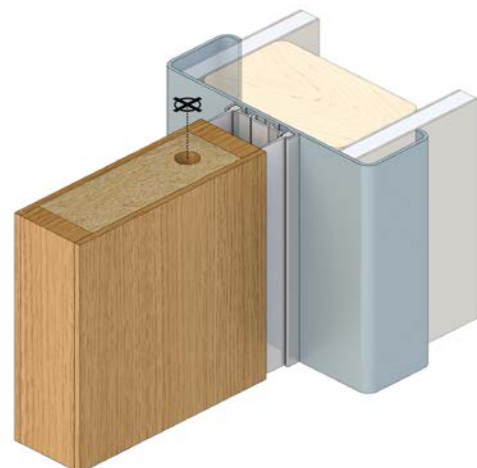
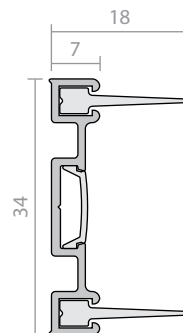

## RP134



The RP134 Delta Kerf Seal™ is a co-extruded PVC acoustic and smoke seal. Discreetly located in the protected corners of rebated timber doors and window frames. RP134 is suitable for new and retrofit applications.

**Location:** Around rebated frames of single and double butt hinged doors and windows.

**Min/Max Gap:** 3mm to 5.5mm.

**Fixing:** 3mm x 6mm deep kerf groove, push-in locking fit.

**Seal:** Black co-extruded rigid and flexible flame retardant PVC.

**Sizes:** Available in door set sizes or stock lengths.

### Approvals

**Energy** NCC Pt. 3.12.3.3 & J3.4.

**Registered Design.**

Optional fitting detail

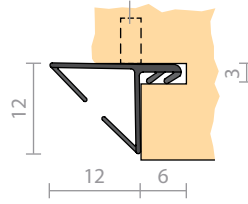

## RP670



A flame retardant TPE rubber compression seal ideal for smoke doors. The RP670 has a high resistance to permanent set (memory), is UV resistant and has an increased life cycle compared to traditional plastic covered foam strips.

*Note: The seal only requires normal door closing forces.*

**Location:** Door edges or door and window frames (user determined).

**Min/Max Gap:** Compression 1mm to 3mm.

**Fixing:** Push in locking fit into a 2.7mm x 6mm deep kerf groove.

**Seal:** Black TPE.

**Sizes:** Available in door set sizes or stock lengths.

### Approvals

**Fire** Flammability rating  $\leq 5$  when tested to AS1530.2.

**Smoke** NCC Spec. C3.4. AS1530.7 & BS EN 1634-3. Meets smoke leakage rates specified in AS6905 & EN 13501-2 "Sa", "Sm".

**Energy** NCC Pt. 3.12.3.3 & J3.4.

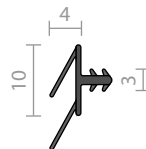

# Astragals

## Meeting Stile Seals

Astragal is a term used for the seal that seals the central joint between two swinging doors, the joint being known as the 'meeting stile'. A number of extra problems have to be faced when sealing a meeting stile. These include whether or not the seal will interfere with the centre latch, door closers, flush bolts and bottom seals.

### RP16Si



RP16Si is an acoustic, smoke astragal. Its proven design is effective in sealing the meeting stiles of plain or rebated double doors. Its aluminium trim neatly conceals the sealing portion of the seal and provides a secure weatherproof rebate stop. If necessary, its aluminium fixing leg can be checked out to allow for locks and latches.

For maximum acoustic performance, specify two seals, i.e. one for each door leaf. (Minimum door thickness subject to centre latch and dimensions of morticed door bottom seals).

RP16Si is used where one door leaf is active. For smoke door magnetic hold open applications such as hospital corridors, sequence select door closers are required.

**Location:** Meeting stiles of double butt hinged doors.

**Min/Max Gap:** 2.5mm to 8mm.

**Finish:** Satin clear (silver), bronze, black anodised aluminium (15µm) or paint at extra cost (page 7).

**Fixing:** Screw fix. Zinc plated, cross recess head CSK S.T. screws supplied. Can be rebated or surface mounted. Fixing holes are pre-drilled

**Seal:** RP316Si. Grey silicon rubber (SE).

**Sizes:** Available in stock lengths.

#### Approvals

ANSI/BHMA A156.22

**Acoustic AUS/NZ:** NCC Spec. F5.5.

**UK/EU:** Approved Document E. Rated to BS EN ISO 717.1.

**Fire** Gasket flammability index 1 when tested to AS1530.2.

**Smoke** NCC Spec. C3.4. AS1530.7 & BS EN 1634-3. Meets smoke leakage rates specified in AS6905 & EN 13501-2 "Sa", "Sm".

**Energy** NCC Pt. 3.12.3.3 & J3.4.

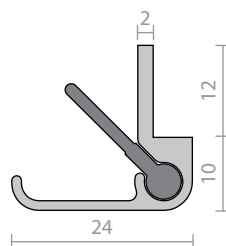

### RP37



A simple heavy duty 'T' section to provide security for meeting stiles.

**Location:** Meeting stiles of doors.

**Finish:** Satin clear (silver) anodised aluminium (15µm) or paint at extra cost (page 7).

**Fixing:** Screw fix. Zinc plated, cross recess head CSK S.T. screws supplied. Fixing holes are pre-drilled.

**Sizes:** Available in stock lengths.

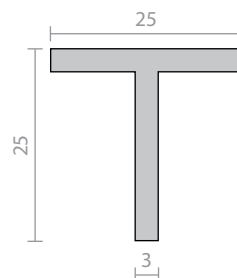

# Astragals

## Meeting Stile Seals



### RP71



An astragal seal designed for plain or rebated meeting stiles of timber double doors where a centre latch bolt may be required or, where both doors are active. The unique quiet fin of the RP71 is effective in acoustic and weather applications. Two RP71 seals are installed on to the one door stile which allows space for a latch between the two seals.

The legs of the seals can be checked out to accommodate the latch bolt front plate providing a continuous seal.

*Note: Minimum door thickness subject to centre latch and dimensions of morticed door bottom seals.*

**Location:** Meeting stiles of double butt hinged and centre pivot double acting doors.

**Min/Max Gap:** 3mm to 4mm.

**Finish:** Satin clear (silver), bronze anodised aluminium (15µm) or paint at extra cost (page 7).

**Fixing:** Screw fix. Colour matched zinc plated, cross recess head CSK S.T. screws supplied. Fixing holes are pre-drilled and countersunk.

**Seal:** Black polypropylene pile with felt weather fins.

**Sizes:** Available in stock lengths.

#### Approvals

**Acoustic AUS/NZ:** NCC Spec. F5.5.  
**UK/EU:** Approved Document E. Rated to BS EN ISO 717.1.

**Energy** NCC Pt. 3.12.3.3 & J3.4.

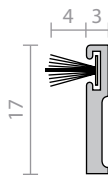

### RP71Si



A medium temperature smoke astragal seal designed for plain or rebated meeting stiles of timber double doors where a centre latch bolt may be required or, where both doors are active. The seal is achieved by a pair of silicon fins. Two RP71Si seals are installed on to the one door stile which allows space for a latch between the two seals.

The legs of the seals can be checked out to accommodate the latch bolt front plate providing a continuous seal.

*Note: Minimum door thickness subject to centre latch and dimensions of morticed door bottom seals.*

**Location:** Meeting stiles of double butt hinged and centre pivot double acting doors.

**Min/Max Gap:** 3mm to 5mm.

**Finish:** Satin clear (silver), bronze, black anodised aluminium (15µm) or paint at extra cost (page 7).

**Fixing:** Screw fix. Colour matched zinc plated, cross recess head CSK S.T. screws supplied. Fixing holes are pre-drilled and countersunk.

**Seal:** RP371Si. Grey silicon rubber (SE).

**Sizes:** Available in stock lengths.

#### Approvals

**Acoustic AUS/NZ:** NCC Spec. F5.5.  
**UK/EU:** Approved Document E. Rated to BS EN ISO 717.1.

**Fire** Gasket flammability index 1 when tested to AS1530.2.

**Smoke** NCC Spec. C3.4. AS1530.7 & BS EN 1634-3. Meets smoke leakage rates specified in AS6905 & EN 13501-2 "Sa", "Sm".

**Energy** NCC Pt. 3.12.3.3 & J3.4.

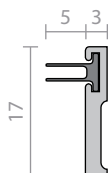



# Astragals

## Meeting Stile Seals for Frameless Glass



### RP42, RP103, RP104



Clear polycarbonate astragal and perimeter seals specifically designed for frameless glass doors. The woven pile sealing strip is combined with a weather fin to form an effective weather and energy seal.

Use in conjunction with Raven brush strip door bottom seals RP2b, RP74 and threshold plates.

#### Location:

**RP42** Meeting stiles of 15mm thick frameless glass doors.

**RP103** Meeting stiles of 10mm thick frameless glass doors.

**RP104** Meeting stiles of 12mm thick frameless glass doors.

**Min/Max Gap:** 7mm to 8mm (prior to installation).

**Fixing:** Self adhesive. *Note: Contact surface must be clean, smooth and if painted, well cured. Self adhesive seals will not adhere to oiled or alkyd finishes or to easy clean wash and wear paint surfaces.*

**Seal:** Clear high impact UV stabilised polycarbonate body with black polypropylene pile with weather fin.

**Sizes:** 3000mm.

#### Approvals

**Energy** NCC Pt. 3.12.3.3 & J3.4.

#### RP42

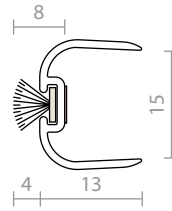

#### RP103

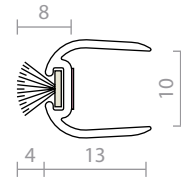

#### RP104

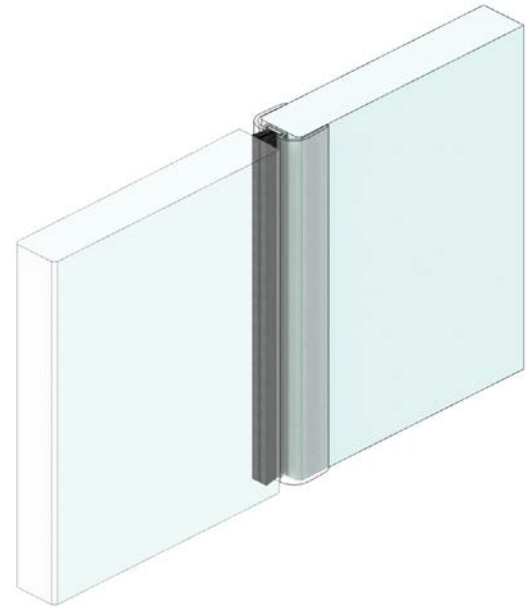
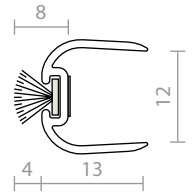

### RP79, RP79Si, RP79H, RP88



Aluminium astragal seals designed for frameless glass doors. The woven pile sealing strip in RP79 and RP88 is combined with a weather fin to form an effective weather and energy seal. RP79Si utilises silicon rubber fins for medium temperature smoke door applications.

Use in conjunction with Raven brush strip door bottom seals RP2b, RP74 and threshold plates.

#### Location:

**RP79, RP79Si, RP79H** Meeting stiles of 12mm thick frameless glass doors.

**RP88** Meeting stiles of 10mm thick frameless glass doors.

#### Min/Max Gap:

**RP79, RP79Si, RP88** 8mm to 9mm (prior to installation).

**RP79H** 8mm to 12mm (prior to installation).

**Finish:** Satin clear (silver) anodised aluminium (15µm).

**Fixing:** Self adhesive. *Note: Contact surface must be clean, smooth and if painted, well cured. Self adhesive seals will not adhere to oiled or alkyd finishes or to easy clean wash and wear paint surfaces.*

#### Seal:

**RP79, RP88** Black polypropylene pile with weather fin.

**RP79Si** RP371Si. Grey silicon rubber (SE).

**RP79H** RP640. Black TPE.

**Sizes:** Available in stock lengths.

#### Approvals

**Energy** NCC Pt. 3.12.3.3 & J3.4.



**Fire** Gasket flammability index 1 when tested to AS1530.2.

**Smoke** NCC Spec. C3.4 for smoke doors.



**Fire** Gasket flammability index ≤ 5 when tested to AS1530.2.

**Smoke** NCC Spec. C3.4 for smoke doors.

#### RP79

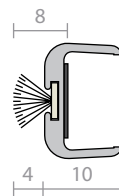

#### RP88

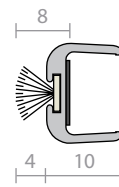

#### RP79Si

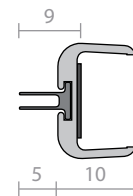

#### RP79H

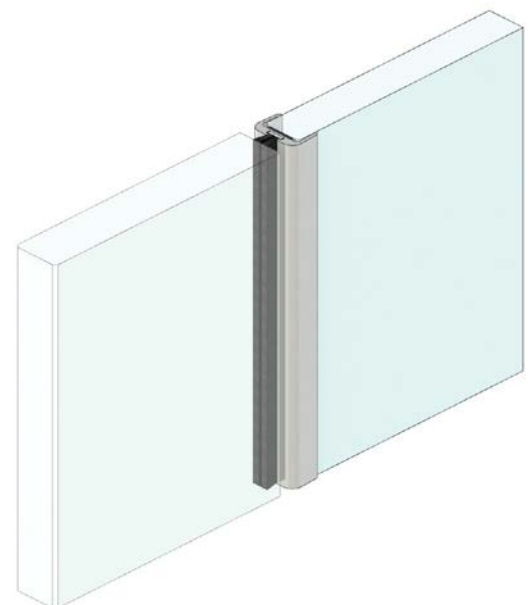
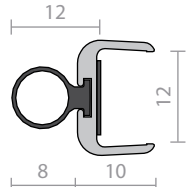

# Astragals

## Meeting Stile Seals for Glass Sliding Doors



### RP43Si



A medium temperature smoke seal that is designed to suit automatic sliding door operated, frameless glass and metal frame doors.

Comprising of two sealing sections, the RP43Si is fitted in an overlap configuration to effectively seal the vertical gap between the fixed and active sliding door leaf.

Can be used in conjunction with Raven brush strip door bottom seal RP74F, astragal seals RP79H, RP79Si and threshold plates.

**Location:** Automatic sliding door operated, frameless glass & metal frame doors

**Min/Max Gap:** 30mm to 50mm (prior to installation).

**Finish:** Satin clear (silver) anodised aluminium 15µm.

**Fixing:** Self adhesive.

**Seal:** RP343Si. Light grey silicon rubber (SE).

**Sizes:** Available in stock lengths.

#### Approvals

**Energy** NCC Pt. 3.12.3.3 & J3.4.

**Registered Design.**

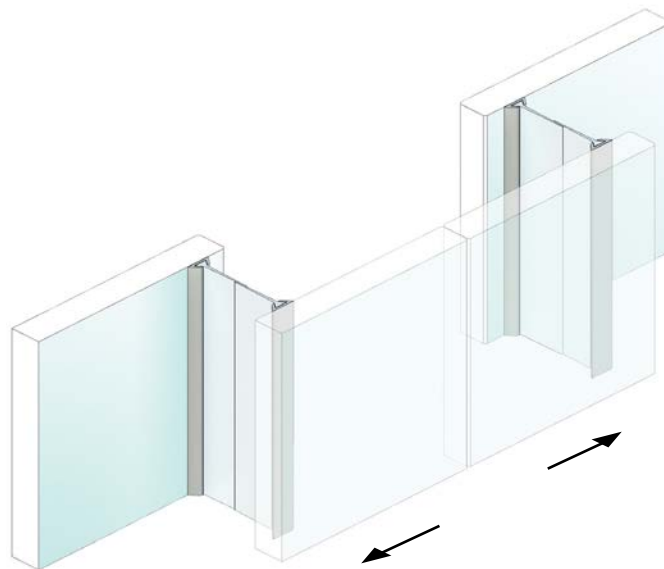
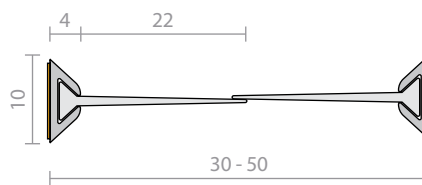

### RP105



A weather and energy seal that is designed to suit automatic sliding door operated, frameless glass and metal frame doors.

Comprising of two sealing sections, the RP105 is fitted in an overlap configuration to effectively seal the vertical gap between the fixed and active sliding door leaf.

Used in conjunction with Raven brush strip door bottom seal RP74F, astragal seals RP103, RP104, RP42 and Raven Threshold plates.

**Location:** Automatic sliding door operated, frameless glass & metal frame doors.

**Min/Max Gap:** 15mm to 28mm (prior to installation).

**Fixing:** Self adhesive.

**Seal:** Clear rigid and flexible co-polymer seal.

**Sizes:** Available in stock lengths.

#### Approvals

**Energy** NCC Pt. 3.12.3.3 & J3.4.

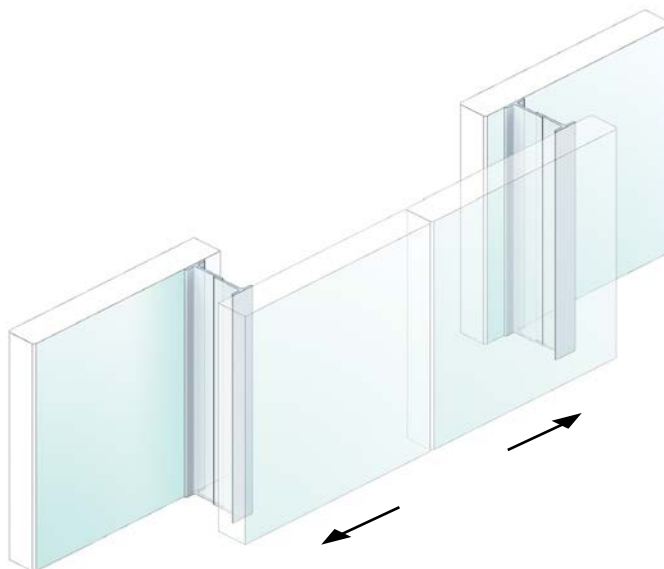
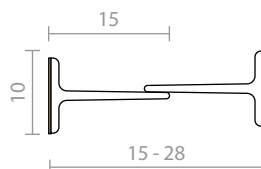

# Magnetic Astragals

## Magnetic Meeting Stile Seals

### RP39



A refrigeration type vinyl magnetic strip in an anodised aluminium housing. RP39 provides an astragal for timber and metal doors. The magnetic strip has sufficient closing strength that latches may not be required.

For perimeter seal applications, refer to [page 74](#).

*Note: As an astragal seal, RP39 is best suited to infrequent use and door closer hold open applications.*

**Location:** Head, jambs and stiles of single and double butt hinged doors, sliding doors or bulkhead applications. Butt hinges recommended.

**Min/Max Gap:** 4mm to 8mm (meeting stiles).

**Finish:** Satin clear (silver) anodised aluminium (15µm) or paint at extra cost ([page 7](#)).

**Fixing:** Screw fix. Zinc plated, cross recess head S.T. screws supplied. Fixing holes are slotted.

**Seal:** Black PVC.

**Sizes:** Available in stock lengths.

#### Approvals

**Energy** NCC Pt. 3.12.3.3 & J3.4.

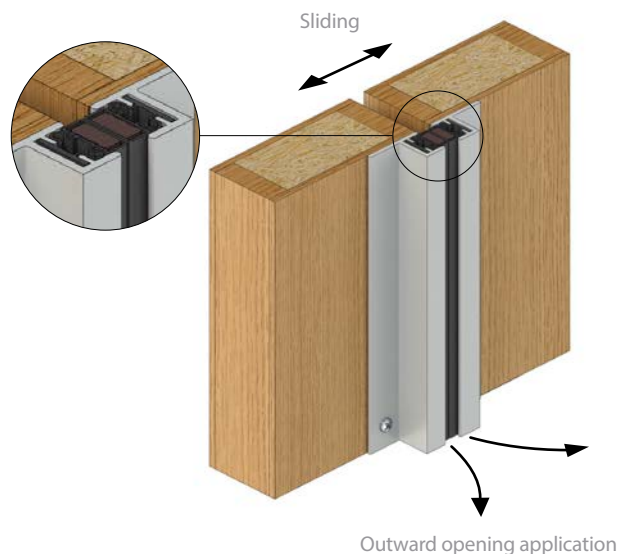
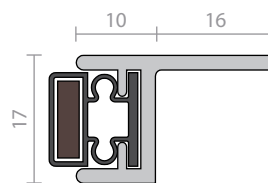

### RP65



A refrigeration type vinyl magnetic strip in an anodised aluminium channel which is morticed into the stiles of pivot, sliding or butt hinged double doors, to form an effective astragal. The magnetic strip is locked in place to prevent creeping and has sufficient strength that latches may not be required (centre latching can not be used).

Can be used in conjunction with Raven door bottom and perimeter seals.

*Note: RP65 is best suited to infrequent use and door closer hold open applications.*

**Location:** Meeting stiles of double swinging and sliding timber doors.

**Min/Max Gap:** 5mm to 7mm. (Swing doors).

**Finish:** Satin clear (silver) anodised aluminium (15µm).

**Fixing:** Push-in locking fit into a 16.5mm x 12mm deep groove and optional adhesive. Minimum door thickness of 40mm required.

**Seal:** Black PVC with magnetic strip.

**Sizes:** Available in stock lengths.

#### Approvals

**Energy** NCC Pt. 3.12.3.3 & J3.4.

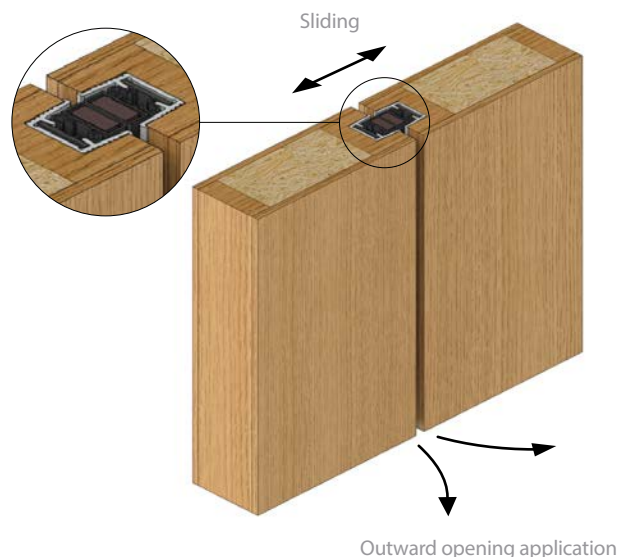
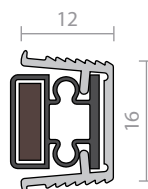

### Multi-use Products

<b>RP2b (brush only)</b> p.101 	<b>RP4T</b> p.51 	<b>RP26</b> p.52 	<b>RP51Si</b> p.53 
<b>RP73</b> p.77 	<b>RP85</b> p.79 	<b>RP120, RP150</b> p.82 	<b>RP121</b> p.99 
<b>RP122</b> p.99 	<b>RP124</b> p.83 	<b>RP130Si</b> p.83 	<b>RP134</b> p.84 



## Townsville Hospital Ensures Compliance With Raven

Raven supplied door bottom seals, perimeter seals and threshold plates for the Townsville Hospital project providing sealing systems that met a variety of sealing requirements. Raven seals were required to perform across multiple levels from the exclusion of fire, smoke and weather through to acoustic attenuation and the containment of energy.

Most projects, but particularly those in the healthcare industry require every component to meet strict regulations and standards and require certified testing to back this up. Raven's leading range of tested and certified sealing systems is why Raven sealing systems are chosen time and time again.

One of the biggest challenges for Raven on the Townsville Hospital project was accommodating the Bariatric Hoist System throughout the hospital. The rail system was installed on the ceiling passing through doorways, meaning Raven needed to deliver a sealing system to accommodate the hoist whilst ensuring a compliant and reliable performing system. Raven's extensive range coupled with its unequalled industry knowledge and expertise meant a sealing system was quickly designed in conjunction with the architect and builder to meet this requirement.

# Silicon Weather Stripping - RP500 Series



## Joinery Seals for Doors and Windows

Fitted into wooden kerf grooves, Raven silicon weather stripping can be used in all door and window joinery systems that require a premium quality, low closing force compression seal. Raven silicon weather stripping can also be used in aluminium and PVC proprietary systems where channel dimensions and clearances suit.

By the virtual elimination of compression set distortion (-60°C to +200°C), Raven silicon weather stripping increases life cycle sealing performance over traditional, plastic covered foam strips that may become hard and brittle. Raven silicon weather stripping has exceptional abrasion qualities that include improved resistance to UV, biological and chemical deterioration. When fitted correctly, Raven silicon weather stripping will not shrink and for ease of maintenance, can be removed and reused. This feature is well appreciated by painters and maintenance people.

Importantly, Raven silicon weather stripping offers improvements in air and rain infiltration performance, particularly where lower closing forces are required to meet new building regulations for energy efficiency and acoustic performance or where access and mobility is important.

*Note: For Bushfire Ember Attack refer Raven product selection table page 29.*



### Approvals

**Acoustic AUS/NZ:** NCC Spec. F5.5.

**UK/EU:** Approved Document E. Rated to BS EN ISO 717.1.

**Weather AUS/NZ:** NCC various sections. AS2047, AS4055, AS4420 Pt. 0 to 5 & AS/NZS 1170.

**UK/EU:** Approved Document L1 & L2. Tests above are similar to BS 5368 & BS 7386.

**Energy** NCC Pt. 3.12.3.3 & J3.4.

### RP500

**Location:** Aluminium, PVC or timber door and window frame grooves where dimensions suit.

**Compression:** 1mm to 3mm.

**Finish:** White, brown or black.

**Fixing:** Push-in locking fit into a 3mm x 6mm deep kerf groove.

**Sizes:** 100m, 24m.

**Approvals:** Acoustic, Weather & Energy.

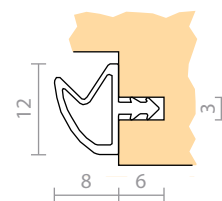

### RP510

**Location:** Aluminium, PVC or timber door and window frame grooves where dimensions suit.

**Compression:** 1mm to 2mm.

**Finish:** White, brown or black.

**Fixing:** Push-in locking fit into a 3.5mm x 5mm deep kerf groove.

**Sizes:** 100m, 24m.

**Approvals:** Acoustic, Weather & Energy.

Optional fitting detail

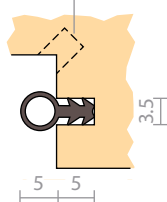

### RP520

**Location:** Aluminium, PVC or timber door and window frame grooves where dimensions suit.

**Compression:** 1mm to 3mm.

**Finish:** White, brown or black.

**Fixing:** Push-in locking fit into a 3.5mm x 5mm deep kerf groove.

**Sizes:** 100m, 24m.

**Approvals:** Acoustic, Weather & Energy.

Optional fitting detail

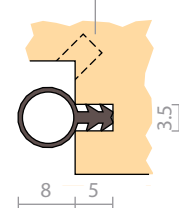

### RP530

**Location:** Aluminium, PVC or timber door and window frame grooves where dimensions suit.

**Compression:** 1mm to 2mm.

**Finish:** White, brown or black.

**Fixing:** Push-in locking fit into a 4mm x 6mm deep kerf groove.

**Sizes:** 50m, 24m.

**Approvals:** Acoustic, Weather & Energy.

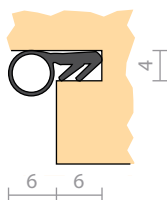

### RP540

**Location:** Proprietary aluminium or PVC door and window frame grooves where dimensions suit.

**Compression:** 1mm to 3mm.

**Finish:** Black.

**Fixing:** Slide fit into aluminium or rigid PVC groove where dimensions suit. (Channel not supplied).

**Sizes:** 100m, 24m.

**Approvals:** Energy.

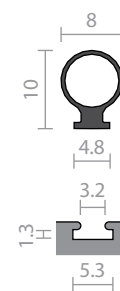

Recommended groove dimensions. Channel not supplied.

### RP550

**Location:** Aluminium, PVC or timber door and window frame grooves where dimensions suit.

**Compression:** 1mm to 3mm.

**Finish:** White, brown or black.

**Fixing:** Push-in locking fit into a 2.7mm x 6mm deep kerf groove.

**Sizes:** 100m, 24m.

**Approvals:** Weather & Energy.

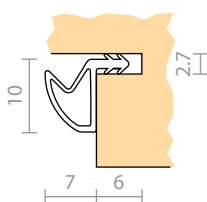

### RP560

**Location:** Aluminium, PVC or timber door and window frame grooves where dimensions suit.

**Compression:** 1mm to 3mm.

**Finish:** White, brown or black.

**Fixing:** Push-in locking fit into a 2.7mm x 6mm deep kerf groove.

**Sizes:** 100m, 24m.

**Approvals:** Weather & Energy.

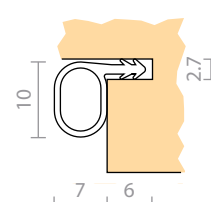

# TPE Weather Stripping - RP600 Series



## Joinery Seals for Doors and Windows

Fitted into wooden kerfs, Raven TPE weather stripping can be used in all door and window joinery systems that require a high quality, low closing force compression seal. Raven TPE weather stripping can also be used in aluminium and PVC proprietary systems where channel dimensions and clearances suit.

Raven TPE weather stripping increases life cycle sealing performance over traditional, plastic covered foam strips that may become hard and brittle. Raven TPE weather stripping also has exceptional abrasion qualities that include improved resistance to UV, biological and chemical deterioration. When fitted correctly, Raven TPE weather stripping will not shrink and has a compliant flammability rating  $\leq 5$  for use in bushfire prone areas. For ease of maintenance, Raven TPE weather strip can be removed and reused. This feature is well appreciated by painters and maintenance people. Importantly, Raven TPE weather stripping offers improvements in air and rain infiltration performance, particularly where lower closing forces are required to meet new building regulations for energy efficiency and acoustic performance or where access and mobility is important.

Note: For Bushfire *Ember Attack* refer Raven product selection table page 29.



### Approvals

**Fire** Flammability index  $\leq 5$  when tested to AS1530.2.

**Weather AUS/NZ:** NCC various sections. AS2047, AS4055, AS4420 Pt. 0 to 5 & AS/NZS 1170.

**UK/EU:** Approved Document L1 & L2. Tests above are similar to BS 5368 & BS 7386.

**Energy** NCC Pt. 3.12.3.3 & J3.4.

### RP600

**Location:** Aluminium, PVC or timber door and window frame grooves where dimensions suit.

**Compression:** 1mm to 3mm.

**Finish:** White, brown or black.

**Fixing:** Push in locking fit into a 3mm x 6mm deep kerf groove.

**Sizes:** 100m, 24m.

**Approvals:** Fire, Weather & Energy.

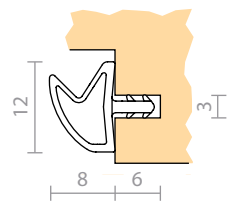

### RP610

**Location:** Aluminium, PVC or timber door and window frame grooves where dimensions suit.

**Compression:** 1mm to 2mm.

**Finish:** White, brown or black.

**Fixing:** Push in locking fit into a 3.5mm x 5mm deep kerf groove.

**Sizes:** 100m, 24m.

**Approvals:** Fire, Weather & Energy.

Optional fitting detail

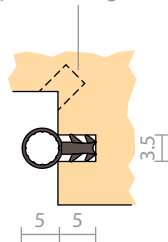

### RP620

**Location:** Aluminium, PVC or timber door and window frame grooves where dimensions suit.

**Compression:** 1mm to 3mm.

**Finish:** White, brown or black.

**Fixing:** Push in locking fit into a 3.5mm x 5mm deep kerf groove.

**Sizes:** 100m, 24m.

**Approvals:** Fire, Weather & Energy.

Optional fitting detail

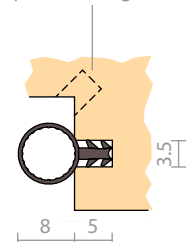

### RP630

**Location:** Aluminium, PVC or timber door and window frame grooves where dimensions suit.

**Compression:** 1mm to 2mm.

**Finish:** White, brown or black.

**Fixing:** Push in locking fit into a 4mm x 6mm deep kerf groove.

**Sizes:** 100m, 24m.

**Approvals:** Fire & Energy.

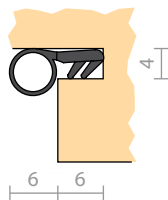

### RP640

**Location:** Proprietary aluminium or PVC door and window frame groove where dimensions suit.

**Compression:** 1mm to 3mm.

**Finish:** Black.

**Fixing:** Slide fit into aluminium or rigid PVC groove where dimensions suit. (Channel not supplied).

**Sizes:** 100m, 24m.

**Approvals:** Fire & Energy.

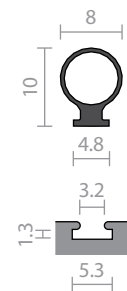

Recommended groove dimensions. Channel not supplied.

### RP650

**Location:** Aluminium, PVC or timber door and window frame grooves where dimensions suit.

**Compression:** 1mm to 3mm.

**Finish:** White, brown or black.

**Fixing:** Push in locking fit into a 2.7mm x 6mm deep kerf groove.

**Sizes:** 100m, 24m.

**Approvals:** Fire & Energy.

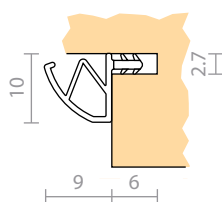

### RP660

**Location:** Aluminium, PVC or timber door and window frame grooves where dimensions suit.

**Compression:** 1mm to 3mm.

**Finish:** White, brown or black.

**Fixing:** Push in locking fit into a 2.7mm x 6mm deep kerf groove.

**Sizes:** 100m, 24m.

**Approvals:** Fire, Weather & Energy.

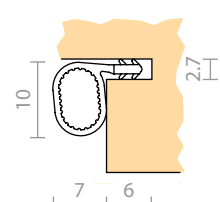

# TPE Weather Stripping - RP600 Series

Joinery Seals for Doors and Windows



## Approvals

**Fire** Flammability index  $\leq 5$  when tested to AS1530.2.

**Weather AUS/NZ:** NCC various sections. AS2047, AS4055, AS4420 Pt. 0 to 5 & AS/NZS 1170.

**UK/EU:** Approved Document L1 & L2. Tests above are similar to BS 5368 & BS 7386.

**Energy** NCC Pt. 3.12.3.3 & J3.4.

## RP680

**Location:** Proprietary aluminium or PVC door and window frame groove where dimensions suit.

**Compression:** 1mm to 3mm.

**Finish:** Black.

**Fixing:** Slide fit into aluminium or rigid PVC groove where dimensions suit. (Channel not supplied).

**Sizes:** 100m, 24m.

**Approvals:** Fire & Energy.

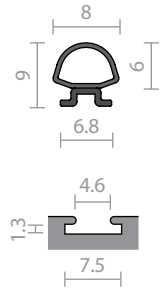

Recommended groove dimensions. Channel not supplied.

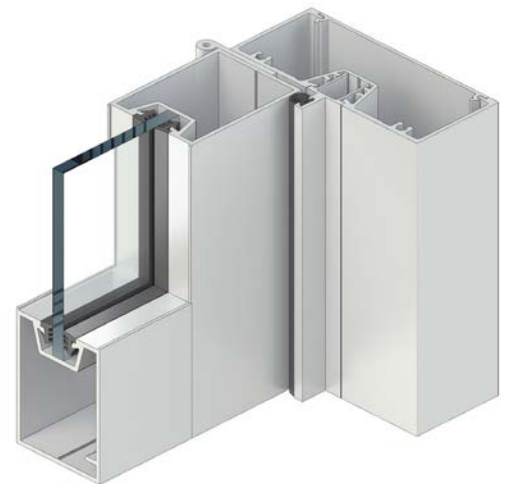

## Raven Seals Cut Energy Use by 50% !

David Saunders, architect of S2 Design designed and built his private home in metropolitan Melbourne, providing a best-practice example of environmentally aware and sustainable living.

With a focus on reducing energy consumption, Raven door and window seals were installed throughout the home to eliminate the loss of energy through gaps in doors and windows and to provide acoustic, weather and vermin protection.

David's home energy consumption is automatically monitored allowing David to see exactly how much energy the home is using at any time or over any period.

The energy consumption used to heat and cool the home was immediately reduced by 50% with the installation of Raven Door & Window seals that equated to a cost saving of over \$1,200 per year!

Raven Door & Window seals are a low cost and effective solution to an expensive problem; David found, the fitting of Raven seals to his home will pay for themselves in less than 2 years.

The seals below are superior quality, self-adhesive weather-strip seals for doors and windows. Quick and easy to install, they are DIY products which work well in eliminating draughts, rattles and cushioning applications.

## RP14



**Location:** Perimeter of doors and windows.

**Min/Max Gap:** 3mm to 5mm (user determined).

**Fixing:** Self adhesive. *Note: Contact surface must be clean, smooth and if painted, well cured.*

**Seal:** White or grey open cell urethane foam.

**Sizes:** 5m coil.

**Approvals:** Energy NCC Pt. 3.12.3.3 & J3.4.

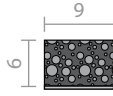

## RP14a



**Location:** Perimeter of doors and windows.

**Min/Max Gap:** 3mm to 5mm (user determined).

**Fixing:** Self adhesive. *Note: Contact surface must be clean, smooth and if painted, well cured.*

**Seal:** White or grey open cell urethane foam.

**Sizes:** 5m coil.

**Approvals:** Energy NCC Pt. 3.12.3.3 & J3.4.

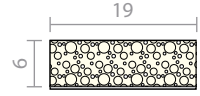

## RP14b



**Location:** Perimeter of doors and windows.

**Min/Max Gap:** 8mm to 11mm (user determined).

**Fixing:** Self adhesive. *Note: Contact surface must be clean, smooth and if painted, well cured.*

**Seal:** White open cell urethane foam.

**Sizes:** 2.5m coil.

**Approvals:** Energy NCC Pt. 3.12.3.3 & J3.4.

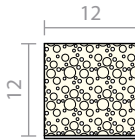

## RP61



**Location:** Perimeter of doors and windows.

**Min/Max Gap:** 3mm to 5mm (user determined).

**Fixing:** Self adhesive. *Note: Contact surface must be clean, smooth and if painted, well cured.*

**Seal:** Grey polypropylene.

**Sizes:** 5m coil.

**Approvals:** Energy NCC Pt. 3.12.3.3 & J3.4.

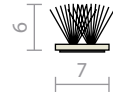

## RP48



**Location:** Perimeter of doors and windows.

**Min/Max Gap:** 3mm to 5mm (user determined).

**Fixing:** Self adhesive. *Note: Contact surface must be clean, smooth and if painted, well cured.*

**Seal:** White, brown or grey EPDM closed cell sponge.

**Sizes:** 5m coil pack (2 x 2.5m), jumbo reel (2 x 50m).

**Approvals:** Energy NCC Pt. 3.12.3.3 & J3.4.

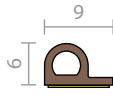

## RP59



**Location:** Perimeter of doors and windows.

**Min/Max Gap:** 2mm to 4mm (user determined).

**Fixing:** Self adhesive. *Note: Contact surface must be clean, smooth and if painted, well cured.*

**Seal:** White, brown or grey EPDM closed cell sponge.

**Sizes:** 5m coil pack (2 x 2.5m), jumbo reel (2 x 50m).

**Approvals:** Energy NCC Pt. 3.12.3.3 & J3.4.

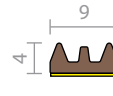

## RP108



**Location:** Multi-purpose (user determined).

**Min/Max Gap:** 6mm to 8mm (user determined).

**Fixing:** Self adhesive. *Note: Contact surface must be clean, smooth and if painted, well cured.*

**Seal:** White or grey EPDM closed cell sponge.

**Sizes:** 2m coil pack.

**Approvals:** Energy NCC Pt. 3.12.3.3 & J3.4.

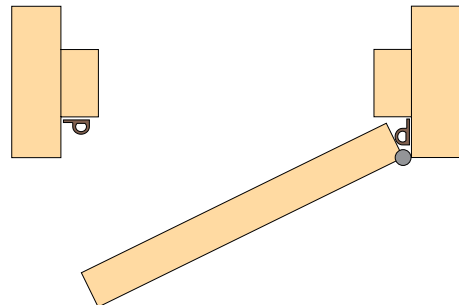
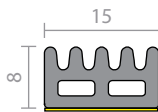



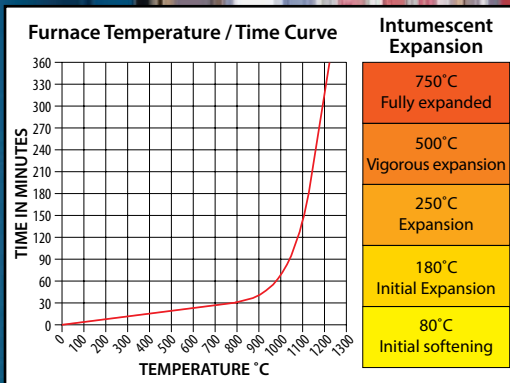

Raven has a large range of intumescent seals to suit the OEM and retrofit aftermarket. Intumescent seals are predominantly used in door assemblies manufactured by fire door manufacturers where they incorporate Raven sealing systems into the door set prior to leaving the factory.

Used in fire door assemblies of timber, steel or composite construction, Raven intumescent expands rapidly to many times its original size upon contact with fire. It concentrates high pressure in confined spaces, exfoliates slowly to protect itself once activated and has good insulation properties. When correctly positioned in the door leaf or door frame margin, the seals expand when activated to prevent the passage of flames, hot smoke and fumes from one compartment to another.

Unlike sodium silicate based material, Raven's unique intumescent is unaffected by water making them ideal for application in damp or humid environments. The intumescent is clean, non-toxic and displays outstanding durability and reliability.

Intumescent fire seals should be fitted as shown in the following typical examples.

### 30 Minute - Fire Rated FRL-/30/- and FD30

Single Door RP1004, RP76 or RP76Si, UK/EU RP1504 Seals.



Pair of doors with square meeting stiles RP1004, RP76 or RP76Si, UK/EU RP1504, RP2004, RP3004 or RP63 Seals.



Pair of doors with rebated meeting stiles RP1004, RP76 or RP76Si, UK/EU RP1504 Seals.

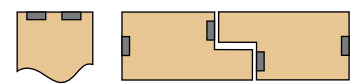

Pair of doors with rounded meeting stiles RP1004, RP76 or RP76Si, UK/EU RP1504 & RP2004, RP3004 or RP63.



Pair or single doors RP1004, RP76 or RP76Si seals UK/EU RP1504 seals. Fitted to head & jambs.

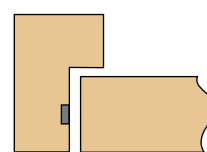

*Note: In meeting stiles where seals are opposite each other, always fit an intumescent pile/fin smoke seal opposite a plain intumescent seal.*

### 60 Minute - Fire Rated FRL-/60/- and FD60

Single door RP2004, RP3004 or RP63 for UK/EU 3004 seals.



Pair of doors with square meeting stiles RP2004, RP3004 or RP63 for UK/EU 3004 seals.



Pair of doors with rebated meeting stiles RP1004, UK/EU RP1504 seals.

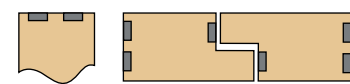

Pair of doors with rounded meeting stiles RP2004, RP3004 or RP63 for UK/EU 3004 seals.



Pair or single doors with RP2004, RP3004 or RP63 seals fitted to head & jambs for UK RP3004.

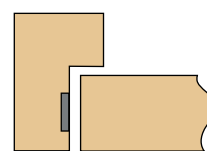

*Note: In meeting stiles where seals are opposite each other, always fit an intumescent pile/fin smoke seal opposite a plain intumescent seal.*

## RP1004, RP1504, RP2004, RP2504, RP3004



An intumescent fire seal enclosed in a rigid PVC casing for use on fire resisting doors and door frames. Available in a range of sizes, these intumescent seals are set into a morticed groove using an adhesive backing tape.

**Location:** Morticed into the door frame and around stiles and head.

**Finish:** Brown or white rigid PVC holder with intumescent infill.

**Fixing:** Self adhesive. *Note: Contact surface must be clean, smooth and if painted, well cured. Self adhesive seals will not adhere to oiled or alkyd finishes or to easy clean wash and wear paint surfaces.*

**Sizes:** 2100mm.

### Approvals

**Fire & Smoke AUS/NZ:** NCC Spec. C3.4 for fire doors. AS1530.4 & AS/NZS 1905.1. NZ BC Compliance Doc. C/AS1 6.19.2(a) & App. C6.1.1.  
**UK/EU:** Approved Document B. BS 476 Pt. 20 & 22, BS EN 1634-1. Certifier UK Approved.

### RP1004

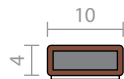

FRL & FRR-/30/- and FD30.

### RP1504

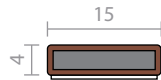

FRL & FRR-/30/- and FD30.

### RP2004

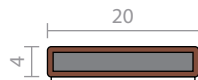

FRL & FRR-/60/- and FD60.

### RP2504

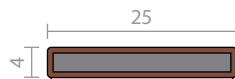

FRL & FRR-/60/- and FD60.

### RP3004

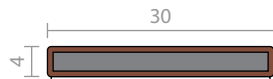

FRL & FRR-/60/- and FD60.

## RP1004F, RP2004F



An intumescent fire seal enclosed in a PVC casing for use on fire resisting doors and door frames. Set into a morticed groove using an adhesive backing tape, the RP1004F and RP2004F are ideal to upgrade perimeter door frame margins that exceed the 3mm gap of compliance on proprietary fire doors. Supplied coiled to minimise wastage when cutting to exact size.

**Location:** Morticed into the door frame and around stiles and head.

**Finish:** Brown or white flexible PVC holder with intumescent infill.

**Fixing:** Self adhesive. *Note: Contact surface must be clean, smooth and if painted, well cured. Self adhesive seals will not adhere to oiled or alkyd finishes or to easy clean wash and wear paint surfaces.*

### Sizes:

**RP1004F** 150m coil.

**RP2004F** 100m coil.

### Approvals

**Fire & Smoke AUS/NZ:** NCC Spec. C3.4 for fire doors. AS1530.4 & AS/NZS 1905.1. NZ BC Compliance Doc. C/AS1 6.19.2 & App. C6.1.1.  
**UK/EU:** Approved Document B. BS 476 Pt. 20 & 22 (similar to BS EN 1634-1).

### RP1004F

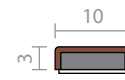

FRL & FRR-/60/- and FD60.

### RP2004F

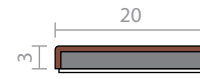

FRL & FRR-/120/30 and FD120.

## RP1004S, RP1504S, RP2004S



An intumescent fire seal enclosed in a rigid PVC casing set into a morticed groove for use on fire resisting doors and door frames. Incorporating a polypropylene pile smoke seal and fin barrier.

**Location:** Morticed into the door frame and around stiles and head.

**Min/Max Gap:** 3mm to 4mm.

**Finish:** Brown or white rigid PVC holder with intumescent infill.

**Fixing:** Self adhesive. *Note: Contact surface must be clean, smooth and if painted, well cured. Self adhesive seals will not adhere to oiled or alkyd finishes or to easy clean wash and wear paint surfaces.*

**Seal:** Polypropylene pile and fin.

**Sizes:** 2100mm.

### Approvals

**Acoustic AUS/NZ:** NCC Spec. F5.5.  
**UK/EU:** Approved Document E. Rated to BS EN ISO 717.1.  
**Fire & Smoke AUS/NZ:** NCC Spec. C3.4 for fire doors. AS1530.4 & AS/NZS 1905.1. NZ BC Compliance Doc. C/AS1 6.19.2(a) & App. C6.1.1.  
**UK/EU:** Approved Document B. BS

476 Pt. 20&22 similar to BS EN 1634-1). Certifier UK Approved.

**Energy** NCC Pt. 3.12.3.3 & J3.4.

### RP1004S

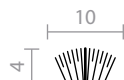

FRL & FRR-/120/30 and FD120.

### RP1504S

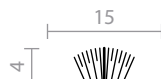

FRL & FRR-/60/- and FD60.

### RP2004S



FRL & FRR-/120/30 and FD120.

## RP1004SA, RP2004SA, RP3004SA



An intumescent fire seal enclosed in a rigid PVC casing set into a morticed groove for use on fire resisting doors and door frames. Incorporating a PVC smoke seal.

**Location:** Morticed into the door frame and around stiles and head.

**Min/Max Gap:** 1mm to 4mm.

**Finish:** Brown or white rigid PVC holder with intumescent infill.

**Fixing:** Self adhesive. *Note: Contact surface must be clean, smooth and if painted, well cured. Self adhesive seals will not adhere to oiled or alkyd finishes or to easy clean wash and wear paint surfaces.*

**Seal:** PVC fin seal.

**Sizes:** 2100mm.

### Approvals

**Acoustic AUS/NZ:** NCC Spec. F5.5.  
**UK/EU:** Approved Document E. Rated to BS EN ISO 717.1.  
**Fire & Smoke AUS/NZ:** NCC Spec. C3.4 for fire doors. AS1530.4 & AS/NZS 1905.1. NZ BC Compliance Doc. C/AS1 6.19.2(a) & App. C6.1.1.  
**UK/EU:** Approved Document B. BS 476 Pt. 20 & 22, BS EN 1634-1. Certifier UK Approved.  
**Energy** NCC Pt. 3.12.3.3 & J3.4.

### RP1004SA

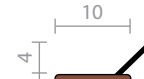

FRL & FRR-/120/30 and FD120.

### RP2004SA



FRL & FRR-/120/30 and FD120.

### RP3004SA

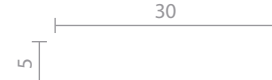

FRL & FRR-/60/- and FD60.



## RP53



An intumescent seal in a PVC holder which is ideal for upgrading proprietary door perimeter gaps where the clearance exceeds the maximum 3mm as specified by AS1905.1.

When exposed to heat, the seal expands to fill in the gap.

Use in conjunction with Raven Si rated door bottom smoke seals or brush strip seals for pivot doors.

**Location:** Door or frame stiles and head.

**Min/Max Gap:** 2mm to 6mm.

**Finish:** Brown, grey or white flexible PVC holder with intumescent infill. Can be painted.

**Fixing:** Self adhesive.

*Note: Contact surface must be clean, smooth and if painted, well cured. Self adhesive seals will not adhere to oiled or alkyd finishes or to easy clean wash and wear paint surfaces.*

**Sizes:** 3000mm, 2100mm.

### Approvals

Cert. GVI.R37913.

**Fire & Smoke AUS/NZ:** NCC Spec. C3.4 for fire doors. AS1530.4 & AS/NZS 1905.1. NZ BC Compliance Doc. C/AS1 6.19.2(a) & App. C6.1.1. **FRL & FRR-/120/30 and FD120.**  
**UK/EU:** Approved Document B. BS 476 Pt. 20 & 22 (similar to BS EN 1634-1).

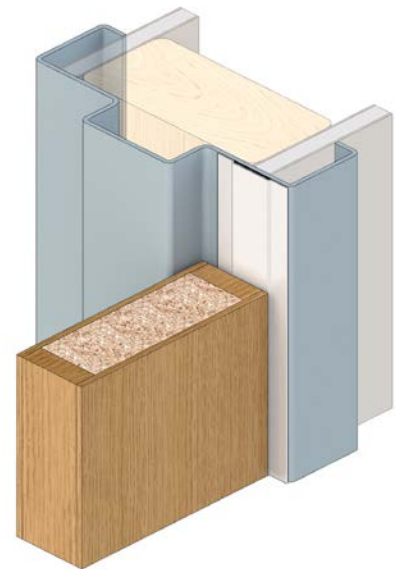

## RP63



A combined intumescent medium temperature smoke and fire seal which is heat activated. It is unobtrusively set into a machined groove around the perimeter of timber frames and door edges. The RP63 comes in a variety of trim selections and can be checked out in the latch area to allow for the continuation of the fin.

An effective medium temperature smoke seal is achieved with a pair of silicon fins between the door and frame.

**Location:** Morticed into the door frame and around stiles and head.

**Min/Max Gap:** 3mm to 4mm.

**Finish:** Satin clear (silver) anodised aluminium (15µm). Trim available in antique white, American oak, teak or rosewood finishes.

**Fixing:** Adhesive fix into a 30mm x 7mm groove.

**Seal:** RP371Si. Grey silicon rubber (SE) with intumescent infill.

**Sizes:** 2400mm, 2100mm.

### Approvals

**Fire AUS/NZ:** NCC Spec. C3.4. AS1530.4 & AS/NZS 1905.1. NZ BC Compliance Doc. C/AS1 6.19.2 & App. C6.1.1.

**UK/EU:** Approved Document B. (Tests above are similar to BS EN 1634-1 & BS 476 Pt. 20 & 22).

**FRL & FRR-/180/30 and FD180.**

**Smoke** NCC Spec. C3.4. AS1530.7 & BS EN 1634-3. Meets smoke leakage rates specified in AS6905 & EN 13501-2 "Sa", "Sm".

**Energy** NCC Pt. 3.12.3.3 & J3.4.

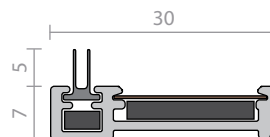

Antique white



Teak



American Oak



Rosewood

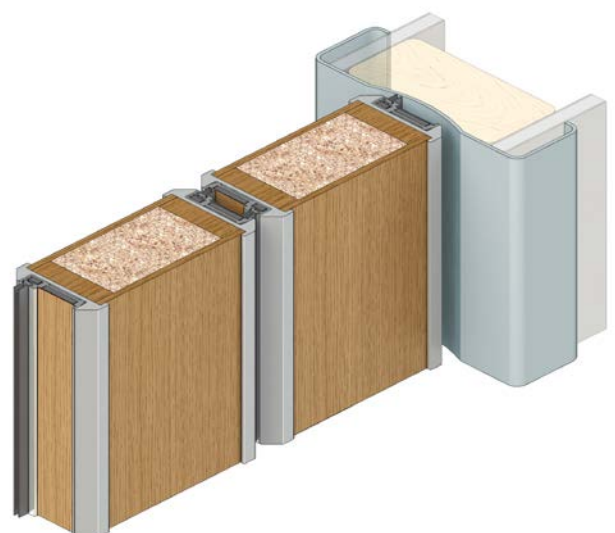

## RP76, RP76Si



Combined intumescent smoke and fire seals which are heat activated. It is unobtrusively set into a machined groove (10x6mm) around the perimeter of timber frame or door edges. Dependent on application, fire ratings of one to four hours have been certified by fire door manufacturers using RP76 and RP76Si intumescent fire and smoke seals.

RP76 utilises a woven pile polypropylene ambient (cold) smoke seal.

RP76Si utilises a pair of silicon fins to achieve a medium temperature smoke seal.

**Location:** Morticed into the door frame and around stiles and head.

### Min/Max Gap:

**RP76** 3mm to 4mm.

**RP76Si** 4mm to 5mm.

**Finish:** Cranberry red rigid PVC holder with intumescent infill.

**Fixing:** Self adhesive into a 10mm x 6mm groove. *Note: Contact surface must be clean, smooth and if painted, well cured.*

### Seal:

**RP76** Polypropylene pile ambient temperature smoke seal.

**RP76Si** RP371Si. Grey silicon rubber (SE) medium temperature smoke seal.

**Sizes:** 2100mm.

### Approvals

**Fire & Smoke AUS/NZ:** NCC Spec. C3.4. AS1530.4 & AS/NZS 1905.1. NZ BC Compliance Doc. C/AS1 6.19.2(a) & App. C6.1.1.

**UK/EU:** Approved Document B. (Tests above are similar to BS EN 1634-1 & BS 476 Pt. 20 & 22).

**FRL & FRR-/240/60 and FD240.** 🔥

**Energy** NCC Pt. 3.12.3.3 & J3.4.

### RP76Si M200°C

**Fire** Gasket flammability index 1 when tested to AS1530.2.

**Smoke** NCC Spec. C3.4. AS1530.7 & BS EN 1634-3. Meets smoke leakage rates specified in AS6905 & EN 13501-2 "Sa", "Sm".

## RP76

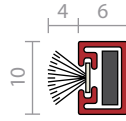

## RP76Si

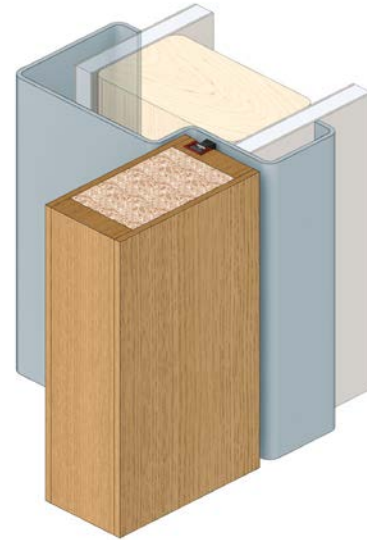
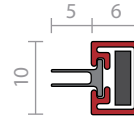

## RP114



RP114 is a door bottom intumescent fire and hot smoke seal that is designed to salvage non-compliant fire doors where clearances exceed 10mm under fire doors as per AS/NZS 1905.1.

The simple retrofit design avoids costly door replacement and the need to remove the door during installation.

RP114 is approved for use on leading proprietary fire doors.

*Note: RP114 should just clear the floor during door opening and closing. To avoid the seal fouling on uneven or sloping surfaces, the finned gasket portion should engage an approved Raven threshold plate. This will enhance the other icon sealing functions.*

**Location:** Bottom of fire and smoke doors.

**Min/Max Gap:** 14mm to 20mm (without threshold plate).

**Finish:** Satin clear (silver) or bronze anodised aluminium (15 µm).

**Fixing:** Screw fix. Zinc plated, cross recess head S.T. screws supplied.

**Seal:** Intumescent infill, grey flexible PVC (SE) cover strip and finned gasket.

**Sizes:** 1220mm, 915mm, 820mm.

### Approvals

**Fire AUS/NZ:** NCC Spec. C3.4 for fire doors. AS1530.4 & AS/NZS 1905.1. NZ BC Compliance Doc. C/AS1 6.19.2(a) & App. C6.1.1.

**UK/EU:** Approved Document B. (Tests above are similar to BS EN 1634-1 & BS 476 Pt. 20 & 22).

**FRL & FRR-/240/60 and FD240.** 🔥

**Energy** NCC Pt. 3.12.3.3 & J3.4.

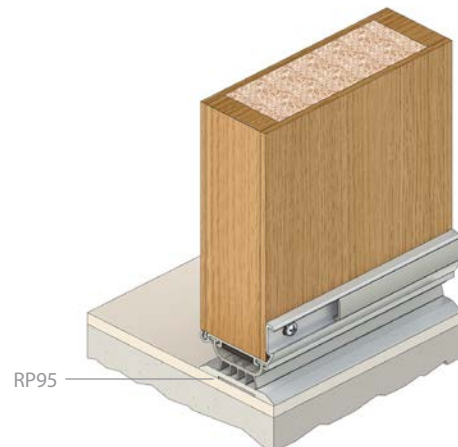
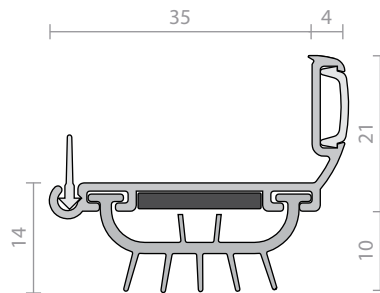

## RP121



An effective fire, smoke and acoustic seal designed for single action fire doors. The RP121 is a twin section bullnose T bar aluminium astragal seal with an intumescent infill and smoke seal.

**Location:** Meeting stiles of pairs of 47mm nominal thickness single action fire doors.

**Min/Max Gap:** 13mm to 16mm (prior to installation).

**Finish:** Satin clear (silver) anodised aluminium (15µm).

**Fixing:** Screw fix. Zinc plated, cross recess head CSK S.T. screws supplied.

**Seal:** Concealed intumescent infill and RP124 smoke seal.

**Sizes:** Available in stock lengths.

### Approvals

**Smoke** NCC Spec. C3.4. AS1530.7 & BS EN 1634-3. Meets smoke leakage rates specified in AS6905 & EN 13501-2 "Sa", "Sm".

**Energy** NCC Pt. 3.12.3.3 & J3.4.

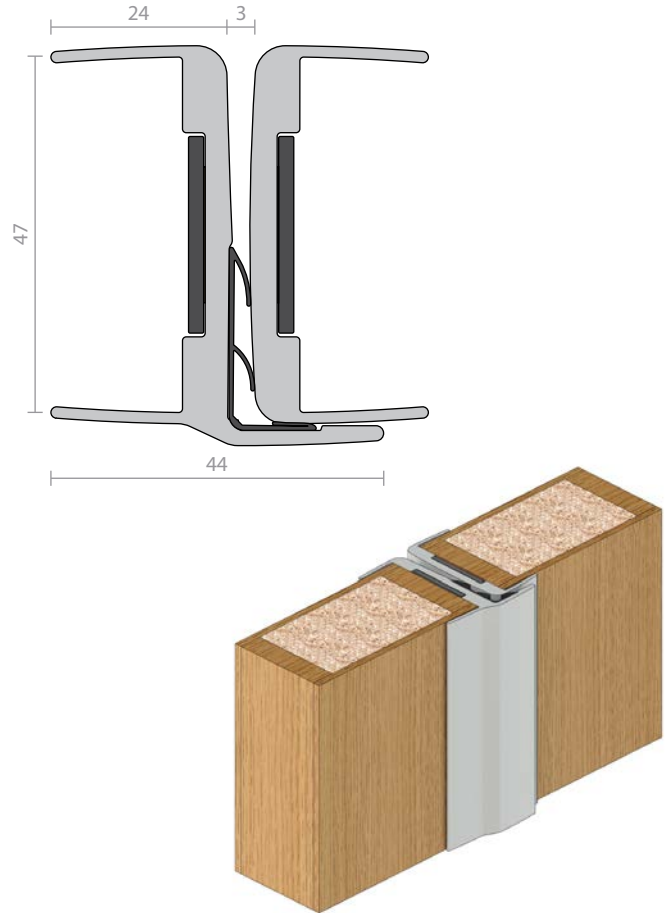

## RP122



An effective fire, smoke and acoustic seal designed for double action fire doors. With concealed fixings, the RP122 is a twin section aluminium bullnose astragal seal with an intumescent infill and PVC fin smoke seal.

**Location:** Meeting stiles of pairs of 47mm nominal thickness double action fire doors.

**Min/Max Gap:** 13mm to 15mm (prior to installation).

**Finish:** Satin clear (silver) anodised aluminium (15µm).

**Fixing:** Concealed screw fix. Zinc plated, cross recess head CSK S.T. screws supplied. Self adhesive intumescent infill.

**Seal:** Light grey rigid PVC case with intumescent infill and PVC sealing fins.

**Sizes:** Available in stock lengths.

### Approvals

**Fire AUS/NZ:** NCC Spec. C3.4. AS1530.4 & AS/NZS 1905.1. NZ BC Compliance Doc. C/AS1 6.19.2 & App. C6.1.1.

**UK/EU:** Approved Document B. BS 476 Pt. 20 & 22 (similar to BS EN 1634-1).

**FRL & FRR-/120/30 and FD120.** 🔥

**Energy** NCC Pt. 3.12.3.3 & J3.4.

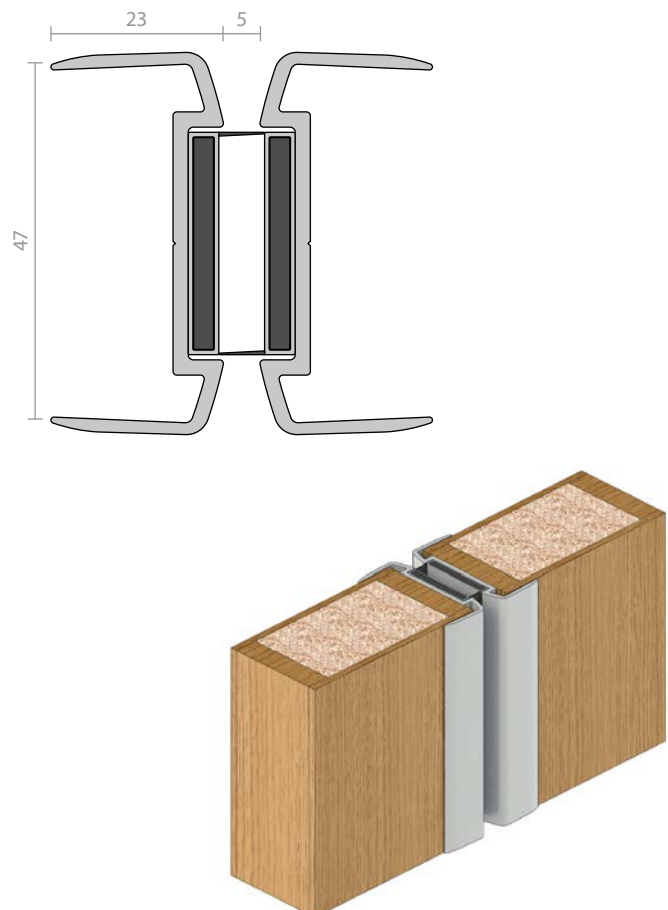



# Brush Strip Seals

## Nylon Filament



The versatility of Raven brush strip seals and ease of installation makes them particularly suitable for sealing difficult applications such as sliding, revolving, pivot, roll-up and panel lift doors. Suitable for protection against smoke, draughts, light, dust, insects, bushfire embers and for energy retention, Raven nylon brush strips are ideal for heavy duty applications with tests proving minimal wear occurs over prolonged use.

Dense black nylon bristles are locked into a galvanised steel spine which is often fitted into an anodised aluminium holder. Raven brush strips are also available without the aluminium holders. Specify for example RP57 (brush only). Adhesive tape is standard on most holders for ease of installation.

Raven use special nylon filament due to its significantly superior performance over inferior materials such as polypropylene. Withstanding temperatures up to 200°C for 30 minutes, Raven brush strips are self-extinguishing and can be used as a bushfire ember seal, up to BAL FZ for garage doors. Product selection should be made when assessing the mandated requirements of the NCC and Australian Bushfire Standard AS 3959.

### RP2, RP2b (brush only)



Nylon brush strip seals without holder, that are fitted in a concealed manner into a machined groove in a door.

Where a small clearance is encountered, the groove should be double morticed to allow the brush to flex.

**Location:** Stiles or bottom of single, double, sliding and double acting timber doors.

#### Min/Max Gap:

**RP2** up to 19mm (user determined).

**RP2b (brush only)** up to 13mm (user determined).

**Fixing:** Inserted into morticed groove (optional adhesive if required). Where a small clearance is encountered, the groove should be double morticed to allow the brush to flex.

**Seal:** Black fine, dense, UV stabilised nylon filaments secured in a galvanised steel spine.

**Sizes:** Available in stock lengths.

#### Approvals

**Energy** NCC Pt. 3.12.3.3 & J3.4.

#### RP2

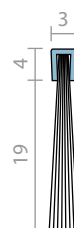

#### RP2b (brush only)

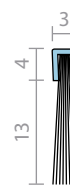

Single mortice for large gaps

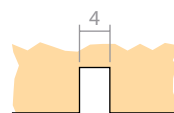

Double morticed for small gaps

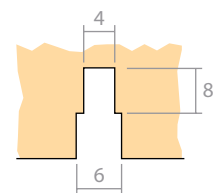

Perimeter Seals

# Brush Strip Seals

## Nylon Filament



### RP2a



A nylon brush strip seal with an anodised aluminium carrier that mounts to the inside or outside of a door. It is ideal for sliding or double acting doors.

Can be concealed inside of an aluminium door suite bottom rail by the fabricator.

Used in conjunction with Raven threshold plates.

**Location:** Bottom of single, double, sliding and double acting doors.

**Min/Max Gap:** Up to 19mm (user determined).

**Finish:** Satin clear (silver), bronze anodised aluminium (15µm) or paint at extra cost (page 7).

**Fixing:** Self adhesive or can be screw fixed. *Note: Contact surface must be clean, smooth and if painted, well cured. Self adhesive seals will not adhere to oiled or alkyd finishes or to easy clean wash and wear paint surfaces.*

**Seal:** Black fine, dense, UV stabilised nylon filaments.

**Sizes:** Available in stock lengths.

#### Approvals

**Energy** NCC Pt. 3.12.3.3 & J3.4.

BAL when used on a garage in accordance with AS 3959.

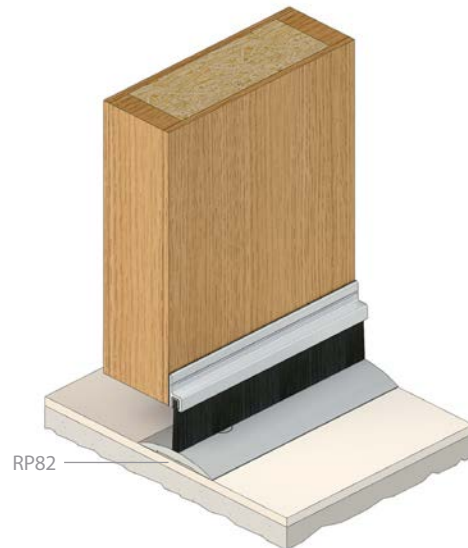
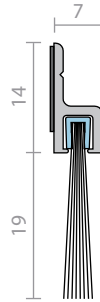

### RP2b



A nylon brush strip seal with an anodised aluminium carrier that mounts to the inside or outside of a door.

Used in conjunction with Raven threshold plates.

**Location:** Bottom of single, double or sliding doors.

**Min/Max Gap:** Up to 13mm (user determined).

**Finish:** Satin clear (silver), bronze anodised aluminium (15µm) or paint at extra cost (page 7).

**Fixing:** Self adhesive or can be screw fixed. *Note: Contact surface must be clean, smooth and if painted, well cured. Self adhesive seals will not adhere to oiled or alkyd finishes or to easy clean wash and wear paint surfaces.*

**Seal:** Black fine, dense, UV stabilised nylon filaments.

**Sizes:** Available in stock lengths.

#### Approvals

**Energy** NCC Pt. 3.12.3.3 & J3.4.

BAL when used on a garage in accordance with AS 3959.

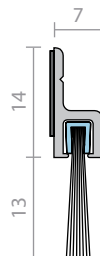



# Brush Strip Seals

## Nylon Filament

### RP15



A nylon brush strip seal with aluminium carrier that is ideal where larger gaps are encountered.

Used in conjunction with Raven threshold plates.

**Location:** Bottom of single, double or sliding doors.

**Min/Max Gap:** Up to 25mm (user determined).

**Finish:** Satin clear (silver), bronze anodised aluminium (15µm) or paint at extra cost (page 7).

**Fixing:** Self adhesive or can be screw fixed. *Note: Contact surface must be clean, smooth and if painted, well cured. Self adhesive seals will not adhere to oiled or alkyd finishes or to easy clean wash and wear paint surfaces.*

**Seal:** Black fine, dense, UV stabilised nylon filaments.

**Sizes:** Available in stock lengths.

#### Approvals

**Energy** NCC Pt. 3.12.3.3 & J3.4.

**BAL ≤FZ** when used on a garage in accordance with AS 3959.

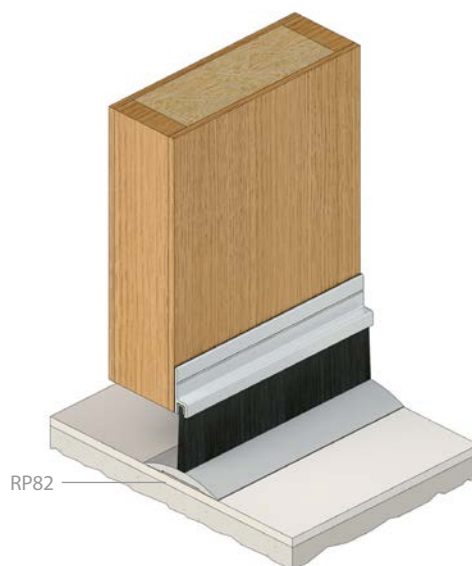
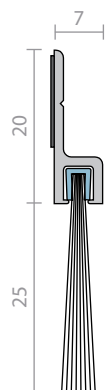

### RP41



A nylon brush strip seal with aluminium carrier that is ideal where larger gaps are encountered. The RP41 can be fitted to lintels of roll-up doors to help prevent the ingress of birds and wind blown embers in bushfire prone areas.

*Note: Roll-up doors must have a fairly constant sealing gap when the door operates to avoid excessive flexing of brush filament.*

**Location:** Bottom of single, double, revolving or sliding and double acting pivot doors. Lintels of roll-up garage doors or lintels and stiles of panel-lift garage doors.

**Min/Max Gap:** 30mm to 50mm (user determined).

**Finish:** Satin clear (silver) anodised aluminium (15µm).

**Fixing:** Screw fix. Zinc plated, cross recess head S.T. screws supplied.

**Seal:** Black fine, dense, UV stabilised nylon filaments.

**Sizes:** Available in stock lengths.

#### Approvals

**Energy** NCC Pt. 3.12.3.3 & J3.4.

**BAL ≤FZ** when used on a garage in accordance with AS 3959.

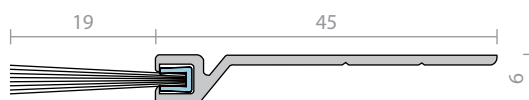

# Brush Strip Seals

## Nylon Filament



### RP49, RP50



Versatile nylon brush strip seals with angled aluminium carriers. The RP49 has a 90 degree angle and the RP50 has a 45 degree angle.

#### Location:

**RP49** Frame or stiles of sliding doors (user determined).

**RP50** Panel lift doors (user determined).

**Finish:** Satin clear (silver), bronze anodised aluminium (15µm) or paint at extra cost (page 7).

**Fixing:** Self adhesive or can be screw fixed. *Note: Contact surface must be clean, smooth and if painted, well cured. Self adhesive seals will not adhere to oiled or alkyd finishes or to easy clean wash and wear paint surfaces.*

**Seal:** Black fine, dense, UV stabilised nylon filaments.

**Sizes:** Available in stock lengths.

#### Approvals

**Energy** NCC Pt. 3.12.3.3 & J3.4.  
BAL  $\leq 29$  when used on a garage in accordance with AS 3959.

### RP49

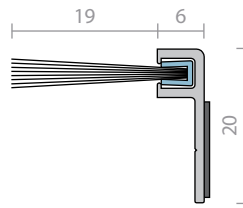

### RP50

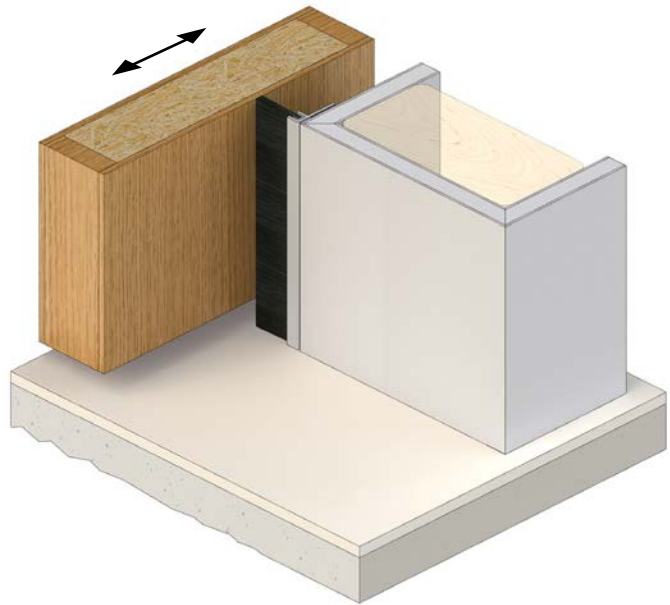
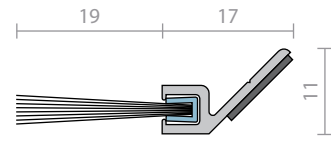

### RP51F



RP51F is a patented brush strip seal that is ideal for sealing the head, jambs and the bottom of automatic sliding doors. The RP51F nylon brush contains an additional barrier fin which is effective in the exclusion of medium temperature smoke, noise and weather.

**Location:** Head, jambs and bottom of automatic sliding doors.

**Min/Max Gap:** Up to 13mm (user determined).

**Finish:** Satin clear (silver) anodised aluminium (15µm).

**Fixing:** Concealed screw fix. Zinc plated, cross recess head S.T. screws and cover strip supplied. Fixing holes are pre-slotted.

**Seal:** Black fine, dense, UV stabilised nylon filaments with a medium temperature smoke barrier fin within a galvanised spine.

**Sizes:** Available in stock lengths.

#### Approvals

**Smoke** AS 1530.7. AS 6905.  
EN 1634-3. NCC Spec. C3.4 for smoke doors.

**Energy** NCC Pt. 3.12.3.3 & J3.4.  
BAL  $\leq 29$  when used on a garage in accordance with AS 3959.

#### Innovation Patent.

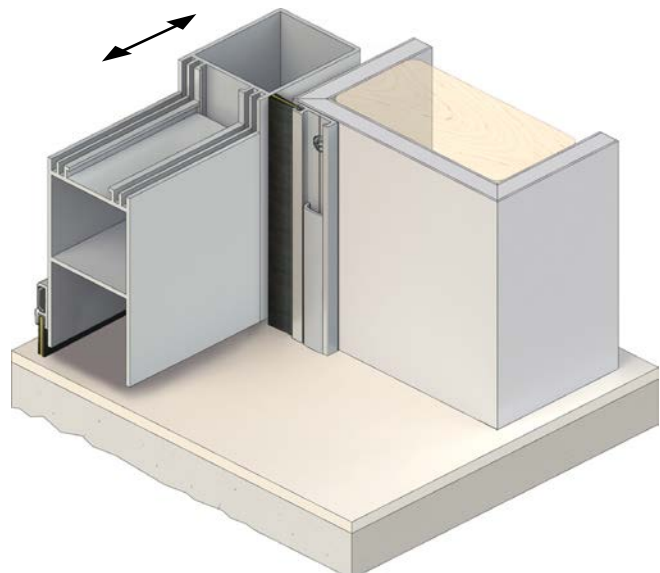
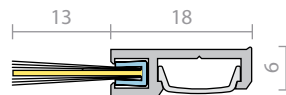

# Brush Strip Seals

## Nylon Filament



### RP52F



A nylon brush strip without holder, that is fitted in a concealed manner into a machined groove in a door. Where a small clearance is encountered, the groove should be double morticed to allow the brush and fin to flex. The brush houses a unique medium temperature fin, which is effective in the sealing of medium temperature smoke, noise and weather.

**Location:** Stiles or bottoms of single, double, sliding or double acting doors.

**Min/Max Gap:** Up to 13mm (user determined).

**Fixing:** Inserted into morticed groove (optional adhesive if required). Where a small clearance is encountered, the groove should be double morticed to allow the brush to flex.

**Seal:** Black fine, dense, UV stabilised nylon filaments with a medium temperature smoke barrier fin within a galvanised spine.

**Sizes:** Available in stock lengths.

#### Approvals

**Smoke** AS1530.7. AS6905.

**Energy** NCC Pt. 3.12.3.3 & J3.4.

**BAL ≤FZ** when used on a garage in accordance with AS 3959.

**Patented.**

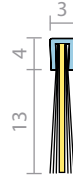

Single mortice for large gaps

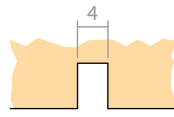

Double morticed for small gaps

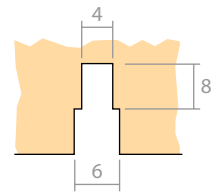

### RP57, RP58



Nylon brush strip seals with aluminium carriers that are ideal where larger gaps are encountered. They can be fitted to lintels of roll-up doors to help prevent the ingress of birds and wind blown embers in bushfire prone areas.

*Note: Roll-up doors must have a fairly consistent gap when the door operates to avoid excessive flexing of the seal.*

**Location:** Bottom of single, double, revolving or sliding doors and double acting pivot doors. Lintels of roll-up garage doors.

#### Min/Max Gap:

**RP57** 30mm to 50mm (user determined).

**RP58** 50mm to 75mm (user determined).

#### Finish:

**RP57** Satin clear (silver), bronze anodised aluminium (15µm) or paint at extra cost (page 7).

**RP58** Satin clear (silver) anodised aluminium (15µm) or paint at extra cost (page 7).

**Fixing:** Self adhesive or can be screw fixed. *Note: Contact surface must be clean, smooth and if painted, well cured. Self adhesive seals will not adhere to oiled or alkyd finishes or to easy clean wash and wear paint surfaces.*

**Seal:** Black fine, dense, UV stabilised nylon filaments.

**Sizes:** Available in stock lengths.

#### Approvals

**Energy** NCC Pt. 3.12.3.3 & J3.4.

**BAL ≤FZ** when used on a garage in accordance with AS 3959.

#### RP57

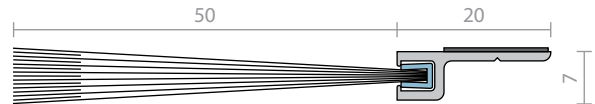

#### RP58

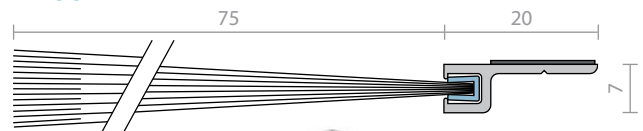

# Brush Strip Seals

## Nylon Filament



### RP74



A nylon brush strip seal with a self adhesive aluminium holder. Mounted to the inside or outside door head and bottom face, RP74 provides a very neat sealing solution with the advantage of final on site installation which overcomes unforeseen floor or sill variation.

Used in conjunction with Raven threshold plates.

**Location:** Frames or bottoms of single, double, sliding and double acting doors.

**Min/Max Gap:** Up to 13mm (user determined).

**Finish:** Satin clear (silver), bronze anodised aluminium (15µm) or paint at extra cost (page 7).

**Fixing:** Self adhesive or can be screw fixed. *Note: Contact surface must be clean, smooth and if painted, well cured. Self adhesive seals will not adhere to oiled or alkyd finishes or to easy clean wash and wear paint surfaces.*

**Seal:** Black fine, dense, UV stabilised nylon filaments.

**Sizes:** Available in stock lengths.

#### Approvals

**Fire**  
FRL & FRR-/120/30 and FD120.

**Energy** NCC Pt. 3.12.3.3 & J3.4.  
BAL ≤FZ when used on a garage door or on an approved side hung fire door in accordance with AS 3959.

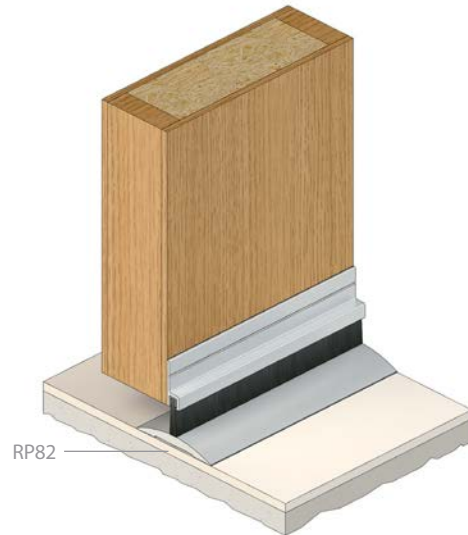
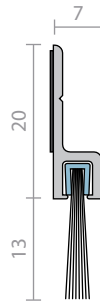

### RP74F



A nylon brush strip seal that is ideal for sliding or double acting doors. Can also be used for the stiles of tilt-up doors. The brush houses a unique medium temperature fin, which is effective in the sealing of medium temperature smoke, noise and weather.

Used in conjunction with Raven threshold plates..

**Location:** Frames or bottoms of single, double, sliding and double acting doors as well as stiles of tilt up doors.

**Min/Max Gap:** Up to 13mm (user determined).

**Finish:** Satin clear (silver), bronze anodised aluminium (15µm) or paint at extra cost (page 7).

**Fixing:** Self adhesive or can be screw fixed. *Note: Contact surface must be clean, smooth and if painted, well cured. Self adhesive seals will not adhere to oiled or alkyd finishes or to easy clean wash and wear paint surfaces.*

**Seal:** Black fine, dense, UV stabilised nylon filaments with a medium temperature smoke barrier fin.

**Sizes:** Available in stock lengths

#### Approvals

**Smoke** NCC Spec. C3.4 for smoke doors.

**Energy** NCC Pt. 3.12.3.3 & J3.4.  
BAL ≤FZ when used on a garage door or on an approved side hung fire door in accordance with AS 3959.

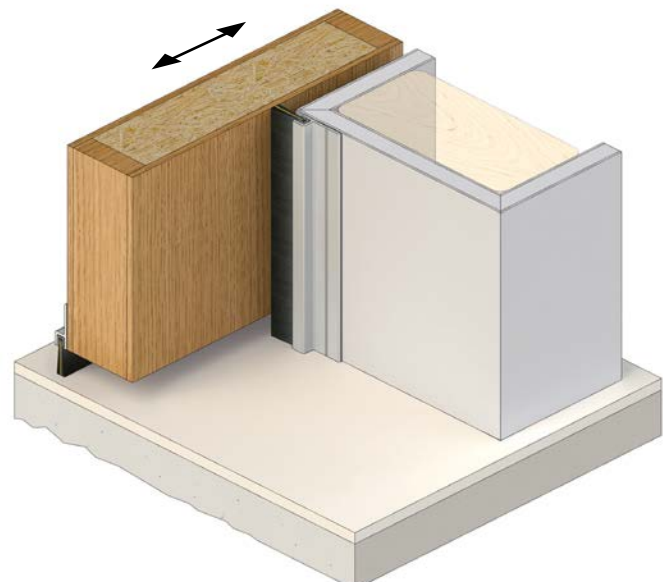
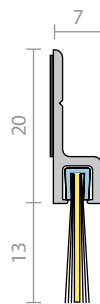

# Brush Strip Seals

## Nylon Filament

### RP75



A nylon brush strip seal that is ideal for sliding or double acting doors. Can also be used for the stiles of tilt-up doors.

Used in conjunction with Raven threshold plates.

**Location:** Frames or bottoms of single, double, sliding and double acting doors as well as stiles of tilt up doors.

**Min/Max Gap:** Up to 19mm (user determined).

**Finish:** Satin clear (silver), bronze anodised aluminium (15µm) or paint at extra cost (page 7).

**Fixing:** Self adhesive or can be screw fixed. *Note: Contact surface must be clean, smooth and if painted, well cured. Self adhesive seals will not adhere to oiled or alkyd finishes or to easy clean wash and wear paint surfaces.*

**Seal:** Black fine, dense, UV stabilised nylon filaments.

**Sizes:** Available in stock lengths.

#### Approvals

**Energy** NCC Pt. 3.12.3.3 & J3.4.

**BAL**  $\leq$ FZ when used on a garage in accordance with AS 3959.

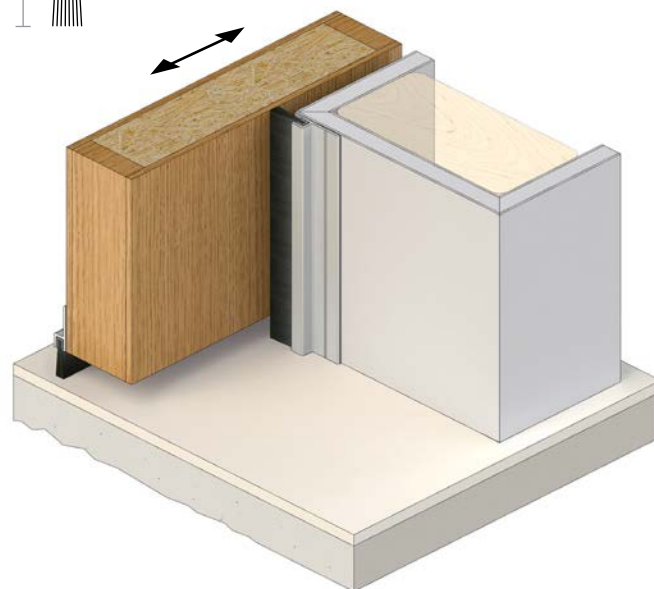
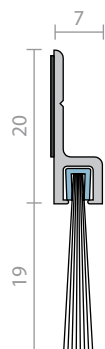

### RP129F



A heavy duty medium temperature smoke door bottom seal. The seal is achieved by a pair of nylon brush strips with a medium temperature smoke barrier.

The seal can be checked out or drilled to accommodate the pivot, thereby providing a continuous seal.

Can be used in conjunction with RP130Si, other Raven perimeter seals and threshold plates.

**Location:** Bottom of double butt hinged or centre pivot double acting doors.

**Min/Max Gap:** 15mm to 18mm.

**Finish:** Satin clear (silver) anodised aluminium (15µm) or paint at extra cost (page 7).

**Fixing:** Screw fix. Zinc plated, cross recess head S.T. screws supplied.

**Seal:** RP52F. Black fine and dense nylon filaments, UV stabilised medium temperature smoke barrier fin and galvanised steel spine.

**Sizes:** Available in stock lengths.

#### Approvals

**Smoke AUS/NZ:** NCC Spec. C3.4. NZ BC Compliance Doc. C/AS1 6.19.2(b). AS1530.7 & BS EN 1634-3 (similar to BS 476 section 31.1). Meets smoke leakage rates specified in AS6905 & EN 13501-2 "Sa", "Sm".

**Energy** NCC Pt. 3.12.3.3 & J3.4.

**Durability** Tested to over 1,000,000 operating cycles without failure.

**Patented, Registered Design.**

**BAL**  $\leq$ FZ when used on a garage in accordance with AS 3959.

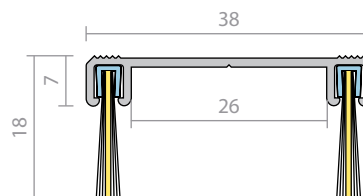

## Anti-finger Jam Seal

Finger-pinch protection devices should be installed wherever doors are accessible to children in schools, kindergartens and children day care centres. Finger-pinch injuries in doors are a significant cause of injury and claims against liability insurance in child care situations. RP62 helps prevent fingers being jammed on the hinge side of a door. It is recommended RP62 be installed to the full height of the door/jamb for maximum protection. This will reduce tampering and accidental deposit of toys or waste material behind the anti-finger jam seal. RP62 can be retrofitted to butt hinged or centre pivot doors and conform to the UK Workplace (Health, Safety and Welfare) Regulations 1992 Statutory Instrument 1992 No. 3004 clause 18. The RP62BW is reversible for either a brown or white finish.

### RP62



A safety strip which prevents fingers being jammed on the hinge side of a door. It is fixed to the door and the jamb on the hinged side.

*Note: It is recommended to fit RP62 to the full height of the door/jamb for maximum protection. For longer lengths, butt join together.*

**Location:** Door and jamb of butt hinged or centre pivot doors.

**Finish:** Satin clear (silver) anodised aluminium (15µm).

**Fixing:** Screw fix. Zinc plated, cross recess head S.T. screws and cover strip supplied. Fixing holes are pre-slotted.

**Seal:** RP362. Black EPDM rubber.

**Sizes:** 2100mm.

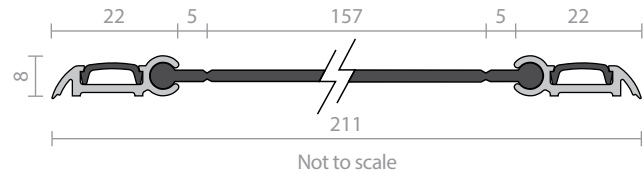

### RP62BW



A safety strip which prevents fingers being jammed on the hinge side of a door. It is fixed to the door and the jamb on the hinged side.

*Note: It is recommended to fit RP62BW to the full height of the door/jamb for maximum protection. For longer lengths, butt join together.*

RP62BW is reversible for a brown or white finish.

**Location:** Door and jamb of butt hinged or centre pivot doors.

**Finish:** Satin clear (silver) anodised aluminium (15µm).

**Fixing:** Screw fix. Zinc plated, cross recess head S.T. screws and cover strip supplied. Fixing holes are pre-slotted.

**Seal:** RP462BW. Reversible flexible brown/white PVC rubber. Brown and white flexible PVC cover strips included.

**Sizes:** 2500mm, 2100mm.

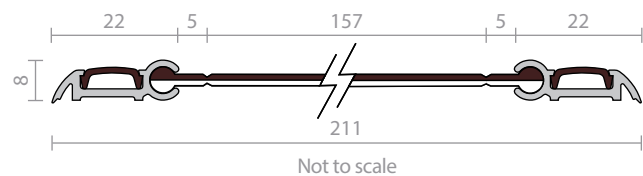

## RP62LGBK



A safety strip which prevents fingers being jammed on the hinge side of a door. It is fixed to the door and the jamb on the hinged side.

*Note: It is recommended to fit RP62LGBK to the full height of the door/jamb for maximum protection. For longer lengths, butt join together.*

RP62LGBK is reversible for a light grey or black finish.

**Location:** Door and jamb of butt hinged or centre pivot doors.

**Finish:** Satin clear (silver) anodised aluminium (15µm).

**Fixing:** Screw fix. Zinc plated, cross recess head S.T. screws and cover strip supplied. Fixing holes are pre-slotted.

**Seal:** RP462LGBK. Reversible flexible light grey/black PVC rubber. Light grey and black flexible PVC cover strips included.

**Sizes:** 2500mm.

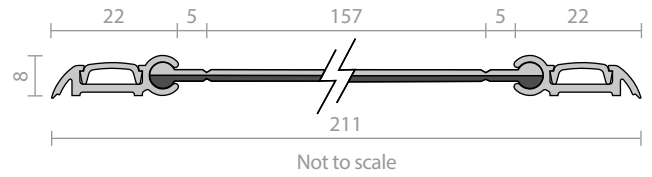

## Drip-strip

### RP67



A drip strip designed to shed or channel water away from the head of exposed doors. Particularly suitable for outward opening doors. The RP67 requires an allowance of 50mm overlap each side of the door opening.

**Location:** Above doors.

**Finish:** Satin clear (silver) anodised aluminium (15µm).

**Fixing:** Screw fix. Zinc plated, cross recess head S.T. screws supplied.

**Sizes:** Available in stock lengths.

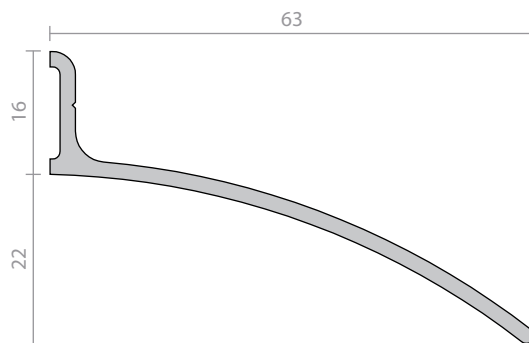

## Threshold Access Ramps

Raven Threshold Access Ramps are ideal for users of wheel chairs, walking frames, electric scooters and hand trolleys; anyone that regularly traverses tripping hazards at doorways or abrupt surface transitions around the home or in the work place.

Made from slip resistant recycled rubber, Raven Threshold Access Ramps will be welcomed by home owners, building occupiers, facility managers and OH&S personnel who recognise the need for a permanent and inexpensive retrofit solution to assist access and mobility in the home, at work or in the commercial environment. Until now, the problem involved a trade's person, the use of messy cement, fabricated metal plate or plywood to make and install a threshold access ramp. The new DIY alternative is the Raven Threshold Access Ramp. Simply lay the ramp in place or permanently fix with builders adhesive. Raven Threshold Access Ramps are extremely durable, will last for years and require no maintenance.

Available in two convenient ramp heights: 25mm (model TR025) and 50mm (model TR050) - gradient 1:8 (front).

The TR025 & TR050 are retrofit threshold access ramps, designed to help upgrade non-compliant doorways to meet Australian standard AS1428.1, 10.5. When a doorway has a rise height above 35mm maximum, the TR050 becomes a user determined solution. A deemed to satisfy compliance if required should be sort from a building engineer or access consultant.

### TR025

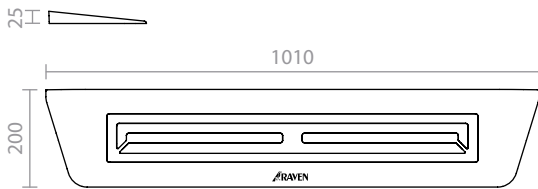

### TR050

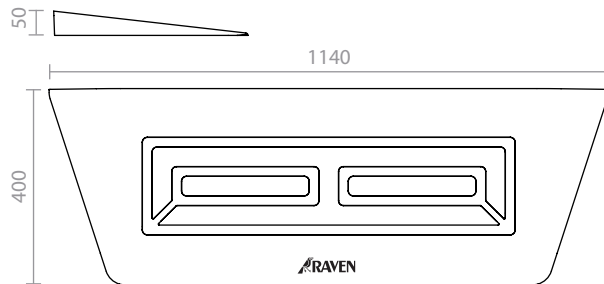





Some of the many extrusions that are used in the seals within this catalogue, may be ordered separately.

**RP303** solid EPDM

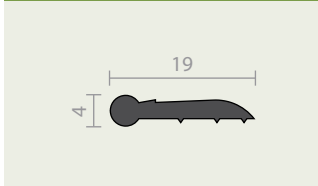

**RP308Si** silicon rubber (SE)

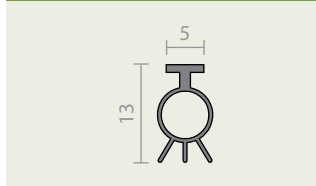

**RP310Si BK** silicon rubber (SE)

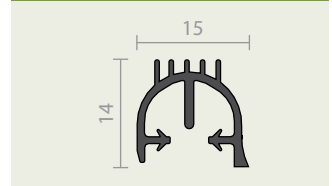

**RP310Si LG** silicon rubber (SE)

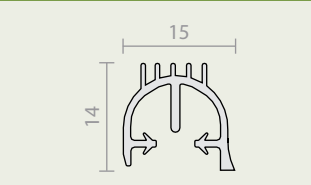

**RP316Si BK** silicon rubber (SE)

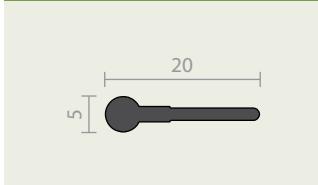

**RP316Si GR** silicon rubber (SE)

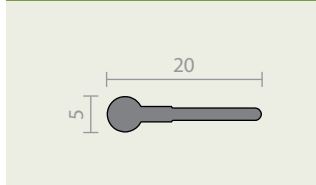

**RP320** silicon rubber (SE)



**RP323** solid EPDM (SE)

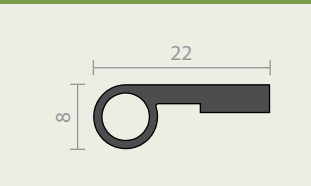

**RP326** solid EPDM

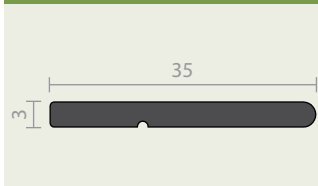

**RP330** solid EPDM

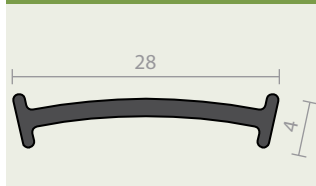

**RP331** solid EPDM

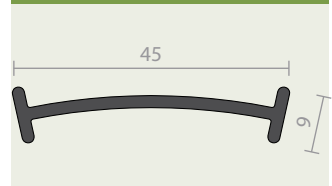

**RP338** sponge EPDM (SE)

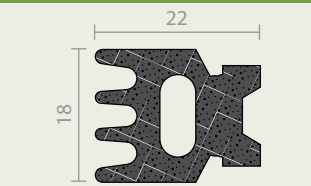

**RP338Si BK** silicon rubber (SE)

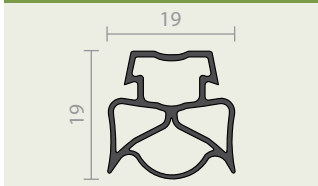

**RP338Si GR** silicon rubber (SE)

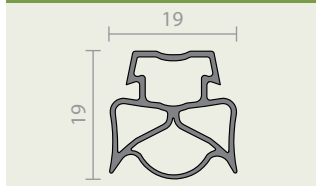

**RP343Si** NEW silicon rubber (SE)

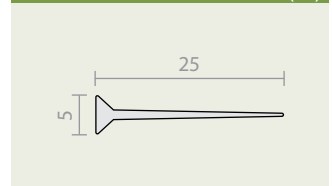

**RP347Si** silicon rubber (SE)

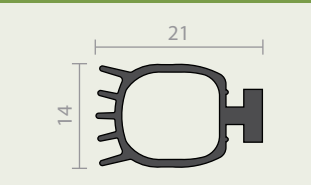

**RP351Si** silicon rubber (SE)

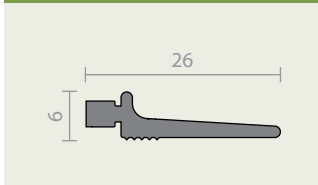

**RP354** solid EPDM (SE)

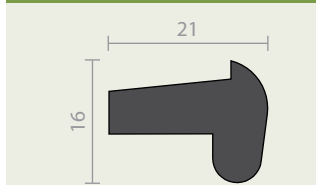

**RP362 (Black)** solid EPDM

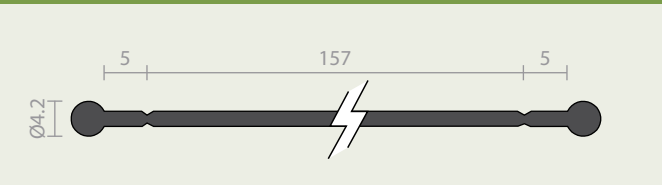

**RP371Si BK** silicon rubber (SE)

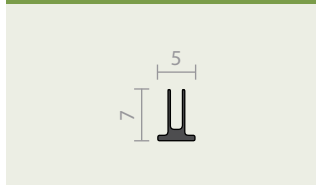

**RP371Si GR** silicon rubber (SE)

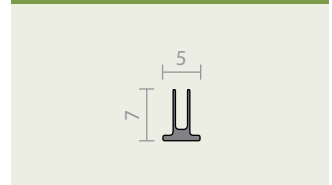

**RP378Si** silicon rubber (SE)

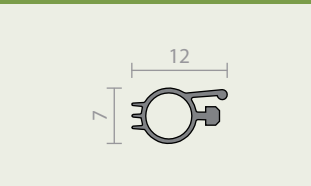

**RP384Si** silicon rubber (SE)

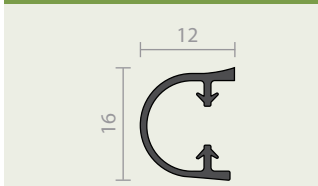

**RP381** solid EPDM

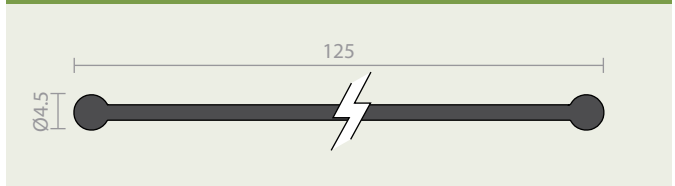

**RP393Si** silicon rubber (SE)

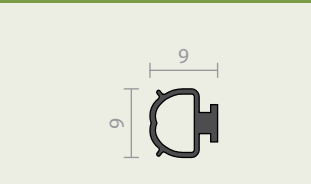

**RP394Si BK** silicon rubber (SE)

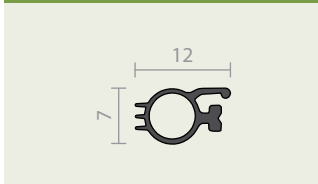

<b>RP394Si GR</b> silicon rubber (SE) 	<b>RP394Si LG</b> silicon rubber (SE) 	<b>RP394HSi GR</b> silicon rubber (SE) 	<b>RP394HSi LG</b> silicon rubber (SE) 
<b>RP3126Si</b> silicon rubber (SE) 	<b>RP3129Si</b> silicon rubber (SE) 	<b>RP404</b> flexible PVC 	<b>RP404a</b> flexible PVC 
<b>RP404b</b> flexible PVC 	<b>RP410</b> flexible PVC 	<b>RP410a BK</b> rigid PVC 	<b>RP410a LG</b> rigid PVC 
<b>RP423 BK</b> flexible PVC 	<b>RP423 BR</b> flexible PVC 	<b>RP423 GR</b> flexible PVC 	<b>RP423 LG</b> flexible PVC 
<b>RP424</b> rigid PVC 	<b>RP435 BR</b> rigid PVC 	<b>RP435 LG</b> rigid PVC 	<b>RP460</b> flexible TPE 
<b>RP462 BR</b> flexible PVC 	<b>RP462 WH</b> flexible PVC 	<b>RP462 BW (Brown / White)</b> flexible PVC 	
<b>RP462 LGBK (Light Grey / Black)</b> <span style="color: red; font-weight: bold;">NEW</span> flexible PVC 	<b>RP469</b> rigid/flexible PVC 	<b>RP486</b> rigid/flexible PVC 	
<b>RP487</b> rigid PVC 			

Raven Seals are designed to meet the most rigorous International Standards and Building Codes. Throughout, icons have been used to readily identify and make product selection easier. Raven Seals, in the main, have been tested to Australian, New Zealand, British, ISO and EN standards. In many cases they are the same or similar to US standards and Chinese building code requirements. Specifiers should determine the suitability of products shown or contact Raven's Technical Department for assistance.



AUS/NZ



UK/EU

### Noise - Acoustic



#### NCC

**Sound Transmission & Insulation;** Sect. F Parts F5.0, F5.5 (b),  
**Health & Amenity;** Sect. 2 Part 2.4, O2.4.6,  
**Sound Insulation;** F2.4.6, P2.4.6 V2.4.6, Sect. 3.8, 3.8.6 (appropriate performance requirements (a) (b)).

**AS 1191 (ISO 140.3)** Measurements of airborne sound transmission loss etc.,  
**AS 1276** Rating of sound insulation in buildings etc. (ISO 717.1),  
**AS 2253** Field measurement of the reduction in airborne sound transmission in buildings.

**ISO 717.1** Rating of sound insulation in buildings.

**NZ BC Compliance Doc. G** (airborne and impact sound).

**ASTM E 336, ASTM E 413.**

#### Building Regulations **Approved Document E,**

**Building Bulletin 93** - Special Acoustic Conditions for Schools,  
**BS EN ISO 140.3** Acoustics - Measurement of sound insulation in buildings and of building elements (previous BS 2750),  
**BS 5821** Rating the sound insulation in buildings and building elements (same as **ISO 717.1**),  
**BS EN 10140** Series Standards - Laboratory measurement of sound insulation.

### Fire and Smoke



#### NCC

**Fire Resistance;** Sect. C Parts C3, C3.0 - C3.11, Spec. C2.5, Spec. C3.4, Spec. D1.12 (d) (f), Sect. D Part D2.6.,

**Smoke Hazard Management;** Sect. Part E.

**Bushfire Areas;** Sect. G. Part G5.

**Fire Safety;** Part 2.3, **Bushfire Areas;** Part 2.3 F2.3.4, P2.3.4, SA 3.7.4.3 (c), Table SA 3.7.4.1 (external doors).

**AS 3959** Construction of building in bushfire-prone areas,  
**AS 1530.4** Fire resistance tests of elements of building construction,  
**AS NZS 1905.1** Components for the protection of openings in fire resistant walls,  
**AS 1851-6** and **AS 1851** Section 17 & 18 Maintenance of fire protection equipment,  
**AS 1530.7** Smoke control door and shutter assemblies,  
**AS 1735.11** Lifts, escalators and moving walks - Fire rated landing doors,  
**AS 6905** Smoke Doors.

**NZ BC Compliance Doc. C** (Fire Safety),

**NZS 4520** Fire Doors.

#### Building Regulations **Approved Document B,**

**ISO 834** Fire resistance test - Elements of building construction,  
**ISO 3008** Fire resistance test - Door and shutter assembly,  
**BS EN 1634-1** Fire resistance tests for doors and shutter assemblies,  
**BS EN 1634-3** Smoke control test for door and shutter assemblies,  
**BS 5588** Fire precautions in the design, construction & use of building,  
**BS 476** Part 20 Method for determination of the fire resistance of elements of construction,  
**BS 476** Section 31.1 Method for measuring smoke penetration through door sets & shutter assemblies,  
**BS 8214** Code of practice for fire door assemblies with non-metallic leaves,  
**ISO 5925-1** Ambient and medium temperature leakage test,  
**ISO DIS 12472** Fire test - Determination of the efficiency of the intumescent seals with respect to the fire resistance of timber door assemblies,  
**BS EN 13501-2** Fire classification of construction products and building elements. Classification using data from fire resistance tests, excluding ventilation services.

### Weather and Energy



#### NCC

**Health & Amenity;** Sect. F.,

**Energy Efficiency Installations;** Part I2,

**Energy Efficiency - Building Sealing;** Sect. J. JP1(f), Part J3. J3.4, Part 3.12.3.3,

**Bushfire Areas;** Sect. G. Part G5,

**Fire Safety;** Part 2.3, **Bushfire Areas;** Part 2.3 F2.3.4, P2.3.4, SA 3.7.4.3 (c), Table SA 3.7.4.1 (external doors),

**Energy Efficiency;** Sect. 2., Part 2.6 O2.6 F2.6 P2.6.1(f),

**Building Sealing;** Part 3.12. contents 3.12.3.3.

**AS 4420.4** Air infiltration test,  
**AS 4420.5** Water penetration test,  
**AS 2047** Windows & doors in buildings,  
**AS 1530.7** Smoke control door and shutter assemblies,  
**AS 3959** Construction of building in bushfire-prone areas.

**NZ BC Compliance Doc. H** (energy efficiency) air tightness H1.3.1, H1.3.3.

#### Building Regulations **Approved Document L1 & L2,**

**BS 7386, BS 8104, CIBSE TM 23** Testing of building for leakage (Part L1 & L2 requirements),  
**BS 5368** Methods of testing windows (various parts - air permeability, watertightness, wind resistance),  
**BS EN 1634-3** Smoke control test for door and shutter assemblies,  
**BS EN 10077-1** Thermal performance of windows, doors, shutters,  
**IEC 529** Degrees of protection provided by enclosures for electrical equipment,  
**ISO 8272** Air permeability test,  
**ISO 9972** Thermal insulation - Determination of building air tightness - Fan pressurisation method,  
**ISO 5925-1** Evaluation of performance of smoke control door assemblies (Part 1 Ambient temperature test).

### Access and Mobility



#### NCC

Sect. D Part D2, D2.15 and D3, D3.3

**Housing Provisions** Performance Provisions; Sect. 2. Part 2.5 (thresholds at door ways).

**AS 1428** Design for access & mobility.

**AS 4299** Adaptable Housing

**NZ BC Compliance Doc. D** (Access routes),

**NSZ 4121** Design for access & mobility.

#### Building Regulations **Approved Document M,**

'Access and Facilities for Disabled People' and 'Accessible Thresholds in New Housing: Guidelines for House Builders and Designers'.

**BS 8300** Design of buildings and their approaches to meet the needs of disabled people. Code of Practice.



USA



CHINA

## Noise - Acoustic



IBC International Building Code,  
**ASTM E 90** Standard method for laboratory measurement of airborne sound transmission loss of door panels and door systems,  
**ASTM E 413** Classification for rating sound insulation,  
**ASTM E 336** Standard test for measurement of airborne sound insulation in buildings,  
**ASTM E 1408-91** Standard Test Method for Laboratory Measurement of the Sound Transmission Loss of Door Panels and Door Systems.

**GBJ 118 - 88** 《民用建築隔音設計規範》  
**GBJ 87 - 85** 《工業企業噪音控制設計規範》  
**GB 8485** 《建築外窗空氣隔聲性能分級及其檢測方法》  
**JGJ 57 - 2000** 《劇場建築設計規範》  
**JGJ 58 - 88** 《電影院建築設計規範》  
**JGJ 67 - 89** 《辦公建築設計規範》  
**JGJ 62 - 90** 《旅館建築設計規範》  
**GB 50096 - 99** 《住宅 設計規範》  
**GB 50073 - 2001** 《潔淨廠房設計規範》

## Fire and Smoke



IBC International Building Code,  
**NFPA 101** Life safety Code,  
**NFPA 105** Recommended practice for the installation of smoke and draft control door assemblies,  
**ASTM E 2074** Standard Test Method for Fire Tests of Door Assemblies, Including Positive Pressure Testing of Side Hinged and Pivoted Swinging Door Assemblies,  
**UL 10B** Fire tests of door assemblies,  
**UL 10C** Fire tests of door assemblies under positive pressure,  
**UBC** Fire tests,  
**UBC 7.210** Smoke and draft control door assemblies,  
**UL 1784** Standard for safety for air leakage tests for door assemblies,  
**ASTM E 152** Methods of fire test of door assemblies,  
**NFPA 252** Standard method of fire tests of door assemblies,  
**NFPA 80** Installation standard for fire doors & windows,  
 Compatibility of related standards with minor wording differences,  
**ASTM E 136 = UBC 43-1, ASTM E 84 = UL 723 = UBC 42-1 = NFPA 255, ASTM E 110 = UL 263 = UBC 43-1 = NFPA 251.**  
**ANSI/BHMA A156.22** American National standard for door gasketing and edge seal systems.

**GBJ 16 - 87** 《建築設計防火規範》  
**JGJ 49 - 88** 《綜合醫院建築設計防火規範》  
**GB 50045 - 95** 《高層民用建築設計防火規範》  
**JGJ 39 - 87** 《托兒所, 幼兒園建築設計規範》  
**GB 50226 - 95** 《鐵路旅客車站建築設計規範》  
**JGJ 60 - 99** 《汽車客運站建築設計規範》  
**JGJ 86 - 92** 《港口客運站建築設計規範》  
**GBJ 39 - 90** 《村鎮建築設計防火規範》  
**JGJ 38 - 99** 《圖書館建築設計規範》  
**JGJ 25 - 2000** 《檔案館建築設計規範》  
**JGJ 66 - 91** 《博物館設計規範》  
**JGJ 57 - 2000** 《劇場建築設計規範》  
**JGJ 58 - 88** 《電影院建築設計規範》  
**JGJ 62 - 90** 《旅館建築設計規範》  
**JGJ 41 - 81** 《文化館建築設計規範》  
**GB 50073 - 2001** 《潔淨廠房設計規範》

## Weather and Energy



IBC International Building Code,  
**ANSI/ASHRAE/IESNA** Standard 90 P Energy conservation in new building design Section 4,  
**ASTM E283** Rate of air leakage through exterior windows, curtain walls and doors,  
**NFRC 400** Procedure for Determining Fenestration Product Air Leakage.

**JGJ 37 - 87** 《民用建築設計通則》  
**GBJ 301 - 88** 《關於鋁合金門窗安裝工程檢驗評定標準》  
 《鋼結構施工質量驗收規範》  
**JGJ 102 - 96** 《玻璃幕牆工程技術規範》  
**GB 7106** 《建築外窗抗風壓分級及檢測方法》  
**GB 7108** 《建築外窗雨水滲透性能分級及檢測方法》  
**GB 50096 - 99** 《住宅 設計規範》  
**JGJ 26 - 95** 《民用建築節能設計標準》  
**GB 50176 - 93** 《民用建築熱工設計規範》  
**JGJ 38 - 99** 《圖書館建築設計規範》  
**JGJ 25 - 2000** 《檔案館建築設計規範》  
**JGJ 66 - 91** 《博物館設計規範》  
**JGJ 41 - 81** 《文化館建築設計規範》  
**GB 50073 - 2001** 《潔淨廠房設計規範》  
**GB 50176 - 93** 《民用建築熱工設計規範》

## Access and Mobility



IBC International Building Code, Residential Code & ADAAG,  
**ANSI 117** Building access for people with disability,  
**ANSI/BHMA A156.21** American National standard for Thresholds.

**88**建標字第204號《方便殘疾人使用的城市道路和建築物設計規範》

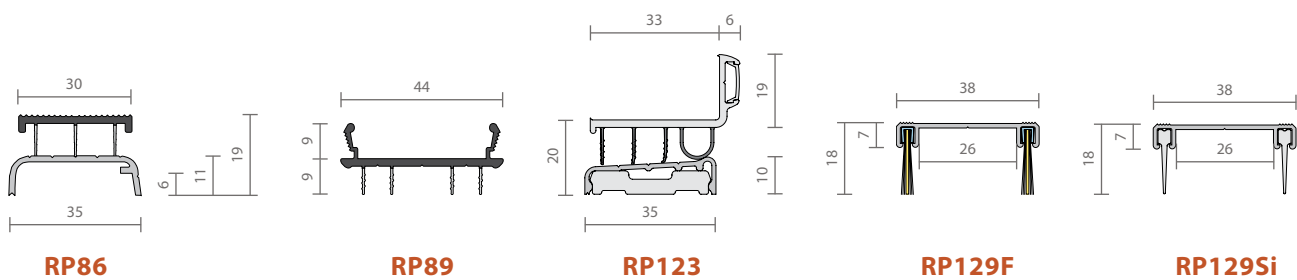
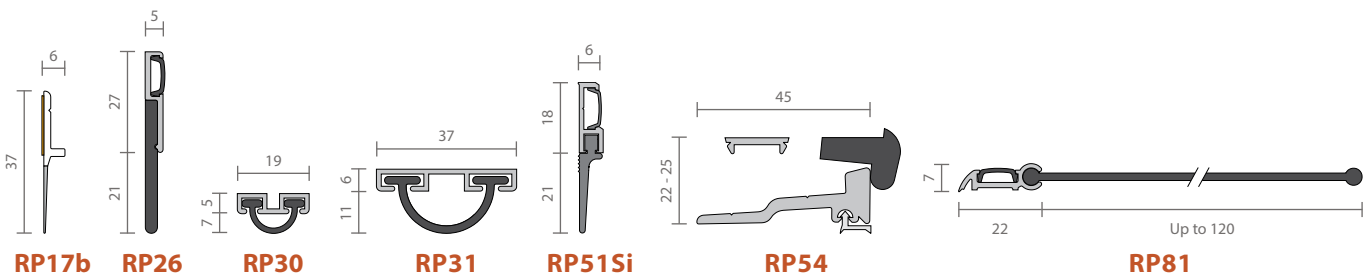
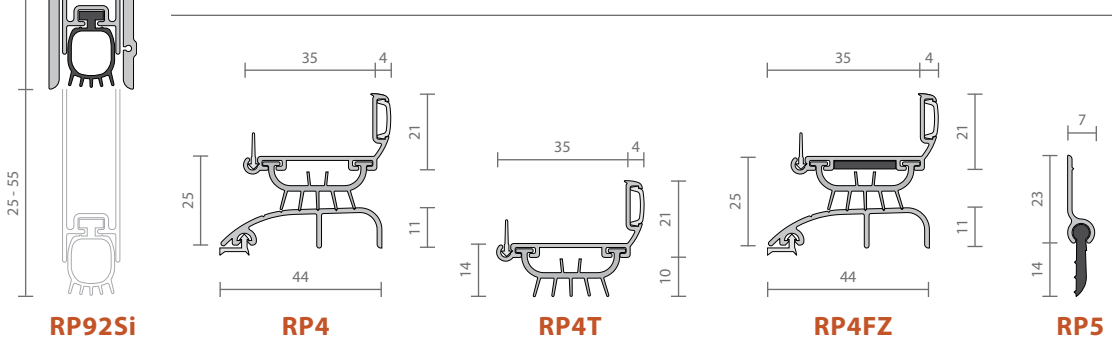
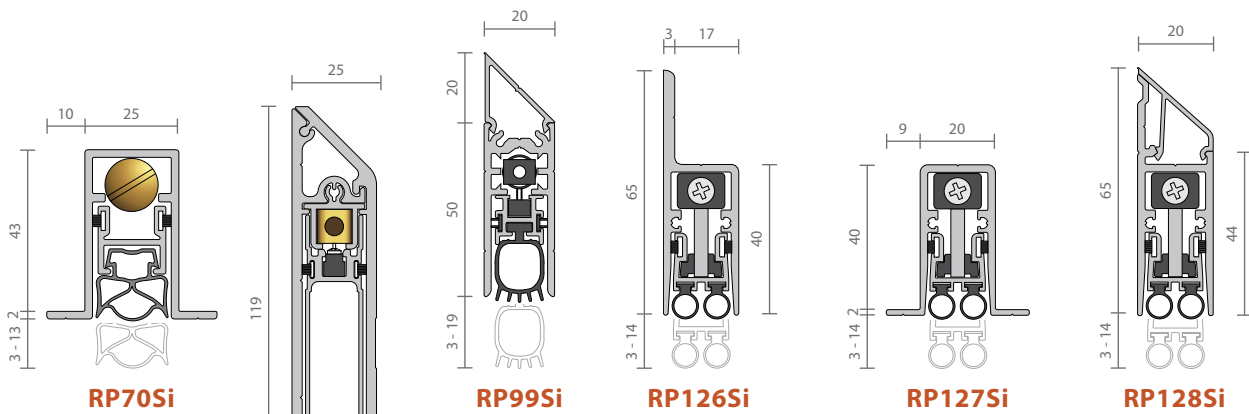
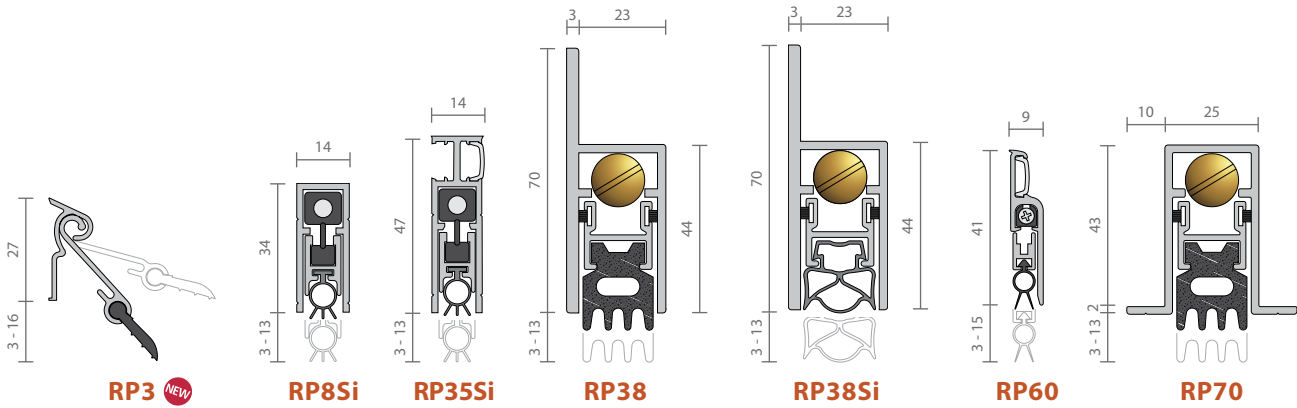

## Threshold Plate Seals

p.58

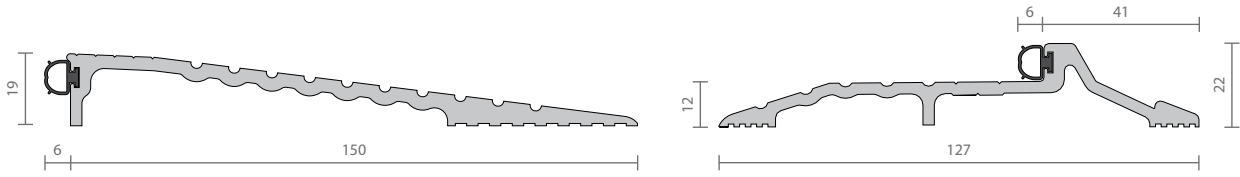

**RP97Si**

**RP109Si**

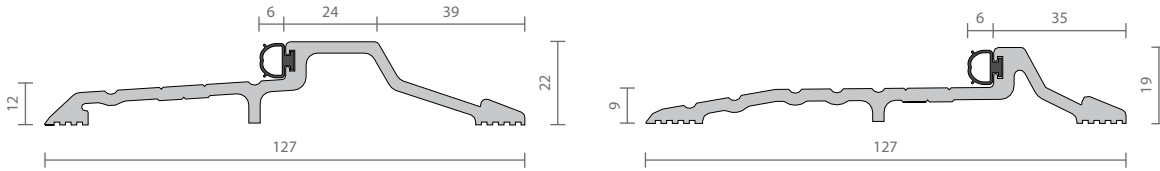

**RP110Si**

**RP111Si**

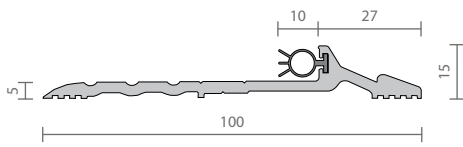

**RP117Si**

## Threshold Plates

p.62

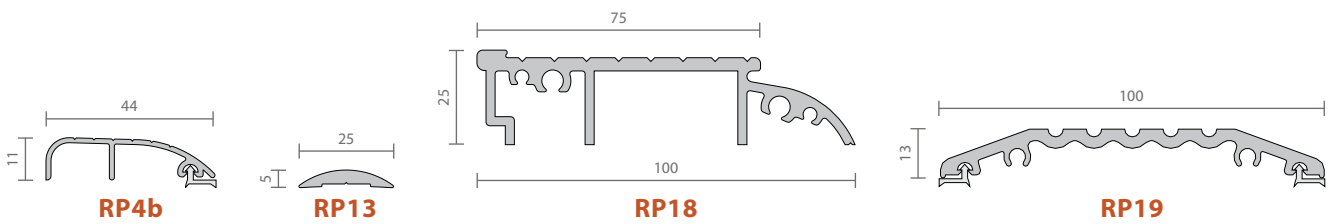

**RP4b**

**RP13**

**RP18**

**RP19**

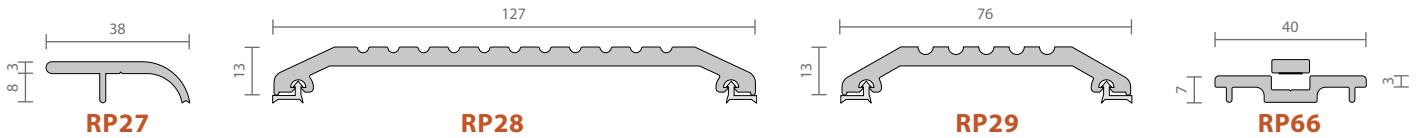

**RP27**

**RP28**

**RP29**

**RP66**

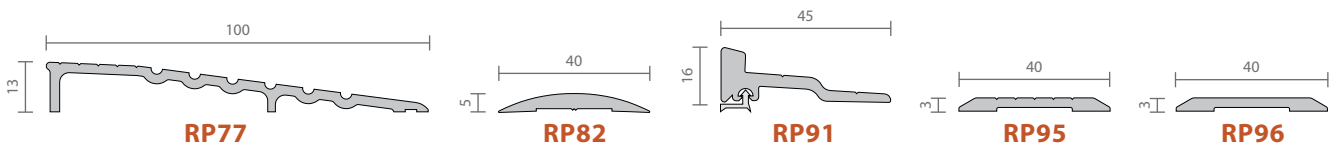

**RP77**

**RP82**

**RP91**

**RP95**

**RP96**

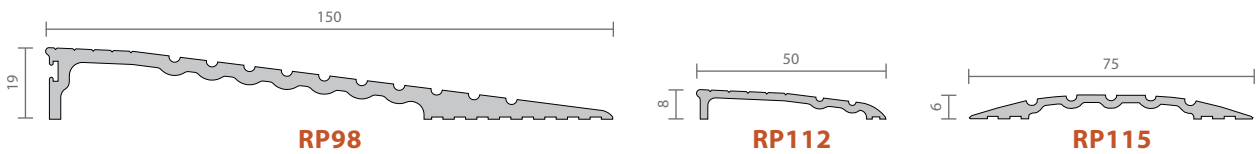

**RP98**

**RP112**

**RP115**

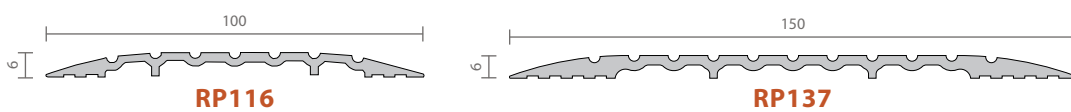

**RP116**

**RP137**

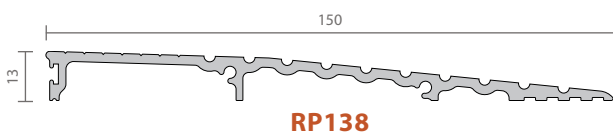

**RP138**

## Door Frame / Perimeter Seals

p.70

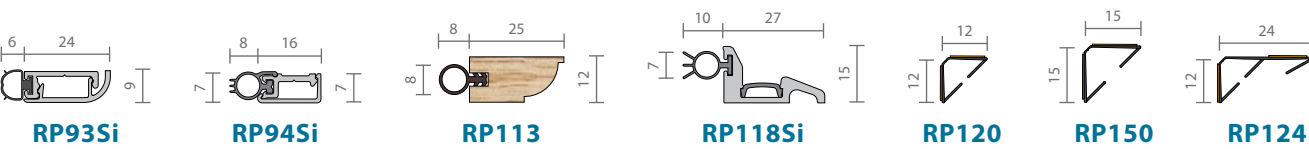
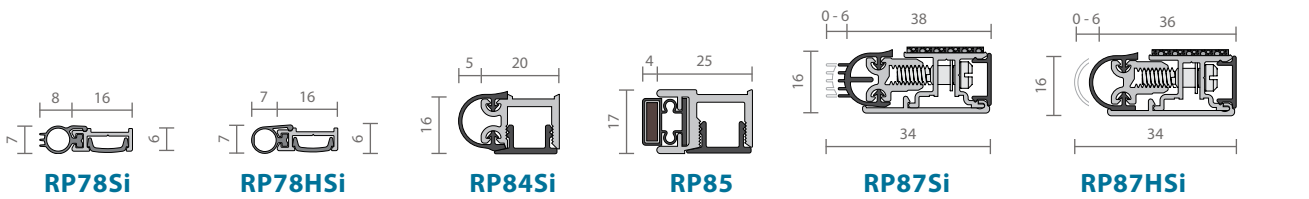
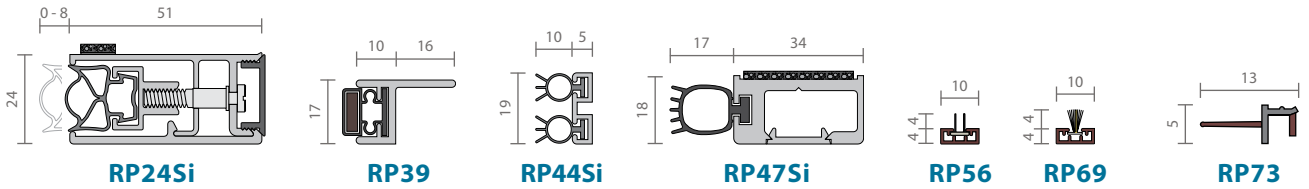
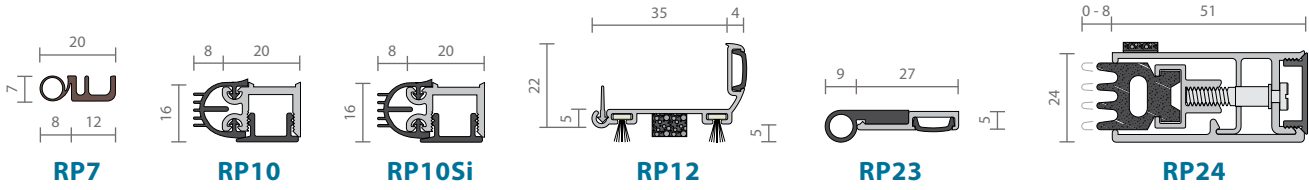

## Astragals (Meeting Stiles Seals)

p.85 - p.90

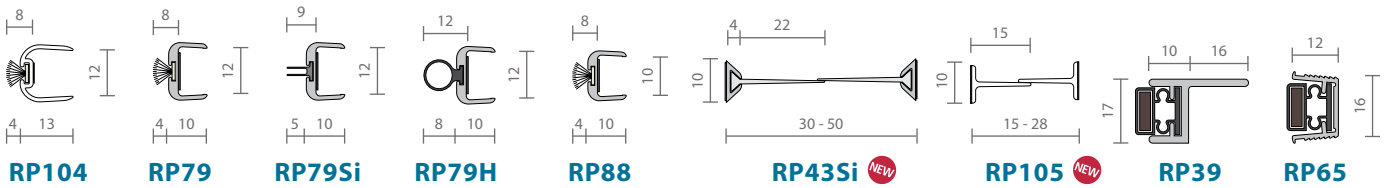
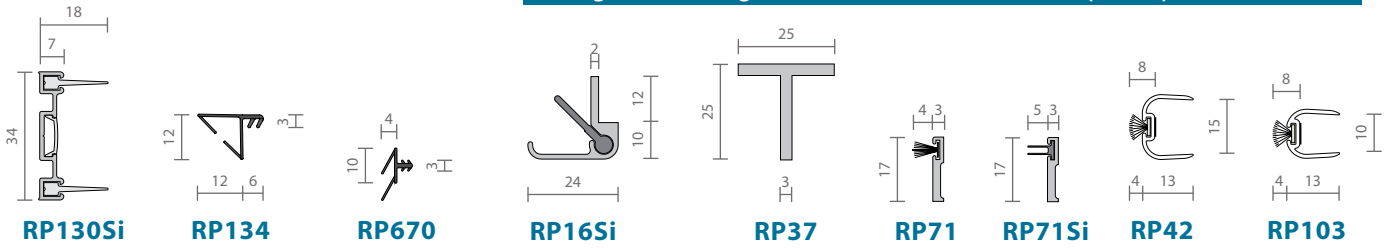

## Weather Stripping - Silicon RP500 Series and TPE RP600 Series

p.91 - 93

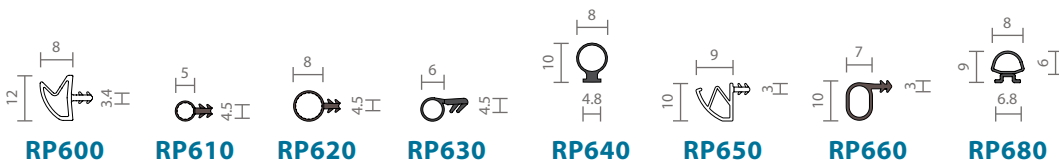



## Self-adhesive Seals

p.94

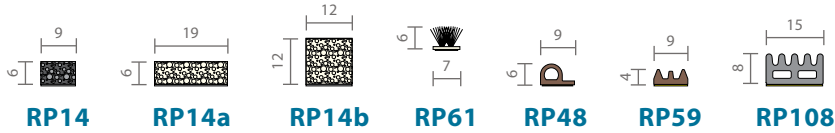

## Intumescent Fire Seals

p.95

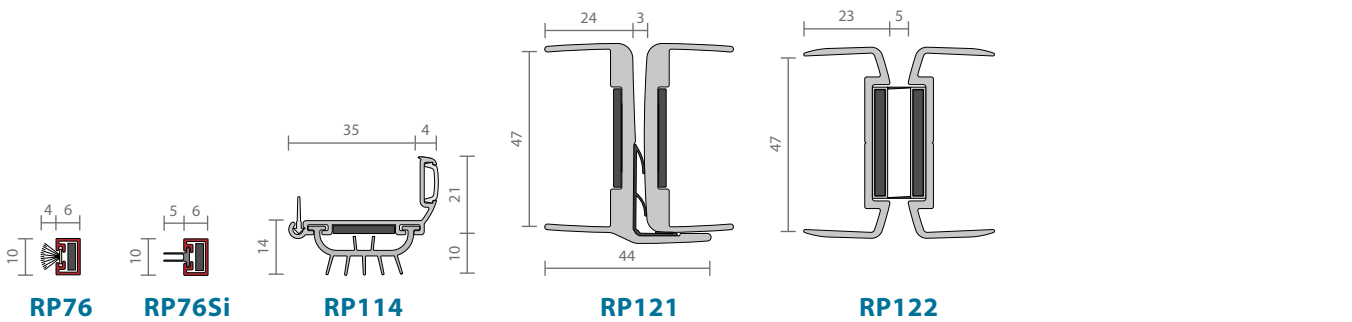
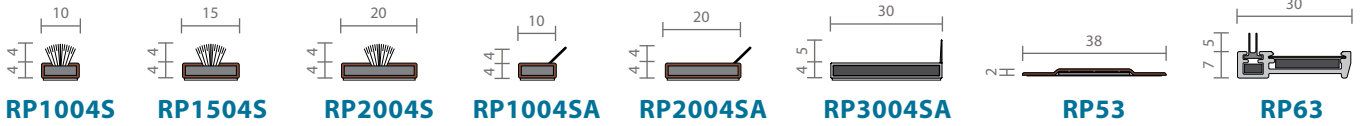
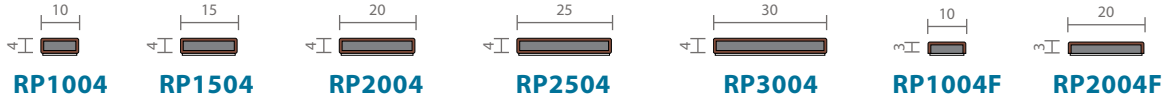

## Brush Strip Seals

p.101

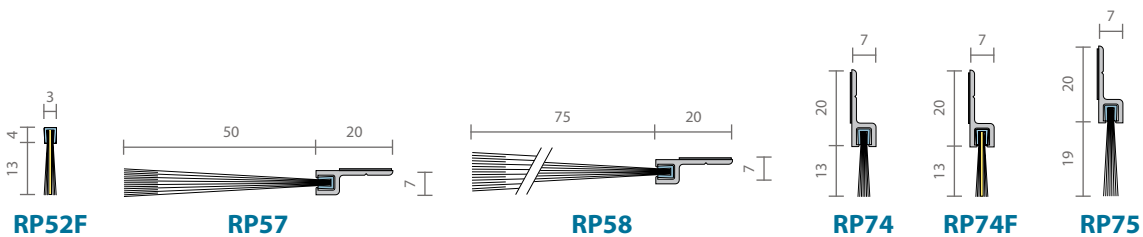
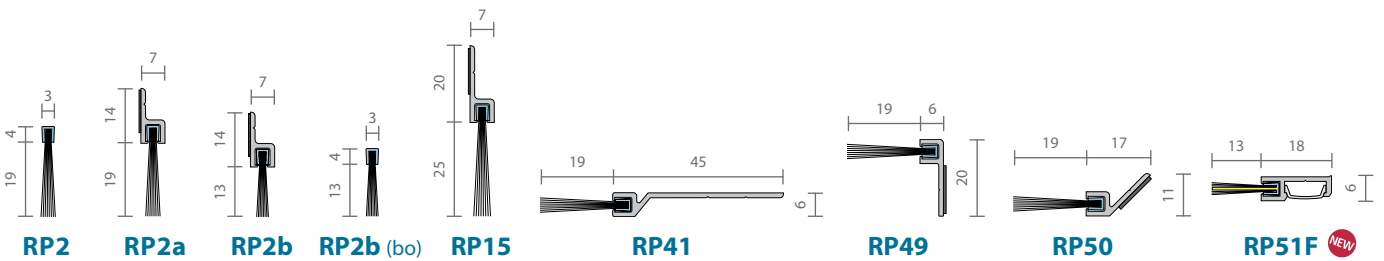

## Complementary Products

p.108

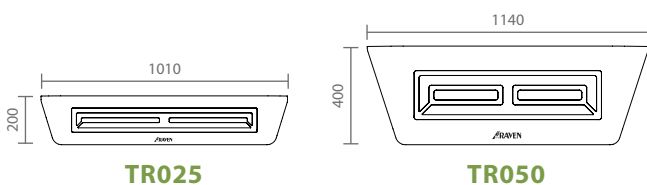
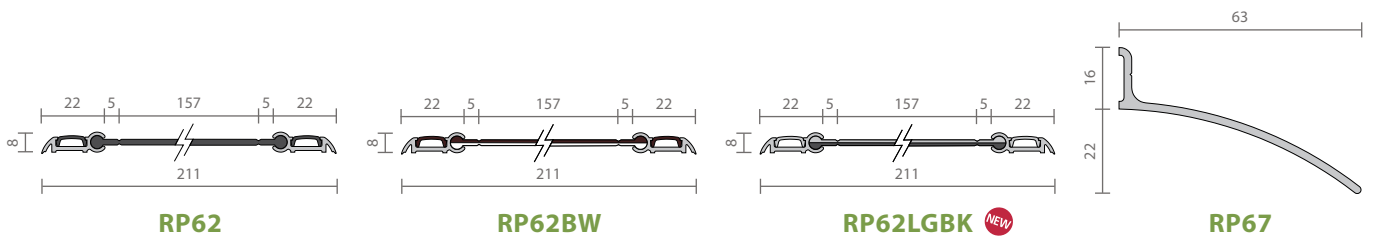

## Product Index



Product	Page	Product	Page	Product	Page	Product	Page
RP2	57, 101	RP57	12, 29, 57, 105	RP112	68	RP404b	113
RP2a	12, 29, 57, 102	RP58	29, 57, 105	RP113	10, 81	RP410	113
RP2b	29, 57, 102	RP59	94	RP114	28, 51, 98	RP410a BK	113
RP2b (brush only)	57, 90, 101	RP60	45	RP115	11, 25, 68	RP410a LG	113
RP3	43	RP61	94	RP116	11, 68	RP423 BK	113
RP4	10, 50	RP62	108	RP117Si	39, 61	RP423 BR	113
RP4b	63	RP62BW	108	RP118Si	38, 39, 82	RP423 GR	113
RP4FZ	10, 28, 50	RP62LGBK	109	RP120	22, 23, 24, 27, 34, 40, 82, 90	RP423 LG	113
RP4T	12, 29, 51, 90	RP63	97	RP121	90, 99	RP424	113
RP5	51	RP65	89	RP122	90, 99	RP435 BR	113
RP7	71	RP66	66	RP123	10, 56	RP435 LG	113
RP8Si	10, 15, 21, 22, 23, 24, 25, 26, 27, 32, 33, 34, 35, 39, 40, 43	RP67	109	RP124	15, 22, 23, 24, 25, 27, 83, 90	RP460	113
RP10	10, 32, 35, 71	RP69	76	RP126Si	15, 22, 25, 27, 36, 48	RP462 BR	113
RP10Si	21, 26, 32, 35, 72	RP70	33, 40, 46	RP127Si	15, 22, 27, 36, 48	RP462 BW	113
RP12	72	RP70Si	46	RP128Si	15, 22, 27, 35, 36, 49	RP462 LGBK	113
RP13	63	RP71	35, 40, 86	RP129F	16, 23, 25, 56, 107	RP462 WH	113
RP14	94	RP71Si	15, 16, 23, 35, 36, 38, 39, 86	RP129Si	11, 16, 25, 57	RP469	113
RP14a	94	RP73	12, 13, 77, 90	RP130Si	11, 16, 23, 25, 83, 90	RP486	113
RP14b	94	RP74	29, 57, 106	RP134	84, 90	RP487	113
RP15	57, 103	RP74F	11, 12, 29, 57, 106	RP137	69	RP500	13, 91
RP16Si	10, 23, 25, 28, 35, 36, 39, 40, 85	RP75	28, 29, 57, 107	RP138	69	RP510	10, 13, 91
RP17b	12, 52	RP76	98	RP150	22, 23, 25, 27, 34, 82, 90	RP520	10, 13, 91
RP18	64	RP76Si	24, 98	RP303	112	RP530	13, 40, 91
RP19	11, 64	RP77	10, 66	RP308Si	112	RP540	13, 91
RP23	21, 73	RP78HSi	15, 78	RP310Si BK	112	RP550	13, 91
RP24	33, 36, 73	RP78Si	10, 21, 22, 23, 25, 26, 27, 28, 33, 40, 77	RP310Si LG	112	RP560	13, 91
RP24Si	15, 22, 26, 36, 74	RP79	87	RP316Si BK	112	RP600	13, 28, 92
RP26	52, 90	RP79H	87	RP316Si GR	112	RP610	13, 92
RP27	65	RP79Si	87	RP320	112	RP620	13, 92
RP28	65	RP81	54	RP323	112	RP630	13, 92
RP29	65	RP82	11, 28, 63	RP326	112	RP640	13, 92
RP30	53	RP84Si	10, 15, 33, 36, 78	RP330	112	RP650	13, 92
RP31	53	RP85	35, 79, 90	RP331	112	RP660	13, 92
RP35Si	21, 23, 24, 26, 44	RP86	55	RP338	112	RP670	24, 84
RP37	85	RP87HSi	15, 36, 80	RP338Si BK	112	RP680	93
RP38	33, 36, 40, 44	RP87Si	22, 27, 79	RP338Si GR	112	RP1004	96
RP38Si	15, 21, 22, 23, 25, 26, 27, 36, 45	RP88	87	RP343Si	112	RP1004F	96
RP39	74, 89	RP89	10, 11, 55	RP347Si	112	RP1004S	96
RP41	12, 28, 29, 57, 103	RP91	12, 28, 29, 67	RP351Si	112	RP1004SA	96
RP42	87	RP92Si	47	RP354	112	RP1504	96
RP43Si	88	RP93Si	27, 34, 38, 80	RP362	112	RP1504S	96
RP44Si	75	RP94Si	27, 34, 35, 81	RP371Si BK	112	RP2004	96
RP47Si	33, 38, 75	RP95	67	RP371Si GR	112	RP2004F	40, 96
RP48	94	RP96	16, 67	RP378Si	112	RP2004S	96
RP49	29, 57, 104	RP97Si	38, 59	RP381	112	RP2004SA	96
RP50	29, 57, 104	RP98	10, 66	RP384Si	112	RP2504	96
RP51F	29	RP99Si	27, 32, 34, 35, 47	RP393Si	40, 112	RP3004	96
RP51F	57, 104	RP103	87	RP394HSi GR	113	RP3004SA	96
RP51Si	28, 29, 53, 90	RP104	87	RP394HSi LG	113	RP3126Si	113
RP52F	11, 12, 16, 57, 105	RP105	88	RP394Si BK	112	RP3129Si	113
RP53	97	RP108	94	RP394Si GR	113	TR025	110
RP54	54	RP109Si	59	RP394Si LG	113	TR050	110
RP56	76	RP110Si	38, 60	RP404	113		
		RP111Si	60	RP404a	113		

Refer page 116 for Quick Product Reference

## Guarantee

Raven seals are guaranteed for 2 years against defects in materials and workmanship, provided seals are fitted in accordance with manufacturer's specifications. Defective goods identified by Raven will be replaced. However, NO claim for work done thereon or damage incurred will be allowed.

Self-adhesive backed; closed cell and open cell foam tape seals are not guaranteed. Defective goods identified by Raven may be replaced. Experience has shown that even for one and the same objective, the exact requirements may vary due to site and environmental conditions that are outside Raven Products control; this includes the surfaces to which self-adhesive products are being installed.

All technical data and recommendations, although based upon our research and believed to be reliable, is given in good faith but without warranty. It is understood that users will independently determine the suitability of all products shown or specified herein for their purposes and as such Raven Products Pty. Ltd. accepts no liability.

## Copyright ©

The tradename Raven and its registered trademarks remain the property of Raven Products Pty. Ltd., Australia. Product numbers, drawings and technical details are Raven copyright. Reproduction is by written permission only and must accompany the Raven brand and copyright acknowledgement.

Raven Products Pty. Ltd. reserves the right to alter, delete or make obsolete any product shown in this catalogue or website, without prior notice.

## Disclaimer

In this catalogue there are some references to various national and international standards and building codes. No Raven copyright is implied or intended. References are a guide only. It is understood that users of this catalogue will obtain the most current building code and or standards for their intended purposes at all times.

## Images

Raven Products have been used in thousands of projects world-wide. Pictured on the front cover from left to right are: La Trobe University, One Central Park and SAHMRI.

FOR ALL YOUR STAIR EDGING AND  
TACTILE NEEDS VISIT [WWW.DTAC.COM.AU](http://WWW.DTAC.COM.AU)

**DTAC<sup>®</sup>**





## **Raven Products Pty. Ltd.**

### **Head Office and Factory**

18 - 22 Aldershot Road  
Lonsdale, South Australia 5160  
Australia

PO Box 67  
Lonsdale, South Australia 5160  
Australia

**T** +61 8 8384 5455

**F** +61 8 8382 8885

### **Sales Enquiries**

**T** 1800 888 123 Free call anywhere in Australia

**E** [sales@raven.com.au](mailto:sales@raven.com.au)

### **Technical Advice**

**E** [tech.advice@raven.com.au](mailto:tech.advice@raven.com.au)

[www.raven.com.au](http://www.raven.com.au)