

# Astragals

## Meeting Stile Seals for Frameless Glass



### RP42, RP103, RP104



Clear polycarbonate astragal and perimeter seals specifically designed for frameless glass doors. The woven pile sealing strip is combined with a weather fin to form an effective weather and energy seal.

Use in conjunction with Raven brush strip door bottom seals RP2b, RP74 and threshold plates.

#### Location:

**RP42** Meeting stiles of 15mm thick frameless glass doors.

**RP103** Meeting stiles of 10mm thick frameless glass doors.

**RP104** Meeting stiles of 12mm thick frameless glass doors.

**Min/Max Gap:** 7mm to 8mm (prior to installation).

**Fixing:** Self adhesive. *Note: Contact surface must be clean, smooth and if painted, well cured. Self adhesive seals will not adhere to oiled or alkyd finishes or to easy clean wash and wear paint surfaces.*

**Seal:** Clear high impact UV stabilised polycarbonate body with black polypropylene pile with weather fin.

**Sizes:** 3000mm.

#### Approvals

**Energy** NCC Pt. 3.12.3.3 & J3.4.

#### RP42

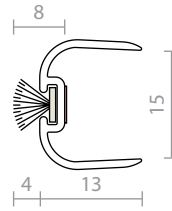

#### RP103

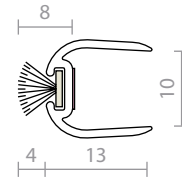

#### RP104

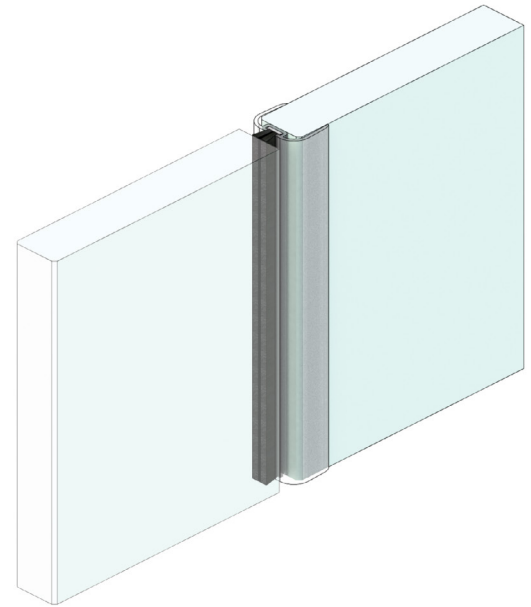
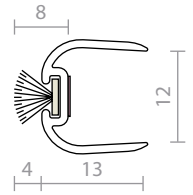

### RP79, RP79Si, RP79H, RP88



Aluminium astragal seals designed for frameless glass doors. The woven pile sealing strip in RP79 and RP88 is combined with a weather fin to form an effective weather and energy seal. RP79Si utilises silicon rubber fins for medium temperature smoke door applications.

Use in conjunction with Raven brush strip door bottom seals RP2b, RP74 and threshold plates.

#### Location:

**RP79, RP79Si, RP79H** Meeting stiles of 12mm thick frameless glass doors.

**RP88** Meeting stiles of 10mm thick frameless glass doors.

#### Min/Max Gap:

**RP79, RP79Si, RP88** 8mm to 9mm (prior to installation).

**RP79H** 8mm to 12mm (prior to installation).

**Finish:** Satin clear (silver) anodised aluminium (15µm).

**Fixing:** Self adhesive. *Note: Contact surface must be clean, smooth and if painted, well cured. Self adhesive seals will not adhere to oiled or alkyd finishes or to easy clean wash and wear paint surfaces.*

#### Seal:

**RP79, RP88** Black polypropylene pile with weather fin.

**RP79Si** RP371Si. Grey silicon rubber (SE).

**RP79H** RP640. Black TPE.

**Sizes:** Available in stock lengths.

#### Approvals

**Energy** NCC Pt. 3.12.3.3 & J3.4.



**Fire** Gasket flammability index 1 when tested to AS1530.2.

**Smoke** NCC Spec. C3.4 for smoke doors.



**Fire** Gasket flammability index ≤ 5 when tested to AS1530.2.

**Smoke** NCC Spec. C3.4 for smoke doors.

#### RP79

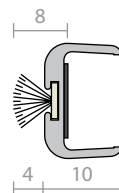

#### RP88

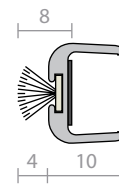

#### RP79Si

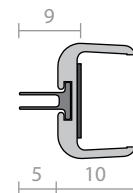

#### RP79H

