

1 Mark door

For entrance and privacy, Using the drilling template, mark the door face and door end at the height required

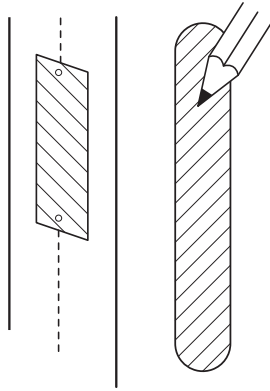

2 Cut pocket

Using a drill and router, cut and remove slider handle pocket from the door

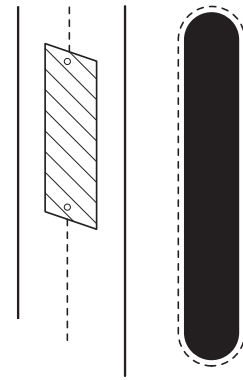

3 Drill out forend.

For entrance and privacy, Using a 12mm drill bit, drill from the door face through to the handle pocket, repeat until most material has been removed and the rest using a chisel.

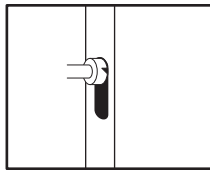

4 Rebate forend

For entrance and privacy, Using a chisel, rebate 3mm deep or until the faceplate site flush with the door face, drill pilot holes for installing forended.

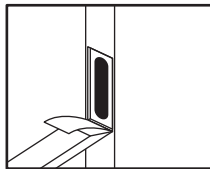

5 Install forend.

For entrance and privacy, Using a phillips head screwdriver install forend into rebated hole.

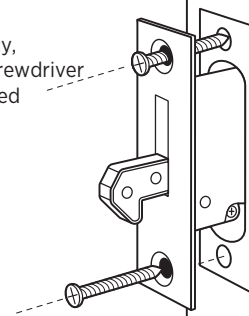

6 Install handles

In the 'Locked' position install handles into door pocket
Aligning pins and making sure to align the loop on the lock with the pin (a) on the handle body. Secure using supplied phillips head screws.

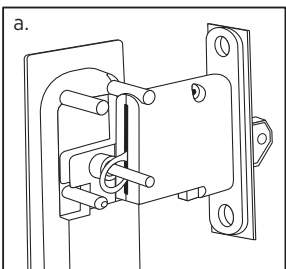

7 Install finger-pull

Install finger-pull by drilling 25mmØ hole, 23mm deep that aligns with the base of the handle, or low enough to clear the striker plate. Install finger-pull and secure with the supplied screw.

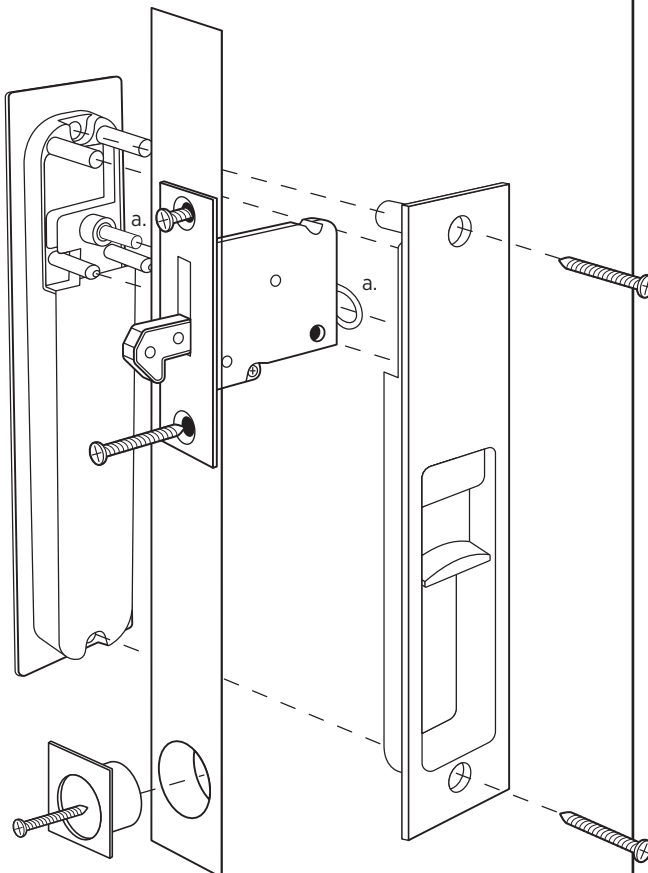

8 Mark striker and rebate

For entrance and privacy, Align the striker using template and mark on the door jamb, rebate to or until the striker is flush with the door jamb.

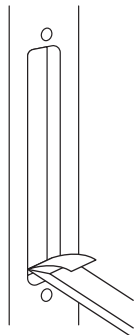

9 Install and adjust striker

For entrance and privacy, Install the striker into the door jamb, securing with supplied screws, the striker is adjustable to allow for correct alignment with the hook of the lock. To adjust, loosen the lower screw and move the striker internals up or down until you find the correct position.



