



ARCHITECTURAL DOOR HARDWARE

2023/2024



www.sylvan.co.nz



about G D Rutter

G D Rutter Ltd was founded in 1930 by George Daniel Rutter, as an importing agent specialising in builder's hardware. Three generations and 93 years later G D Rutter Ltd has grown to be one of New Zealand's leading suppliers of door and cabinet hardware to the hardware trade under the Sylvan brand name.

Throughout the 93 years of business there has always been a strong family influence with the emphasis on customer satisfaction and product quality. Now G D Rutter Ltd is managed by the 3 grandsons of George Daniel, who have grown up with hardware products and being involved in the business from a very young age. This early involvement in hardware products has ensured that the leadership of G D Rutter Ltd has strong product and technical knowledge together with superior customer service, these qualities set our company apart from many other hardware suppliers in New Zealand.

Designing and sourcing products that suit your environment is a key aspect of the Sylvan brand. Our design and engineering team puts a great deal of effort into ensuring the products we supply meet New Zealand's building standards and their intended purpose.

Our range of hardware products are available from all leading hardware stores, throughout New Zealand. Don't hesitate to contact us if you have any queries regarding any product within the Sylvan range.





SL36E
Digital Smart Lock



- For Wooden and Aluminium doors
- 30, 35, 40, 45, 60 & 70mm locks sold separately
- Door thickness 35-65mm
- IP66 rated
- Finish: Black, Silver

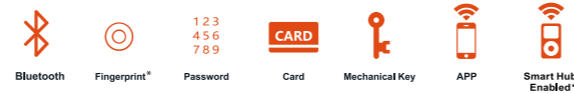

SL40E
Digital Smart Lock



- For Wooden and Aluminium doors
- Adjustable latch 60-70mm
- Door thickness 35-60mm
- Hole prep size 54mm
- IP55 rated
- Finish: Black, Silver

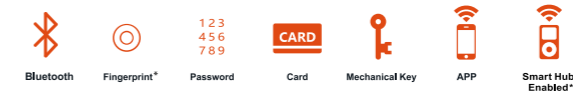

SL39E
Smart Dead Lock



- For Wooden and Aluminium doors
- Adjustable deadbolt 60-70mm
- Door thickness 35-55mm
- Hole prep size 54mm
- IP55 rated
- Locked by pressing the # key
- Finish: Black, Silver

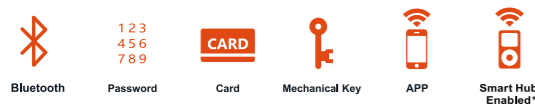

Sylvan Smart Disc

- Programmable as a RF card for any Sylvan Smart Lock.
- Overall size 2.6 x 2.6mm



SL41E
Digital Smart Lock

- For Wooden and Aluminium doors
- 60mm Mortice Lock included
- Door thickness 35-60mm
- IP55 rated
- Finish: Black, Silver

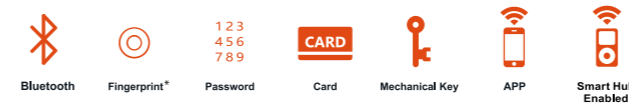

Smart Lock Scar Plate

- Scar Plates are designed to cover a range of holes and suitable for Sylvan SL36 & SL41 electronic Smart Locks
- Finish: Black, Stainless Steel

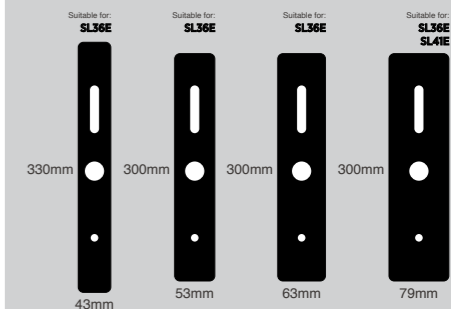

SmartHub* enabled, connect multiple smart locks to the same device within a 10 meter range**. *sold separately **depending on structure and signal interference.



XP8 Oval

XP9 Round

- Black Carbon Fibre
- Overall length: 600mm
- Screw centres: 420mm
- 316 Marine Grade Stainless Steel posts and fittings suitable for outside use
- Pillar Finishes: SS, BO



XP5

- Available in Jarrah or Kwila
- Overall length: 540mm
- Screw centres: 250mm
- 316 Marine Grade Stainless Steel posts and fittings suitable for outside use
- Pillar Finishes: SS, BO



XP6

- Available in Jarrah or Kwila
- Overall length: 600mm, 1200mm
- Screw centres: 420mm, 720mm, 1020mm (3 pillars)
- 316 Marine Grade Stainless Steel posts and fittings suitable for outside use
- Pillar Finishes: SS, BO



DP1

- Diameter: 32mm
- Overall length: 520mm
- Screw centres: 400mm
- Finish: 304 Grade BSS



DP3

- Diameter: 25mm
- Overall length: 430mm
- Screw centres: 400mm
- Finish: 304 Grade BSS



DP6

- Oval tube bar pull
- Overall length: 600mm or 900mm
- Screw centres: 420mm or 720mm
- Finish: 316 Grade BSS



DP4

- Rectangular tube pull
- Profile: 40mm x 20mm
- Overall length: 600mm
- Screw centres: 580mm
- Finish: 316 Grade BSS, Black (special order)



DP5

- Rectangular tube bar pull
- Profile: 40mm x 20mm
- Overall length: 600mm
- Screw centres: 450mm
- Finish: 316 Grade BSS, Black (special order)



DP7

- Offset rectangular tube pull
- Profile: 40mm x 20mm
- Overall length: 600mm
- Screw centres: 580mm
- Finish: 316 Grade BSS



Kit Includes, Mortice Lock, Euro Cylinder, Double Turn, Escutcheon



FDKIT1

- Kit Includes:
- Door Pull DP1
- Round Escutcheon I-ESC4E
- Round Double Turn I-TTD4
- Euro Mortice Sashlock 60mm backset S785/60
- Euro Cylinder & Turn 68mm overall

FDKIT3

- Kit Includes:
- Door Pull DP3
- Round Escutcheon I-ESC4E
- Round Double Turn I-TTD4
- Euro Mortice Sashlock 60mm backset S785/60
- Euro Cylinder & Turn 68mm overall

FDKIT4

- Kit Includes:
- Door Pull DP4
- Square Escutcheon I-ESC5E
- Square Double Turn I-TTD5
- Euro Mortice Sashlock 60mm backset S785/60
- Euro Cylinder & Turn 68mm overall

FDKIT5

- Kit Includes:
- Door Pull DP5
- Square Escutcheon I-ESC5E
- Square Double Turn I-TTD5
- Euro Mortice Sashlock 60mm backset S785/60
- Euro Cylinder & Turn 68mm overall

FDKIT6

- Kit Includes:
- Door Pull DP600
- Round Escutcheon I-ESC4E
- Round double turn I-TTD4
- Euro Mortice Sashlock 60mm backset S785/60
- Euro Cylinder & Turn 68mm overall



Digital Locks

Ideal for entrance doors, garages, sheds, shared spaces.

S201.S

- Mechanical digital entrance lock suitable for residential use.
- Easy code programmable lock
- Supplied with a 60mm backset
- Door thickness 35-55mm
- Not suitable for use in high salt and sulphur environments.
- Finish: Satin Chrome Plate



Push and pull plates

304 grade stainless steel, suitable for commercial or residential use.



- Produced in 1.8mm Stainless Steel
- 300 x 100 x 1.8mm face fixed.
- Embossed wording.
- Solid stainless steel handle
- Includes all stainless steel fixing screws
- Finishes: Stainless Steel, Black (PP1 & PP3 Only)



Double Turn Kit

The kit includes the following items:

- Euro escutcheon - square or round
- 5 pin euro cylinder and turn (6 pin available on request)
- Overall length: cylinder 68mm for 5 pin
- Euro profile mortice lock S785: 60mm backset, 85mm key and turn separation, 21.5mm single throw deadbolt, reversible latch bolt, key retraction of latch
- Double thumb turn with 27mm knob
- Maximum door thickness: 32-45mm
- Plates: 56.5 x 56.5mm square option, 56.5mm diameter round option
- Finish: SNP



Outside

FDKIT4



HSI-TTD5K

HSI-TTD4K

Centro Entrance Kits

All Centro lever handle shapes are available in kit form.

The kit includes the following items:

- Centro selected lever handle on a long backplate
- 5 pin euro cylinder and turn (6 pin available on request)
- Overall length: cylinder 68mm for 5 pin
- Euro profile mortice lock S785: 60mm backset, 85mm key separation, 21.5mm single throw deadbolt, reversible latch bolt, key retraction of latch
- Door thickness: 32-45mm
- Finish: SNP



Outside



Inside

Inside

Refer page 12-16 for Centro lever handle options.

All Centro lever shapes are available in kit form.

- Asti: HSI-90EK
- Monza: HSI-91EK
- Savona: HSI-92EK
- Como: HSI-93EK
- Andora: HSI-94EK
- Murano: HSI-95EK
- Trento: HSI-85EK

Entrance Sets



EH805

- Material: Zinc
- 270mm overall for handle
- 170mm b/c
- 51mm hole prep
- Finish: SNP



EH710

- Material: Brass
- 295mm overall for handle
- 208mm b/c
- Finish: SCP



EH707

- Material: Zinc
- 284mm overall
- Finish: SCP, Black



*Please refer to back page for black finishes warranty information

- Operation: Latch operated by thumb lever from outside. Round knob inside
- Security: Heavy duty double cylinder deadbolt with reinforced security rose
- Door thickness: 34-57mm • Backset: Adjustable 60 or 70mm

- EH710 & EH707 require 54mm holes through door required for deadbolt and handleset
- EH805 requires a 51mm hole through door.
- EH707 - Adjustable bottom hole spacing from 200-230mm c/c from latch.

Centro Entrance Kits

All Centro lever handle shapes are available in kit form.

The kit includes the following items:

- Centro selected lever handle on a small backplate
- Euro escutcheon (round or square)
- 5 pin euro cylinder and turn (6 pin available on request)
- Overall length: 68mm for 5 pin
- Euro profile mortice lock S785: 60mm backset, 85mm key and turn separation, 21.5mm single throw deadbolt, reversible latch bolt, key retraction of latch
- Door thickness: 32-45mm
- Plates: 56.5 x 56.5mm square option, 56.5mm diameter round option
- Finish: SNP

Refer page 12-16 for Centro lever handle options.

All Centro lever shapes are available in kit form.

- Asti: HSI-90RK
- Monza: HSI-91RK
- Savona: HSI-92RK
- Como: HSI-93RK
- Andora: HSI-94RK
- Murano: HSI-95RK

Outside

Outside



Inside

Savona

I-92R



No handing required

I-92R



I-92BK



Privacy option

Como

I-93R



No handing required

I-93BK



Privacy option

Andora

I-94R



No handing required

I-94BK



Privacy option

- Passage & Privacy lever furniture
- Concealed screw fixing
- Rose diameter: 56mm x 56mm
- Privacy function is available by integrated privacy on the rose of the handle or Privacy function by separate turn and emergency release. Refer page 20 for turn options.
- 60mm latch backset is included with all Passage & Privacy sets

- Door thickness 30-50mm
- All curved lever dummy trim handles are handed - refer page 58 for handing diagram
- Dummy trim can be installed back to back for use on French doors
- Finish: SNP - all handle shapes, Graphite - Savona, Asti only

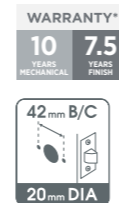

Savona

I-92L



I-92E



I-92E.85



I-92UP



Como

I-93L



I-93E



I-93E.85



I-93UP



Andora

I-94L



I-94E



I-94E.85



I-94UP



Lever keyhole

- Lever keyhole stamped
- Use with Sylvan S717, S795 Lever key mortice locks, either 2" or 3" lock body
- 57mm spacing between spindle and lever keyhole
- Finish: SNP



Euro keyhole

- Euro profile keyhole stamp
- Use with Sylvan S735 euro key mortice lock, either 2" or 3" lock body
- Use with Sylvan S725 euro double cylinder or S725 euro cylinder and turn
- 48mm spacing between spindle and euro keyhole
- Finish: SNP



Euro keyhole 85mm

- Euro profile keyhole stamp
- Use with Sylvan S785, S726 euro mortice lock
- Use with Sylvan S725 euro double cylinder or S725 euro cylinder and turn
- 85mm spacing between spindle and euro keyhole
- Finish: SNP



Unpunched

- Unpunched backplate suitable for use in passage situation
- Use with Sylvan MLS latch - 60 or 70mm
- Finish: SNP
- All handles overall backplate measurements: 45mm (w) x 240mm (h)

Asti

I-90R



Graphite Finish
No handing required

I-90R



I-90BK



Privacy option

Monza

I-91R



Handing required for Dummy Trim only.
Refer to back cover for handling diagram.

I-91BK



Privacy option

Murano

I-95R



Handing required for Dummy Trim only.
Refer to back cover for handling diagram.

I-95BK



Privacy option

- Passage & Privacy lever furniture
- Concealed screw fixing
- Rose diameter: 56mm
- Privacy function is available by integrated privacy on the rose of the handle or Privacy function by separate turn and emergency release. Refer page 20 for turn options.
- 60mm latch backset is included with all Passage & Privacy sets

- Door thickness 30-50mm
- All curved lever dummy trim handles are handed - refer page 58 for handling diagram
- Dummy trim can be installed back to back for use on French doors
- Finish: SNP - all handle shapes, Graphite - Savona, Asti only

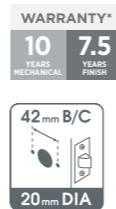

Asti

I-90L



I-90E



I-90E.85



I-90UP



Monza

I-91L



I-91E



I-91E.85



I-91UP



Murano

I-95L



I-95E



I-95E.85



I-95UP



Lever keyhole

- Lever keyhole stamped
- Use with Sylvan S717, S795 Lever key mortice locks, either 2" or 3" lock body
- 57mm spacing between spindle and lever keyhole
- Finish: SNP



Euro keyhole

- Euro profile keyhole stamp
- Use with Sylvan S735 euro key mortice lock, either 2" or 3" lock body
- Use with Sylvan S725 euro double cylinder or S725 euro cylinder and turn
- 48mm spacing between spindle and euro keyhole
- Finish: SNP



Euro keyhole 85mm

- Euro profile keyhole stamp
- Use with Sylvan S785, S726 euro mortice lock
- Use with Sylvan S725 euro double cylinder or S725 euro cylinder and turn
- 85mm spacing between spindle and euro keyhole
- Finish: SNP



Unpunched

- Unpunched backplate suitable for use in passage situation
- Use with Sylvan MLS latch - 60 or 70mm
- Finish: SNP
- All handles overall backplate measurements: 38mm (w) x 239mm (h)

Trento

I-85R



I-85BK



Privacy option

Handing required for Dummy Trim only.
Refer to back cover for handling diagram.

- Passage & Privacy lever furniture
- Concealed screw fixing
- Rose diameter: 56mm x 56mm
- Privacy function is available by integrated privacy on the rose of the handle or Privacy function by separate turn and emergency release. Refer page 20 for turn options.
- 60mm latch backset is included with all Passage & Privacy sets

- Door thickness 30-50mm
- All curved lever dummy trim handles are handed – refer page 58 for handling diagram
- Dummy trim can be installed back to back for use on French doors
- Finish: SCP

WARRANTY*
10 YEARS MECHANICAL 7.5 YEARS FINISH

42mm B/C
20mm DIA

I-85L



I-85E



I-85E.85



I-85UP



Lever keyhole

- Lever keyhole stamped
- Use with Sylvan S717, S795 Lever key mortice locks, either 2" or 3" lock body
- 57mm spacing between spindle and lever keyhole
- Finish: SCP

Euro keyhole

- Euro profile keyhole stamp
- Use with Sylvan S735 euro key mortice lock, either 2" or 3" lock body
- Use with Sylvan S725 euro double cylinder or S725 euro cylinder and turn
- 48mm spacing between spindle and euro keyhole
- Finish: SCP

Euro keyhole 85mm

- Euro profile keyhole stamp
- Use with Sylvan S785, S726 euro mortice lock
- Use with Sylvan S725 euro double cylinder or S725 euro cylinder and turn
- 85mm spacing between spindle and euro keyhole
- Finish: SCP

Unpunched

- Unpunched backplate suitable for use in passage situation
- Use with Sylvan MLS latch – 60 or 70mm
- Finish: SCP

Porto

I-21PS



I-21BK



Privacy option
No handing required

- 304 Grade Stainless Steel lever
- Passage & Privacy lever furniture
- Concealed screw fixing
- Rose diameter: 56mm
- 60mm latch is included with all Passage & Privacy sets
- Handle length: 130mm
- Door thickness 30-56mm
- Dummy trim can be installed back to back for use on French doors
- Entrance Kits also available
- Finish: Stainless Steel

WARRANTY*
10 YEARS MECHANICAL 7.5 YEARS FINISH

42mm B/C
20mm DIA

Lagos

I-20PS



WARRANTY*
10 YEARS MECHANICAL 7.5 YEARS FINISH

42mm B/C
20mm DIA

I-20BK



Privacy option
No handing required

WARRANTY*
10 YEARS MECHANICAL 2 YEARS FINISH

- 304 Grade Stainless Steel lever
- Passage & Privacy lever furniture
- Concealed screw fixing
- Rose diameter: 56mm
- 60mm latch is included with all Passage & Privacy sets
- Door thickness 30-56mm

- Handle length: 133mm
- Dummy trim can be installed back to back for use on French doors
- Entrance Kits also available
- Finish: Stainless Steel, Black

Sylvan escutcheons are suitable for use with centro lever handles and stainless steel lever handles

I-ESC6 O



Oval Euro Keyhole Escutcheon

- Diameter: 51mm
- Finish: SNP



I-ESC6 E



Round Euro Keyhole Escutcheon

- Diameter: 51mm
- Use with Sylvan euro cylinder S725
- Finish: SNP



I-ESC8 E



Euro Profile Keyhole Escutcheon

- Diameter: 55mm
- Use with Sylvan Stainless Steel lever handles, Lagos & Sylvan S725 Euro Cylinders
- Finish: SS, Black via special order



I-ESC4 O



Oval Cylinder Keyhole Escutcheon

- Diameter: 56.6mm
- Finish: SCP, SNP



I-ESC4 E



Euro Profile Keyhole Escutcheon

- Diameter: 56.6mm
- Use with Sylvan euro cylinder S725
- Finish: SCP, SNP



I-ESC5 O



Oval Cylinder Keyhole Escutcheon

- Backplate: 56.6 x 56.6mm
- Finish: SNP



I-ESC5 E



Euro Profile Keyhole Escutcheon

- Backplate: 56.6 x 56.6mm
- Use with Sylvan euro cylinder S725
- Finish: SNP, CP



I-ESC5 L



Lever Keyhole Escutcheon

- Backplate: 56.6 x 56.6mm
- Finish: SNP



I-ESC9 E



Euro Profile Keyhole Escutcheon

- Diameter: 55mm x 55mm
- Use with Sylvan Stainless Steel lever handles, Porto
- Finish: SS, Black via special order



I-ESC7 E



Square Euro Keyhole Escutcheon

- Backplate: 51 x 51mm
- Use with Sylvan euro cylinder S725
- Finish: SNP



I-ESC7.O



Square Oval Keyhole Escutcheon

- Backplate: 51 x 51mm
- Finish: SNP



	Lever Key	Euro Key	Euro 85 Spacing	Unpunched
SQUARE ROSE	 I-92R I-93R I-94R I-21PS	 I-92E I-93E I-94E	 I-92E.85 I-93E.85 I-94E.85	 I-92UP I-93UP I-94UP
ROUND ROSE	 I-90R I-91R I-95R I-85R I-20PS	 I-90E I-91E I-95E I-85E	 I-90E.85 I-91E.85 I-95E.85 I-85E.85	 I-90UP I-91UP I-95UP I-85UP
MORTICE LOCKS	 S791/2.5" & S791/3" S721/46	 S717/2.5" & S717/3"	 S735/2.5" & S735/3"	 S726/46 & S726/51
	 S785/45 S785/50 S785/60 S785/70 S731/2.5"	 S795/2.5" & S795/3"		 S785/45 S785/50 S785/60 S785/70
EURO CYLINDERS	 S725TT/S725DBL/S725BKTT	 S725TT/S725DBL S725BKTT	 S725TT/S725DBL S725BKTT	
ESCUTCHEONS	 I-ESC5 L I-ESC5 E I-ESC9 E I-ESC4 L I-ESC4 E I-ESC4 E			
MORTICE LATCH	 MLS708 & MLS608			 MLS708 & MLS608

Privacy for bathrooms

I-TT3



Bathroom Privacy Turn

- Thumb turn and emergency release
- Diameter: 56.6mm
- Spindle: 6mm
- Concealed screw fixing
- Finish: SS

I-TT4



Bathroom Privacy Turn

- Thumb turn and emergency release
- Diameter: 56.6mm
- Spindle: 6mm
- Concealed screw fixing
- Finish: SNP

I-TT5

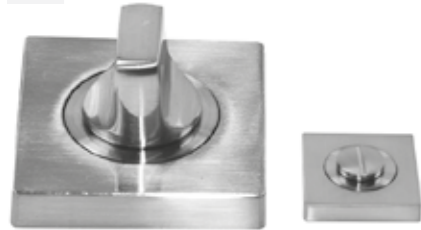

Bathroom Privacy Turn

- Thumb turn and emergency release
- Backplate: 56.6 x 56.6mm
- Spindle: 6mm
- Concealed screw fixing
- Finish: SNP

I-TT6



Bathroom Privacy Turn

- Turn and emergency release
- Diameter: 51mm
- Spindle: 6mm
- Finish: SNP

I-TT7



Bathroom Privacy Turn

- Turn and emergency release
- Backplate: 51 x 51mm
- Spindle 6mm
- Finish: SNP

Thumb turns

I-TT8



Round Turn

- Spindle: 6mm star design
- Backplate: 51mm
- Finish: SNP

I-TT9



Square Turn

- Spindle: 6mm star design
- Backplate: 51mm
- Finish: SNP

WARRANTY*
10 YEARS MECHANICAL
7.5 YEARS FINISH

WARRANTY*
10 YEARS MECHANICAL
7.5 YEARS FINISH

Privacy Kits for Bathrooms



HSI-Bathset

Kit Includes:

- **I-TT4** Round turn/backplate and emergency release; (56.6mm)

- **I-BATH 2** 60mm latch, Spindle: 6mm, if 70mm latch required order HSI-BATHSET4

Finish SNP



HSI-Bathset 6

Kit Includes:

- **I-TT6** Round turn/backplate and emergency release; (51mm)

- **I-BATH 2** 60mm latch, Spindle: 6mm

Finish SNP



HSI-Bathset 2

Kit Includes:

- **I-TT5** Round turn, square backplate and emergency release; (56.6mm)

- **I-BATH 2** 60mm latch, Spindle: 6mm, if 70mm latch required order HSI-BATHSET5

Finish SNP



HSI-Bathset 7

Kit Includes:

- **I-TT7** Round turn, square backplate and emergency release; (51mm)

- **I-BATH 2** 60mm latch, Spindle: 6mm

Finish SNP

Double turn sets

I-TTD4



Double turn, round backplate

- Spindle: 8mm
- Backplate: 56.6mm
- Finish: SNP

I-TTD5



Double turn, square backplate

- Spindle: 8mm
- Backplate: 56.6mm
- Finish: SNP

WARRANTY*
10 YEARS MECHANICAL
7.5 YEARS FINISH

Rockford

Tubular Leverset



▲ BK E16BK

▲ PS E16PS ▲ DT E16DT

- Securefix technology provides added strength
- Passage, Privacy & Dummy trim
- Door thickness: 30-45mm
- Concealed screw fixing
- E16 complies with NZ disability standards
- Standard 54mm hole prep

- 60-70mm adjustable latch
- Dummy trim handles can be installed back to back for use on French doors
- Easy to install
- Finish: SNP



Beaumont

Tubular Leverset



▲ BK E15BK

▲ PS E15PS ▲ DT E15DT

- Securefix technology provides added strength
- Passage, Privacy & Dummy trim
- Door thickness: 30-45mm
- Concealed screw fixing
- Standard 54mm hole prep

- 60-70mm adjustable latch
- Dummy trim handles can be installed back to back for use on French doors
- Easy to install
- Finish: SNP



Newton

Tubular Leverset



▲ ET E39ET

- Functions: Entrance, Bathroom, Passage, Dummy Trim
- Door thickness: 30-45mm
- Matching deadbolt available EDB6
- Backset: Adjustable 60 or 70mm
- Handing: Not required

- Dummy Trim can be back to back for use on French doors
- Low rotation latch. Solid construction
- Turn button to operate entrance and bathroom functions from the inside
- Finish: SCP



▲ BK E39BK



▲ PS E39PS ▲ DT E39DT

Oakland

Tubular Leverset



▲ BK E46BK



▲ PS E46PS ▲ DT E46DT



▲ ET E46ET

- Functions: Entrance, Bathroom, Passage, Dummy Trim
- Door thickness: 30-45mm
- Matching deadbolt available EDB5
- Backset: Adjustable 60 or 70mm
- Handing: Only required for Dummy Trim
- Dummy Trim can be back to back

- for use on French doors
- Low rotation latch. Solid construction
- Turn button to operate entrance and bathroom functions from the inside
- Finish: SNP



Handing required for dummy only. Refer page 58 for handling

Dalton

Tubular Leverset

NEW

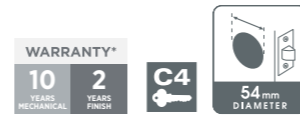

▲ BK E64BK



▲ PS E64PS ▲ DT E64DT

▲ ET E64ET

- Functions: Entrance, Bathroom, Passage, Dummy Trim
- Door thickness: 30-45mm
- Backset: Adjustable 60 or 70mm
- Handing: Not required
- Dummy Trim can be back to back for use on French doors
- Low rotation latch

- Suitable for DIY and trade, removable handles for easy installation
- Concealed screw fixing on all functions
- Turn button to operate entrance and bathroom functions from the inside
- Finish: Black

Denver

Tubular Leverset

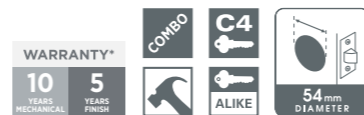

▲ BK E60BK



▲ PS E60PS ▲ DT E60DT

▲ ET E60ET

- Functions: Entrance, Bathroom, Passage, Dummy Trim
- Door thickness: 30-45mm
- Backset: Adjustable 60 or 70mm
- Handing: Not required
- Dummy Trim can be back to back for use on French doors
- Low rotation latch

- Suitable for DIY and trade, removable handles for easy installation
- Concealed screw fixing on all functions
- Turn button to operate entrance and bathroom functions from the inside
- Finish: SCP

Richmond

Tubular Leverset

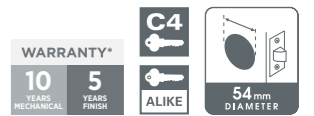

▲ BK E50BK



▲ PS E50PS ▲ DT E50DT

▲ ET E50ET

- Functions: Entrance, Bathroom, Passage, Dummy Trim
- Door thickness: 30-45mm
- Backset: Adjustable 60 or 70mm
- Handing: Not required
- Dummy Trim can be back to back for use on French doors
- Low rotation latch

- Suitable for DIY and trade, removable handles for easy installation
- Concealed screw fixing on all functions
- Turn button to operate entrance and bathroom functions from the inside
- Finish: SCP

Seattle

Cylindrical Leverset



▲ BK E30BK



▲ PS E30PS ▲ DT E30DT

▲ ET E30ET

- Functions: Entrance, Bathroom, Passage, Dummy Trim
- Door thickness: 28-43mm
- Backset: 60 & 70mm latches supplied
- Chassis: Threaded on both sides for easy alignment and solid fixing

- Push button and panic release on Entrance and Bathroom inner lever handle
- Handing required for Entrance/Bathroom and Dummy Trim - refer page 58 for handing diagram
- Finish: SCP

Handing required. Refer page 58 for handing

NB: Entrance Set image is outside view left-hand

Houston
Tubular Leverset



▲ BK E37BK



▲ PS E37PS ▲ DT E37DT



▲ ET E37ET

- Functions: Entrance, Bathroom, Passage, Dummy Trim
- Door thickness: 30-45mm
- Backset: Adjustable 60 or 70mm
- Handing: Not required
- Dummy Trim can be back to back for use on French doors
- Low rotation latch
- Suitable for DIY and trade, removable handles for easy installation
- Concealed screw fixing on all functions
- Turn button to operate entrance and bathroom functions from the inside
- Finish: SCP

Leo I-10



Orion I-11



Virgo I-12



- All lever handle shapes available with Euro key 85mm spindle separation, unpunched passage function and patio function
- Standard backplate size 202mm long suits ISEO 741 lock
- 240mm backplate suits ISEO 781 and 723 Performa 3 point lock
- Reversible handing
- Ball assisted cassettes included for smooth and positive lever action
- Stainless steel through bolt fixing screws
- Concealed screw fixing on outside of door
- Grub screw locked split spindle for added strength
- Designed in New Zealand for New Zealand and Australian building requirements
- Finishes: SNP, Black, White, Grey
- Other powder coat colours are available on request



Black



Grey



White



SNP



Sylvan Aluminium Door handle installed with Iseo 741 lock and I-10 Leo handle

planning your next project?

find our full range and more online

scan the code



www.sylvan.co.nz

Tapered
Lever Handle
NEW
3585

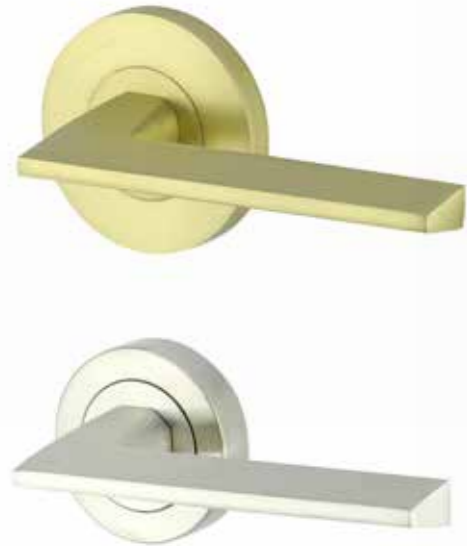

- No need to count Passage and Privacy options as both options are supplied in the same box.
- Supplied with a 60mm latch
- 24-54mm hole
- Rose Diameter 63mm
- Concealed screw fixing
- Stainless steel ball bearing mechanism for added strength
- Manufactured in Zinc
- Black, Satin Chrome, Satin brass finish (ex stock)



Linear
Lever Handle
NEW
3580

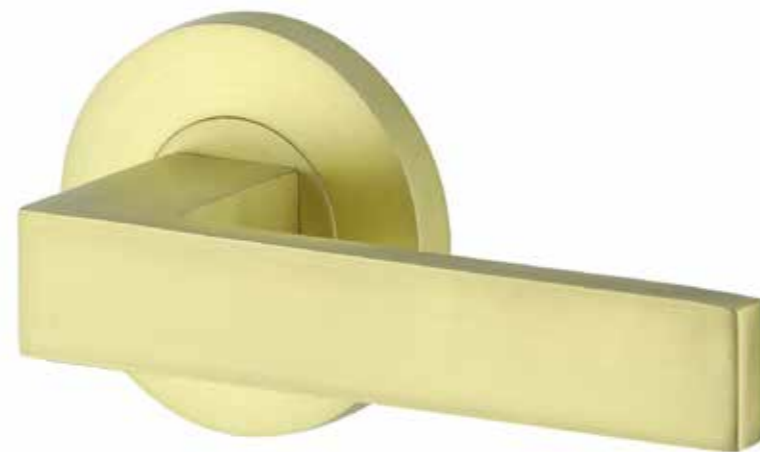

- No need to count Passage and Privacy options as both options are supplied in the same box.
- Supplied with a 60mm latch
- 24-54mm hole
- Rose Diameter 63mm
- Concealed screw fixing
- Stainless steel ball bearing mechanism for added strength
- Manufactured in Zinc
- Black, Satin Chrome, Satin brass finish (ex stock)



Curved Lever Set on 62mm Rose
NEW
3009

- Passage Lever Set
- Back plate diameter: 62mm
- Projection: 52mm facefixed
- Manufactured in: Brass
- Finishes: Polished Brass, Satin Chrome (ex stock)



Face Fixed Knob on 52mm Rose
NEW
3010

- Passage door knob
- 55mm diameter
- 73mm projection
- Manufactured in: Brass
- Finish: Polished Brass, Satin Chrome (ex stock)



Victorian Lever Set
NEW
3094

- Passage Lever Set
- 150 x 42mm
- Manufactured in: Brass
- Finishes: Matt Black, Polished Brass, (ex stock) Satin Chrome, Antique Copper, Chrome (Special Order in)



Victorian Lever on Dovetail
NEW
4176

- Passage Lever Set
- 200 x 48mm
- Manufactured in: Brass
- Finishes: Matt Black, Polished Brass, Satin Chrome, (ex stock) Antique Copper, Chrome (Special Order in)



deadbolts

Double or single cylinder

EDB1



Single Cylinder Deadbolt

- Operation: Key from outside. Thumb turn inside
- Backset: Adjustable 60 or 70mm
- Door thickness: 35-50mm
- Keying: May be keyed in pair with Sylvan entrance sets
- Finishes: PB, SS

WARRANTY*
10 YEARS MECHANICAL 5 YEARS FINISH
54mm DIAMETER
C4 ALIKE

EDB2



Double Cylinder Deadbolt

- Operation: By key from either side
- Backset: Adjustable 60 or 70mm
- Door thickness: 35-45mm
- Keying: May be keyed in pair with Sylvan entrance sets
- Comes complete with one-way fixing screws to prevent the lock from being removed from the inside
- Finishes: AB, PB, SS

WARRANTY*
10 YEARS MECHANICAL 5 YEARS FINISH
54mm DIAMETER
C4 ALIKE

EDB5



Single Cylinder Deadbolt

- Operation: Key from outside. Thumb turn inside
- Designed to match Oakland Entrance
- Backset: 60 or 70mm
- Hardened steel roller
- Door thickness: 35-50mm
- Concealed screw fixing
- Finish: SNP

WARRANTY*
10 YEARS MECHANICAL 7.5 YEARS FINISH
54mm DIAMETER
C4

EDB6



Single Cylinder Deadbolt

- Operation: Key from outside. Thumb turn inside
- Designed to match Newton Entrance
- Backset: 60 or 70mm
- Hardened steel roller
- Door thickness: 35-50mm
- Concealed screw fixing
- Finish: SCP

WARRANTY*
10 YEARS MECHANICAL 7.5 YEARS FINISH
54mm DIAMETER
C4

Quest

Cylindrical Knobset



ET E71ET DC E71DC

- Functions: Entrance, Double Cylinder Entrance, Bathroom, Passage, Dummy Trim
- Door thickness: 29-45mm
- Backset: 60 & 70mm latches supplied
- Handing: Reversible



PS E71PS DT E71DT

- Dummy Trim fixed from back of door
- Chassis: Threaded on both sides for easy alignment and solid fixing
- Push button and panic release on Entrance and Bathroom inner knob



BK E71BK

- Finishes: SS, PB or AB (Combination set not available in AB)

WARRANTY*
10 YEARS MECHANICAL 5 YEARS FINISH
54mm DIAMETER
C4 ALIKE COMBO

Vita

Cylindrical Knobset



ET E91ET

- Functions: Entrance, Bathroom, Passage, Dummy Trim
- Door thickness: 29-45mm
- Backset: 60 & 70mm latches supplied



PS E91PS DT E91DT

- Handing: Reversible
- Dummy Trim fixed from back of door
- Chassis: Threaded on both sides for easy alignment and solid fixing



BK E91BK

- Push button and panic release on Entrance and Bathroom inner knob
- Finishes: SS or PB

WARRANTY*
10 YEARS MECHANICAL 5 YEARS FINISH
54mm DIAMETER
C4 ALIKE COMBO

globe

Tubular Knobset



ET UE67ET

- Functions: Entrance, Bathroom, Passage, Dummy Trim
- Door thickness: 32-50mm
- Backset: 60 or 70mm latch



PS UE67PS DT UE67DT

- Dummy Trim fixed from back of door
- Supplied in boxed packs only. Not available in blister pack



BK UE67BK

- Turn button to operate entrance and bathroom functions from the inside
- Finishes: SS

amos

Tubular Knobset



BK E61BK

- Functions: Bathroom, Passage, Dummy Trim
- Door thickness: 30-50mm



PS E61PS

- Suitable as a replacement for door hardware with existing spindle holes from 10 to 30mm
- Backset: 60-70mm adjustable



DT E61DT

- Dummy Trim can be back to back for use on French doors
- Finish: SS

ET Entrance Lock

Latch bolt operated by key from outside, by knob inside. Inside handle always active. Deadlocking latch bolt.



DC Entrance Lock

Both knobs locked and unlocked by key. Deadlocking latch bolt.



BK Bathroom Lock

For bedroom, bathroom or toilet. Inside push button locks outer knob. Coin operated emergency release.



PS Passage Latch

For interior doors not requiring locking. Knobs are always active.

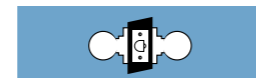

DT Dummy Trim

Fixed knob for wardrobe and cupboard doors. Use with roller bolt, magnetic catch or similar.



metal



LS76

Die-cast hammered Bronze knob and base
Die-cast White knob and base



wood



LSSRIM

Rimu knob, Gold Plated or Antique Brass base

LSSPINAB

Pine knob, Antique Brass base

LSSWHITEG

White knob, Gold Plated base



LS7

Rimu knob, Gold Plated or Antique Brass base



LS1

Rimu knob, Florentine Bronze base



LS9

White knob, Gold Plated or White base



Note: All knobs shown on this page have concealed screw fixing, are supplied with a 7.6mm spindle. Latch - MLS or ML7 sold separately, see page 36.



3 Lever Mortice Lock

S717/2.5"
S717/3"

- Backsets: 45mm & 58mm Brass deadbolt operated by key from either side
- Latch bolt by knob or lever from either side
- 96 Key differs
- Finish: Brass or NP forend & striker plate



Euro Profile Mortice Lock

S785

- Backset: 45, 50, 60, 70mm
- 85mm key and turn separation
- 21.5mm single throw deadbolt
- Reversible latch bolt
- Key retraction of latch
- Strike box available on request
- SS forend



Euro Profile Deadlock

S721/46

- Euro profile cylinder deadlock
- Backset: 30mm
- Bolt throw: 15mm with one key turn
- Latchbolt: SS forend



Rebated Forend Kit

S735R

- Suits: S735 euro profile lock & S795 5 lever mortice lock
- Finishes: Satin Brass, Nickel Matt



5 Lever Security Mortice Lock

S795/2.5"
S795/3"

- Backsets: 45 & 58mm
- Latch bolt reversible without opening case
- Deadbolt throws 16mm with one key turn
- 1000 Key differs
- Anti pick cartridge
- Brass or SS forend & striker plate



Euro Profile Mortice Lock

S735/2.5"
S735/3"

- Backsets: 45mm & 58mm
- Latchbolt reversible without opening case
- Deadbolt throws 16mm with one key turn
- Brass or SS forend & striker plate



Euro Profile Mortice Sashlock

S726/46
S726/51

- Backsets: 30 or 35mm
- Latchbolt: Brass, reversible without opening the case
- Special feature: Latchbolt can be withdrawn by an extra key turn
- Deadbolt: Brass head, Steel latch
- Forend: SS



Rebated Forend Kit

S717R

- Suits: S717 3 lever mortice lock
- Finishes: PB, CP



5 Lever Security Mortice Deadlock

S791/2.5"
S791/3"

- Backsets: 45 & 58mm
- Bolt throw 16mm with one key turn
- 1000 key differs
- Antipick cartridge
- SS forend & striker plate



Euro Profile Security Mortice Deadlock

S731/2.5"
S731/3"

- Backsets: 45 and 58mm
- Bolt throws 16mm with one key turn
- Cylinders sold separately, refer page 30
- Brass or SS forend & striker plate



Euro Cylinder Roller Bolt Mortice Lock

S726/46
S726/51

- Backset: 40mm 85mm spindle or cylinder separation
- Forend: SS



Rebated Forend Kit

S726R

- Suits: S726, S785, 200N, 741 & SL36E euro cylinder mortice locks
- Finish: SS



Mortice Latch or Deadbolt Rebated Forend Kit

MLR1

- Suits: Houston, Denver, Newton, Oakland, Quest, Richmond, Seattle, Vita, MLS latches EDB1, EDB2, EDB5, EDB6 & S201
- Finish: SCP



Mortice Latch

ML7

- 70mm backset
- 7.6mm square follower
- Produced in high strength nylon
- Finishes: Brown, White



Mortice Latch

MLS

- 60 or 70mm backsets
- 7.6mm or 8mm square follower
- Finishes: AB (70mm only), PB, SNP



Privacy Bolt

PB

- 60 or 70mm adjustable backsets
- Produced in high strength nylon
- Knob Finishes: GP, Pine, Rimu, SCP, White, SNP



Roller Bolt

RB601

- Externally adjustable roller ball
- Finishes: CP, PB, SCP



Tubular Latch

EC606.SS

- Passage Latch
- Adjustable 60-70mm
- Finish: SS



Tubular Latch

EC606ET.SS

- Entrance Latch
- Adjustable 60-70mm
- Finish: SS



High Rotation Tubular Extension Latch

MLS127

- Suitable for use with Sylvan Globe knobsets
- 127mm backset
- 8mm square follower
- Finish: SS



Cylindrical Latch

EC60
EC70

- 60 or 70mm backsets
- Suits Sylvan cylindrical entrance, bathroom & passage sets
- Deadlocking latch available for entrance set
- Finishes: PB, SS



Extension Latch

EC90
EC127

- 90 or 127mm backsets
- Suits Sylvan cylindrical entrance sets
- Finishes: 90mm CP 127mm PB, SS



Bathroom Bolt

I-BATH 2
I-BATH 70

- 60 or 70mm backsets
- 6mm square follower
- Use with Sylvan privacy turns on page 20
- Forend finish: BSS



Magnetic Latch

MLSM

- 60mm backset
- Tools available
- Adjustable striker
- Smooth latch operation
- Privacy option available MLSMBK
- Finish: SS



Stainless Steel Extended Strike Plate

STRIKE785

- Overall: 50mm width
- Suitable for use with Sylvan S785 euro mortice lock
- Strike plates are handed
- Finish: SS



Striker Plate

STRIKE735

- Overall: 60mm
- Height: 176mm
- For use with: 735 and 795 locks
- Finish: SS



Striker Plate

ECSTRIKE

- Overall: 45mm
- Height: 57mm
- Finishes: SS, PB



Striker Plate

ecstriket

- Overall: 39mm
- Finish: SS



Striker Plate

STRIKER52

- Overall: 50mm
- Height: 57mm
- Finish: SS



Striker Plate

STRIKERT46

- Overall: 46mm
- Height 70mm
- Finish: SS



Spindles

- All spindles are 7.6 x 7.6mm
- SPLS135, SPLSM steel material
- SPL,SPW Plastic material



SPLS135

SPLSM

SPL

SPW

Mortice Lock Kit for French Doors

S785FDKIT

- Kit includes
- S785 Euro cylinder mortice 45mm lock
- S726R Rebate kit
- Euro Cylinder and turn 5 pin 68mm



STANDL. Hands-free foot-operated door opener

DO.SS

- Durable Design
- Hands-Free Operation
- Fasteners Included
- Easy Installation
- Matte Stainless Steel





Euro Profile Single Cylinder & Thumb Turn

S725TT

- Available in 5 or 6 pin cylinders
- 5 pin, 60mm or 68mm overall length
- 6 pin, 70mm overall length
- Finishes: SNP, PB, CP, Black, Graphite



Euro Profile Double Cylinder

S725DBL

- Available in 5 or 6 pin cylinders
- 5 pin, 60mm or 68mm overall length
- 6 pin, 70mm overall length
- Finishes: SNP



Euro Profile Cylinder Bathroom Turn & Emergency Release

S725BKTT

- 70mm overall length
- Finishes: SNP



Euro Profile Half Cylinder

S725/45

- 6 pin, 45mm overall length
- Finishes: SNP



Euro Profile Half Cylinder & Turn

S725TT/40
S725TT/45

- 40mm or 45mm overall length
- Finishes: SNP



DS20

- 25.4mm high
- Floor mounted
- Finish: SCP



DS6

- 26.3mm high
- Floor mounted
- Finishes: CP, SCP



DS9A

- DS9A 70mm high
- Floor mounted
- Finish: SA



DS25

- 38mm high
- Floor mounted
- Finish: SNP



DS26

- 40mm high
- Floor mounted
- Finish: SNP



DS30

- 70mm high
- Floor mounted
- Finish: SNP



DS33

- 40mm high
- Floor mounted
- Secured by Dynabolt
- Finish: SNP, Black



DS34

- 60mm high
- Floor mounted
- Secured by Dynabolt
- Finish: SNP



DS38

- 38mm (w) x 40mm (h), 50mm Rubber
- Floor mounted
- Secured by Dynabolt
- Finish: SNP, Black





DS22

- 76mm high
- Floor mounted
- Suitable for external use
- Finish: 304 Grade SS



DS7

- 76.6mm length
- Wall mounted
- Socket hold-back
- Finishes: CP, PB, SCP



DS3

- 92.5mm length including magnet
- Wall mounted
- Magnetic hold-back
- Finishes: CP, PB, SCP



DS27

- 84mm length
- Wall mounted
- Finish: SNP, Black, Graphite, Brushed Brass
- Trade 10 Pack available



10
PACK



DS14

- 75mm length
- Wall mounted
- Finish: 304 Grade SS



DS29

- 110mm length
- Wall mounted
- Finish: SS



DS4

- 75.5mm length
- Wall or Floor mounted
- Magnetic hold-back
- Finishes: CP, PB, SCP



DS32

- 75mm length
- Wall or Floor mounted
- Magnetic hold-back
- Finishes: SS



DS37

- 75mm length
- Wall or Floor mounted
- Magnetic hold-back
- Finishes: SS



DS24

- 77mm length
- Wall mounted
- Finish: SNP
- Trade 10 Pack available



10
PACK



DS31

- 85mm high
- Wall mounted
- Finish: SS



DS19

- 52.8mm high
- Packer (for use with DS17)



DS15

- 75mm length
- Wall or Floor mounted
- Square door stop (includes both rubber stopper options)
- Finish: 304 Grade SS
- Trade 10 Pack available



10
PACK



DS1

- 75mm length
- Wall mounted
- 3 screw fixing
- Finishes: CP, PB, SCP



DS28

- 108mm length
- Wall mounted
- Finish: SNP



DS16

- 98mm length including catch
- External wall mounted
- Finish: SCP



DS17

- 91.6mm high including catch
- External floor mounted
- Finish: SCP, Black



DS18

- 64mm length including catch
- External small wall mounted
- Finish: SCP





SFP2

- 65mm overall
- Finish: BSS



SFP6.L
SFP6.S

- 49.3mm or 41.2mm overall
- Finish: SNP



SFP12

- 29mm overall
- Sliding door finger pull
- Finish: SNP



SFP4

- 102mm overall
- Finish: BSS



SFP15

- 102mm overall
- Finish: BSS



SC11.100

- 110mm overall
- Finishes: SNP



SFP16

- 120mm overall
- Finish: BSS



SFP3

- 120mm overall
- Finish: BSS



SFP8

- 146mm between centres
- Finish: SNP



SFP14

- 160mm and 224mm overall
- Passage Kits available: 2x Pulls 1x End Pull SFP14.SKIT - SFP14.MKIT
- Finish: SNP, Black



SFP11

- 101mm overall
- Finish: SNP



SFP7

- 101mm between centres
- Finishes: CP, PB, SNP



SFP

- 100mm between centres
- Finishes: AB, CP, PB, SCP



SFP5.L
SFP5.S

- 46mm or 32mm overall
- Finish: SNP





For Cavity Doors Passage Set

SDPPS

- Suits door thickness 33mm to 38mm
- Finishes: CP, PB, SS



For Cavity Doors Bathroom Set

SDPBK

- Suits door thickness 33mm to 38mm
- Finishes: PB, SS



Cavity Slider

C3

- Entrance, Privacy & Passage functions
- Suitable for 35-45mm door thickness
- 50mm backset
- Solid diecast construction
- Includes door edge finger pull
- Adjustable striker plate
- Integrated emergency release (privacy)
- 3 Keys included (entrance)
- Includes fixing instructions
- Finishes: Black, Satin Nickel, Satin Brass & Graphite



Cavity Slider Set

C1

- 54mm hole required
- Passage and Privacy options available
- Flush design for total door retraction
- Suits door thickness 32mm to 42mm
- 60mm backset
- Finish: 304 grade stainless steel, Black



Cavity Slider Set

C2

- 54mm hole required
- Passage and Privacy options available
- Flush design for total door retraction
- Suits door thickness 32mm to 42mm
- 60mm backset
- Finish: 304 grade stainless steel



UF4

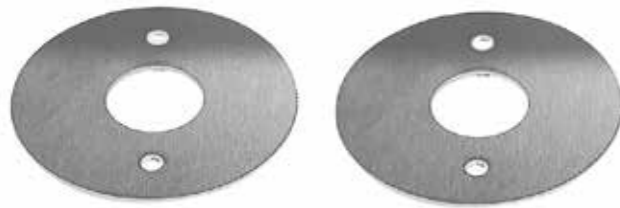

UF5



Adapter plate to cover 54mm hole

- For use with Sylvan Centro
- Round: 65mm diameter, 2 holes at 42mm B/C
- Square: 65mm square
- Sold in pairs
- Not suitable for use with Centro Privacy option
- Finish: SS



UF5 installed on Centro Andora lever handle



Through-bolt fixing kit

UF54

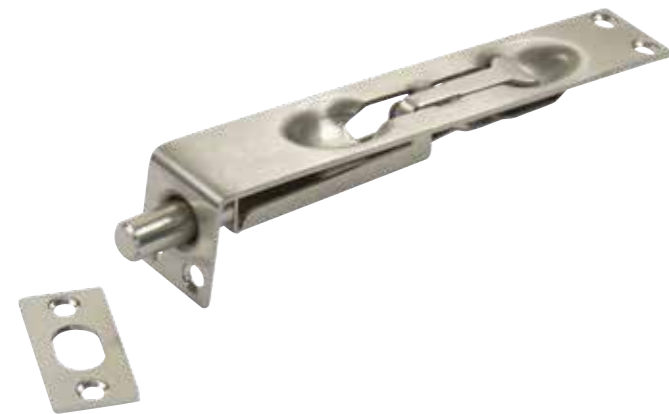
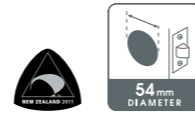

Bolt.SS

BOLT.SS

- 304 Grade Stainless Steel
- Bolt throw 15mm
- Width 25mm
- Length 150mm
- Finishes: SS, PB

Door Guard

DG1

- Height adjustable packers
- Rubberised arm for smooth operation
- Ergonomically designed
- Designed for New Zealand requirements
- Finish: SNP



Adjustable strength 23mm magnetic catch

MC1

- Can be used anywhere a roller catch would normally be fitted
- No latch noise when opening door
- Completely concealed when door closed
- Easy fit stainless steel housing cup makes installation quick and tidy
- Power adjustment packers supplied
- Note: 25mm Forstner bit available if required MCFB25



Adjustable strength 23mm magnetic catch

MC2

- Can be used anywhere a roller catch would normally be fitted
- No latch noise when opening door
- Completely concealed when door closed
- Note: 25mm Forstner bit available if required



Mini 12mm concealed magnetic catch

MC4

- Ideal for use on cabinets
- Easy fit housing cups
- Self adhesive stainless steel cover plates
- Drill in rubber buffers
- Suitable for use on door thicknesses of 16mm to 30mm



Extra heavy duty concealed magnetic catch

MC3

- Suitable for use on doors that require secure closing without latching
- Includes stainless steel power adjustment packers
- Easy fit housing cups
- Self adhesive stainless steel cover plates
- Drill in rubber buffers
- Note: additional packers are available MC3Pack



Magnetic Catch with free forstner bit - 8 pack

MC5

- Can be used anywhere a roller catch would normally be fitted
- No latch noise when opening door
- Completely concealed when door closed



Forstner Bit

MCFB25

- 25mm forstner bit for use with the Sylvan magnetic catch. MC1



Strike plate adjusting screw driver

Magnetic Latch Centering Tool



Wall Mounted Banister Bracket

BB1

- Designed: In New Zealand for New Zealand homes
- Construction: Sturdy zinc die-cast construction, independently load tested by SGS materials testing
- Compliance: With NZ building code, access routed D1/AS1
- Finish: SCP



Wall Mounted Banister Bracket

BB3

- Designed: In New Zealand for New Zealand homes
- Construction: Sturdy zinc die-cast construction, independently load tested by SGS materials testing
- Compliance: With NZ building code, access routed D1/AS1
- Finish: CP, SCP, Black, SNP



Wall Mounted Banister Bracket

BB5

- Designed: In New Zealand for New Zealand homes
- Construction: 316 Grade Stainless Steel
- Finish: Pol.SS



Wall Mounted LED Ready Banister Bracket

BB8.SS

- Suitable for use with low voltage led wiring (not included)
- Designed to accept cabling so hand rail can be back lit
- Designed in New Zealand for New Zealand homes
- Suitable for round profile handle rail section, exterior and interior use
- Produced in 316 Grade Stainless Steel
- Brushed Stainless Steel finish



Upright Banister Bracket

BB6

- Designed: In New Zealand for New Zealand homes
- Construction: 316 Grade Stainless Steel
- Finish: Pol.SS



Upright Banister Bracket

BB2

- Designed: In New Zealand for New Zealand homes
- Construction: Sturdy zinc die-cast construction, independently load tested by SGS materials testing
- Compliance: With NZ building code, access routed D1/AS1
- Finish: SCP



Upright Banister Bracket

BB4

- Designed: In New Zealand for New Zealand homes
- Construction: Sturdy zinc die-cast construction, independently load tested by SGS materials testing
- Compliance: With NZ building code, access routed D1/AS1
- Finish: CP, SCP, SNP





panic exit devices

ISEO Push Panic Exit 

- Made in Italy
- Modular, reversible
- Lateral locking
- Steel latch with self-locking function
- Suitable for fire doors
- Pre-assembled top/bottom rods
- Caps for top/bottom holes
- Nylon spacer for external control
- Latch keepers included

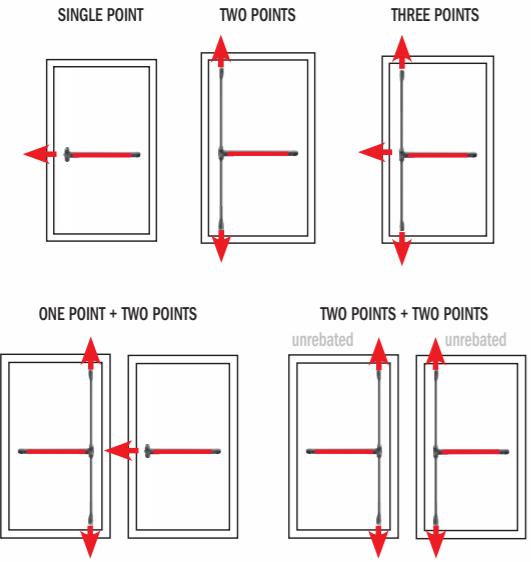
MADE IN EUROPE



ISEO Base Panic Exit 

- Made in Italy
- Modular, reversible
- Lateral locking
- Steel latch with self-locking function
- Suitable for fire doors
- Pre-assembled top/bottom rods
- Caps for top/bottom holes
- Nylon spacer for external control
- Latch keepers included

MADE IN EUROPE

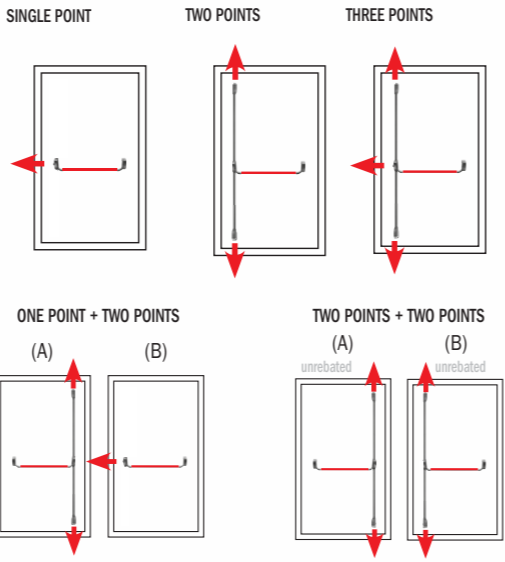

smart cylinders



Libra Smart Oval Cylinder

82K390VAL

- Stand alone electronic oval cylinder
- Fits Oval profile cylinder locks
- No wiring required
- 3 year manufacturer's warranty
- Battery life 1 year
- Passage function friendly
- Able to communicate with smart phone, RFID cards and electronic key tags
- Range of communication between phone and cylinder: 10 metres
- Suitable for exterior doors IP66 rated
- Stores up to 300 users
- Able to communicate with most iPhone and Samsung smart phones
- Free app available (ISEO ARGO)

Libra Smart Euro Cylinder

82K

- Stand alone electronic euro cylinder
- Fits European profile cylinder locks
- No wiring required
- 3 year manufacturer's warranty
- Battery life 1 year
- Passage function friendly
- Able to communicate with smart phone, RFID cards, electronic key tags
- Range of communication between phone and cylinder 10 metres
- Suitable for exterior doors IP66 rated
- Stores up to 300 users
- Cylinder body lengths available are 70, 80 and 90mm
- Able to communicate with most iPhone and Samsung smart phones
- Free app available (ISEO ARGO)
- Available with black reader and Satin Nickel turn

3 point locking



Performa Lock – Wooden Doors 723

Performa Lock – Aluminium Doors 7235

- Face plate length 2300mm but can be cut to length
- Minimum length 1700mm
- Three strike plates included with the lock
- Tested to over 200,000 opening/closing cycles under load
- 85mm cylinder spacing
- Deadbolts operated by cylinder
- Easy locking – gearing within main lock provide easy operation
- Low friction chamfered deadbolts help maintain weather seal compression for better thermal insulation and energy saving
- Can be operated by double turn kit rather than lever furniture
- Flat faceplate versions suitable for timber doors (30, 40, 50 and 60mm backset)
- U channel faceplate versions suitable for aluminium doors (30, 40, 50 and 60mm backset)



MADE IN EUROPE

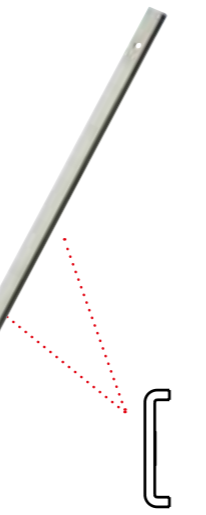

Images show "U" faceplate

Performa Lock for Wooden Doors

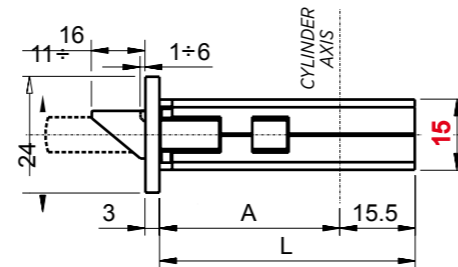

Lock flat faceplate 24 X 3

Backset	A	L
30	27	42,5
40	37	52,5
50	47	62,5
60	57	73

Performa lock for Aluminium doors

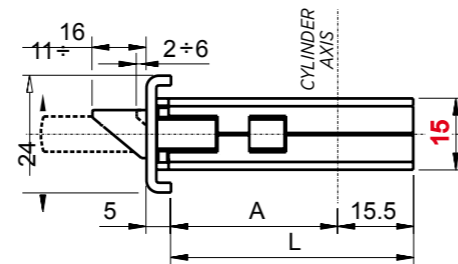

Lock "U" faceplate 24 X 5

Backset	A	L
30	24	39,5
40	34	49,5
60	54	70

mortice locks

MADE IN EUROPE



Iseo Open Case Mortice Lock Suitable for Aluminium Frames

741

- Reversible latch
- Available in 20, 25, 30, 35mm backsets
- 85mm cylinder spacing
- Operated with optional euro profile cylinder
- Front plate 238 x 22 x 3mm
- Deadbolt has a 15mm throw
- Stainless Steel faceplate
- Includes strike plate



Iseo Swing Bolt Mortice Lock for Aluminium Doors

781

- Rotating/drop deadbolt with a 24mm throw
- Available in 25, 30, 35mm backsets
- Reversible and adjustable latch bolt 10 to 15mm
- 85mm euro cylinder spacing
- Front plate 290 x 24 x 3mm
- Stainless Steel faceplate
- Strike plate sold separately, item code 781Strike



Iseo Parrot Beak Mortice Lock for Sliding Doors

7814

- Available in 30, 35mm backsets
- Hook deadbolt has 8mm clearance with a 18mm throw
- Front plate 290 x 24 x 3mm
- Stainless Steel faceplate
- Strike plate sold separately, item code 7814Strike



Iseo Parrot Beak Mortice Lock for Sliding Doors

78147

- Available in 35mm backset
- Hook deadbolt has 14mm clearance with a 24mm throw
- Front plate 290 x 24 x 3mm
- Stainless Steel faceplate
- Strike plate sold separately, item code 7814Strike



Mortice Latch

749

- Available in 30mm backset
- Reversible latch
- 85mm cylinder spacing
- Front plate 238 x 22 x 3mm
- Stainless Steel faceplate
- For use on doors requiring passage mode
- Can be used for patio function and for use on doors requiring auto latching ie, pool areas
- Strike plate sold separately, item code 781Strike



Roller Catch

7640

- Adjustable protrusion of roller catch
- Heavily sprung
- Strike plate included
- Finish: NP



Iseo closed case mortice lock suitable for aluminium and wooden frames

200N

- Reversible latch
- Available in 40 mm backset
- 85mm cylinder spacing
- Operated with optional euro profile cylinder
- Front plate 238 x 22 x 2.7 mm
- Double throw deadbolt -20mm throw
- Includes striker plate
- Stainless steel finish

striker plates



Striker plate for the 723 Performa divator

723DSTRIKE

- Height: 132mm
- Width: 24mm
- Finish: SS
- Iseo ref: 38220



Striker Plate for 7814 Parrot Beak lock

7814STRIKE

- Height: 132mm
- Width: 22mm
- Finish: SS
- Iseo ref: 38021



Striker Plate for Perfoma lock

723STRIKE

- Height: 180mm
- Width: 24mm
- Finish: SS
- Iseo ref: 38230



Striker plate for 781 Swing bolt

781STRIKE

- Height: 180mm
- Width: 24mm
- Finish: SS
- Iseo ref: 38030



Strike plate for Performa roller kit

33092

- Height: 179mm
- Width: 20mm
- Finish: SCP
- Iseo ref 33092



Strike plate for 741 lock

741STRIKE.SS

- This item is included with the lock
- Reversible
- Finish: SS



Armoured Lock

678

- Cylinders not included
- Latch reversible
- 30mm bolt throw
- 63mm Backset
- Adjustable Rod Length - 455-675mm
- Optional deadbolts available to make three point locking

MADE IN EUROPE



Image shows right hand

Iseo Stainless Steel Electric Gate Lock

52031 R / 52032 L

- Suitable for exterior gates
- Backset 60mm
- Lock body produced in 304 grade Stainless Steel
- Optional Stainless Steel mounting plate also available
- Left and right options available not reversible
- Self locking latch bolt
- Inside red button can be deactivated by inside cylinder for use on an open gate
- Replacement solenoids available
- 12 volt AC, 15 wattsv



Mid Rail Lock 704

704

- 80mm backset to oval cylinder
- Suitable for aluminium doors with mid rail
- Operated by oval cylinder
- Deadbolt with 9mm throw with built-in latchbolt
- Alternative to knobset being fitted at 127mm

MADE IN EUROPE



Mid Rail Lock and Handle Set

704HANDLE

- 304 grade stainless Lagos lever handle
- Iseo Mid Rail 80mm lock
- Mini oval 5 pin double cylinder - 54.6mm length
- Stainless steel back plate

cylinders & escutcheons



F5 5 pin Euro Cylinder and Turn

8289

- 70.6mm cylinder length
- F5 key blanks available
- Finish: NP

MADE IN EUROPE



F6 6 pin Euro Cylinder and Turn

8189

- 70.7mm cylinder length
- F6 key blanks available
- Finish: NP

MADE IN EUROPE



F5 Euro Double Cylinder

8209

- 70.6mm cylinder length
- Key alike available
- F5 key blanks available
- Finish: NP



F6 Euro Double Cylinder

8199

- 70.7mm cylinder length
- Key alike available
- F6 key blanks available (21059)
- Finish: NP



Mini 5 pin Oval Cylinder and turn

8350

- 54.6mm cylinder length
- Suits ISEO 704 mid rail lock
- Key blanks available
- Finish: NP, PB



Mini 5 Pin Oval Double Cylinder

8300

- 54.6mm cylinder length
- Suits ISEO 704 mid rail lock
- Key blanks available (20159)
- Finish: NP, PB



ISEO Escutcheon

4202

- Euro escutcheon
- Finish: Anodised Aluminium



ISEO Escutcheon

4203

- Euro escutcheon
- Finish: SS



Hydraulic Door Closer, standard arm

IS110

- Hydraulic door closer, can be fitted to all types of doors, up to 100kg in weight and 1100mm in width
- Adjustment: closing speed, latching action or silent closing, back check
- RV force: EN 2-4
- Finish: Silver, Black

● ●



Hydraulic Door Closer, slide track

IS65

- Hydraulic door closer, can be fitted to all types of doors, up to 950 mm in width
- Quiet closing action
- RV force EN 3
- Finish: Silver, Black

● ●



Hydraulic Door Closer

IS115

- Can be fitted to all types of doors, up to 100kg in weight and 1000mm in width.
- For internal doors and doors opening outwards
- For single action doors
- Force EN 2 - 4
- 2 year warranty
- Finish: Silver, Black

● ●



Hydraulic Door Closer

IS315

- Can be fitted to all types of doors, up to 160kg in weight and 1400mm in width.
- For internal doors and doors opening outwards
- For single action doors
- Force EN 3 - 5
- 2 year warranty
- Finish: Silver, Black

● ●



ISE9100 Automatic Swing Door Operator

IS9100

- Ideal for use in the Medical or Aged care sectors.
- Suitable for use on doors up to 120kg in weight and 700mm in wide. - with an upgrade card available to increase the capacity to 160kg in weight and 1100mm in width
- For single action doors
- RV Force EN 2 - 4
- 2 year warranty
- Finish: Silver

●



door handing

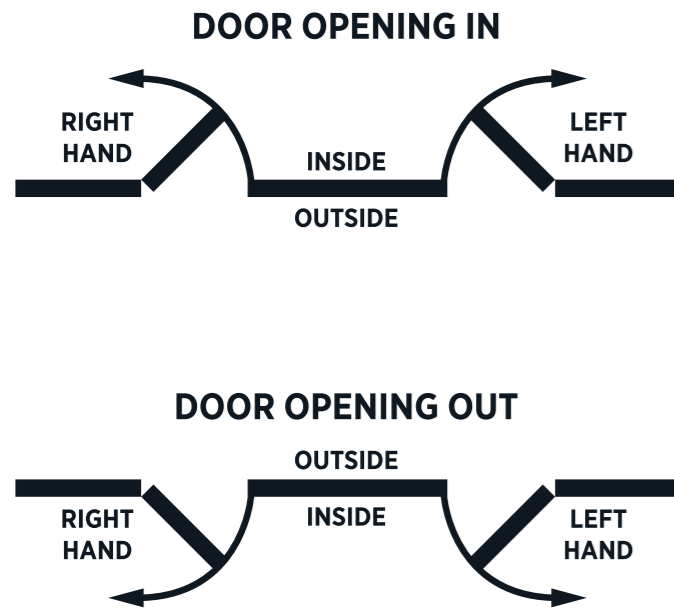

leverset functions

ET Entrance Lock

Latch bolt operated by key from outside, by lever inside. Inside handle always active. Deadlocking latch bolt.

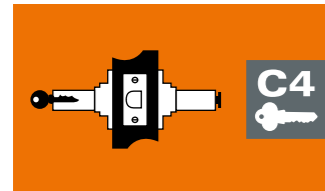

BK Bathroom Lock

For bedroom, bathroom or toilet. Inside push button locks outer lever. Coin operated emergency release.

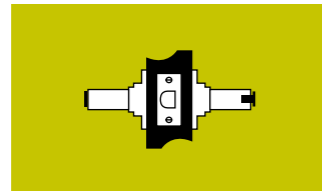

PS Passage Latch

For interior doors not requiring locking. Levers are always active.

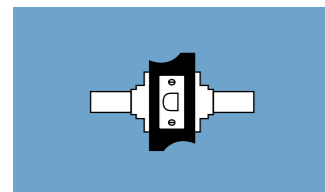

DT Dummy Trim

Fixed lever for wardrobe and cupboard doors. Use with roller bolt, magnetic catch or similar.

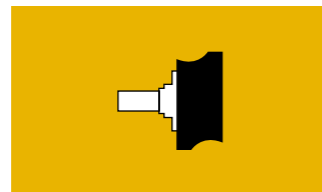

CARING FOR THE FINISH OF YOUR HANDLES:

- The plated finishes of polished brass, gold, black, black nickel plate, are all classified as soft finishes.
- It is essential that no cleaning products are sprayed onto items that have a black finish as cleaning products will damage the finish.
- Polished Brass and Stainless steel products do require a little bit of TLC from the homeowner, to ensure the finish remains in it's purchased condition. Sea salt, dust, oil from hands and environmental conditions can cause specs or discolouration to the surface. It is essential that these surfaces are cleaned regularly (every 3 months) with a soft cloth and mild soapy water. Or for Stainless steel products use a stainless steel cleaner and lanolin to protect its surface.

Adapter Plates	46
Banister Brackets	48
Cavity Sliders	44-45
Lever Handles	12-29
Andora	12
Asti	14
Como	12
Lagos	17
Monza	14
Murano	14
Porto	17
Savona	12
Trento	16
Deadbolts	30
Digital Lock	4-5,9
Door Guard	46
Door Stops	39-41
Double Turns	21
Entrance Kits	10-11
Entrance Set	11
Escutcheons	18
Euro Cylinders	38
Flush Bolt	46
Flush Pulls	42-43
French Door Kit	37
Knobsets	31-32
Amos	32
Globe	32
Quest	31
Vita	31
Knobs	33
Wooden, Metal	33
Latches, Bolts	36
Lever Handles for Aluminium Doors	27
Leo	27
Orion	27
Virgo	27
Lever Handle Sets	22-26
Beaumont	22
Denver	24
Houston	26
Newton	23
Oakland	23
Richmond	25
Rockford	22
Seattle	25
Magnetic Catch	47
Mortice Locks Sylvan	34-36
Privacy Bolts	36
Privacy Turns	20-21
Pull Handles	6-7
Push and Pull Plates	9
Rebate Kits	35
Signs	4-5
Smart Locks	4-5
Spindles	37
Striker Plates	37
Superior Hardware	
Tapered	28
Linear	28
ISEO Cylinders	56
ISEO Door Closers	57
ISEO Gate Lock	55
ISEO Libra Smart	51
ISEO Mid Rail Lock	55
ISEO Mortice Locks	53
ISEO Panic Hardware	50
ISEO 3 Point Locking	52

ALIKE Keyed Alike
This product is available with a keyed alike option

C4 C4 Keyway
This keys supplied with this product are C4

COMBO Combination Set Option
This product can be purchased in a pack with an Entrance Set and double cylinder deadbolt keyed alike

Builder's Pack
This product can be purchased in cardboard box packs enabling access for trade application

ONLY Builders Pack Only
This product can only be purchased in cardboard box packs (not available in blister pack)

NEW ZEALAND Buy NZ Made
This product has been produced in New Zealand

316 316 Stainless Steel
This product has been produced in 316 Stainless Steel and is suitable for marine or high salt areas

Fire Rated
This product has a fire rating as standard to specific doors, please refer to door manufacturer for more information.

10 ↔ 30mm
DIAMETER

54mm
DIAMETER

42mm B/C
20mm DIA

Spindle Diameter

- This product is able to be used in existing spindle holes from 10 to 30mm in diameter.

Spindle Diameter

- This product is able to be used in 54mm diameter hole.

Spindle Diameter

- This product is able to be used in 20mm diameter hole.

WARRANTY*	WARRANTY*	WARRANTY*	WARRANTY*	WARRANTY*
7 YEARS MECHANICAL	3 YEARS FINISH	10 YEARS MECHANICAL	5 YEARS FINISH	10 YEARS MECHANICAL
10 YEARS MECHANICAL	7.5 YEARS FINISH	10 YEARS MECHANICAL	10 YEARS FINISH	15 YEARS MECHANICAL
10 YEARS MECHANICAL	10 YEARS FINISH	15 YEARS MECHANICAL	10 YEARS FINISH	

Warranty

- Subject to conditions and exclusions. See www.sylvan.co.nz for full warranty details.

Special Finishes

- *2 Year Finish Warranty applies to Black products for normal use, excludes scratching or damage from cleaning products.

AB Antique Brass

B Black

BSS Brushed Stainless Steel

CP Chrome Plate

G Graphite

GP Gold Plate

PB Polished Brass

PSS Polished Stainless Steel

SA Satin Aluminium

SCP Satin Chrome Plate

SNP Satin Nickel Plate

SS Satin Stainless Steel



sylvan[®]

GDRutter
Limited



Head Office:
Box 100183, North Shore City,
Auckland 0745,
New Zealand

Physical Address:
127 Diana Drive,
Glenfield,
Auckland 0627,
New Zealand

Ph: +64 9 444 5359
FreeFax: 0800 479 5826
Email: sales@gdrutter.co.nz
FreePhone: 0800 279 582



www.sylvan.co.nz

