

SYNERGY

BATHROOM ACCESSORIES



ALEXANDER



SYNERGY



Toilet Brush Holder
Dérouleur-Papier



Single Towel Rail
Porte Serviette

400mm - 16"
600mm - 24"
760mm - 30"



Double Towel Rail
Porte Serviette Double

600mm - 24"



Glass Shelf
Etagère en Verre



Toilet Roll Holder
Dérouleur-Papier



Covered Toilet Roll Holder
Dérouleur-Papier avec
Couvercle



Robe Hook
Porte - Habits



Towel Ring
Anneau Porte



Tumbler Holder
Porte-Verre



Soap Dish
Porte Savon avec Cuvette



In fashion, coordination is a key element. The Synergy Shower slides have been created as a complementary match to the accessories.

Following the established theme the Synergy slide bar and adjustable locking unit are made from solid brass with a chrome finish for durability.

The shower head options include the unique hexagonal head, single and multi-function sprays and the minimalistic styling of the microwand.

The 1.5 meter long hose allows for versatility of movement, and its stainless steel construction ensures longevity. The brass water connector completes each one of these sets to create the final element that is Synergy.



Sliding Shower Set
Ensemble Douche Avec
Curseur

1 FUNCTION
suitable for all pressures



Sliding Shower Set
Ensemble Douche Avec
Curseur

3 FUNCTION
suitable for mains pressure



Micro Wand Sliding
Shower Set
Ensemble Douche Avec
Curseur

1 FUNCTION
suitable for all pressures

SYNERGY SHOWER SLIDES

PRODUCT SPECIFICATIONS

MATERIALS: Slide - Brass Hose - Stainless Steel 304

FINISH: Chrome

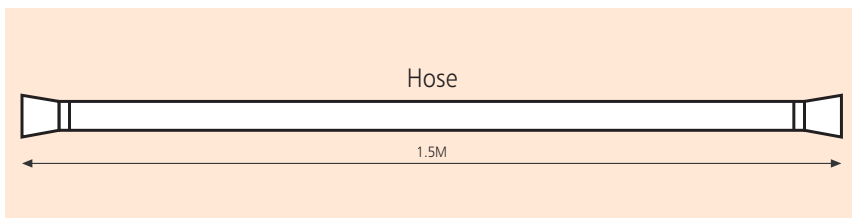
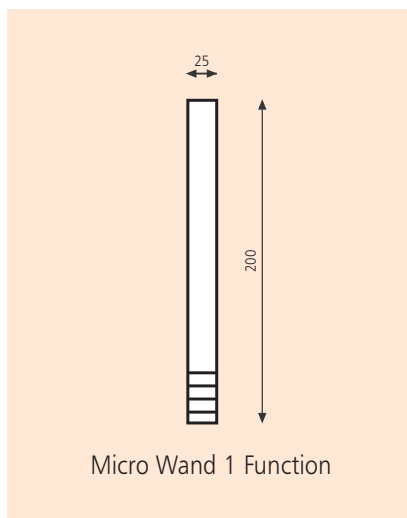
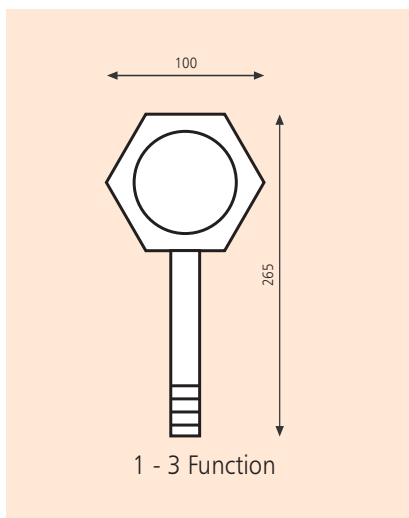
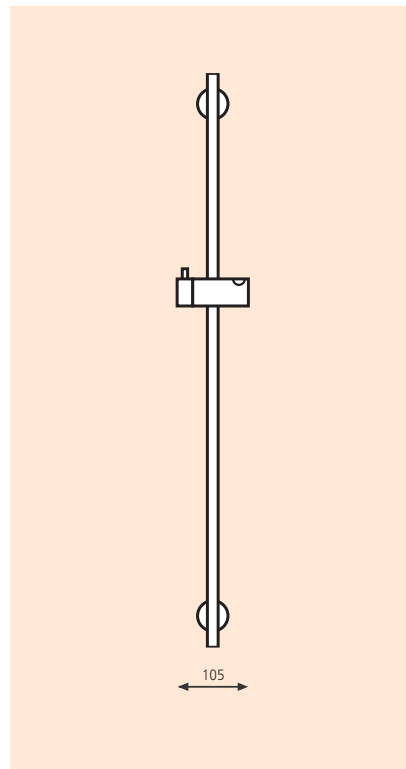
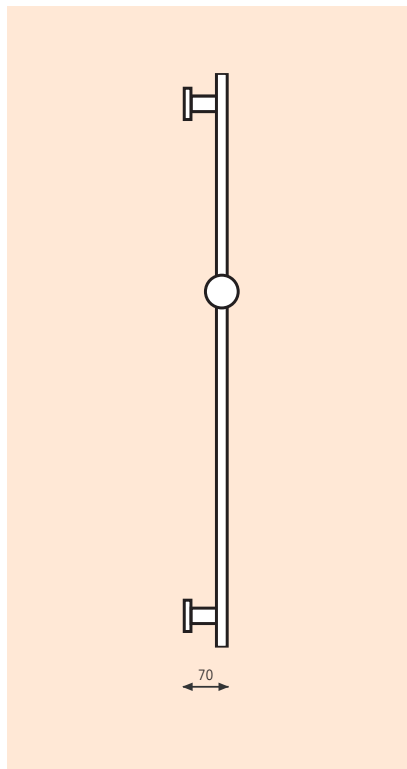
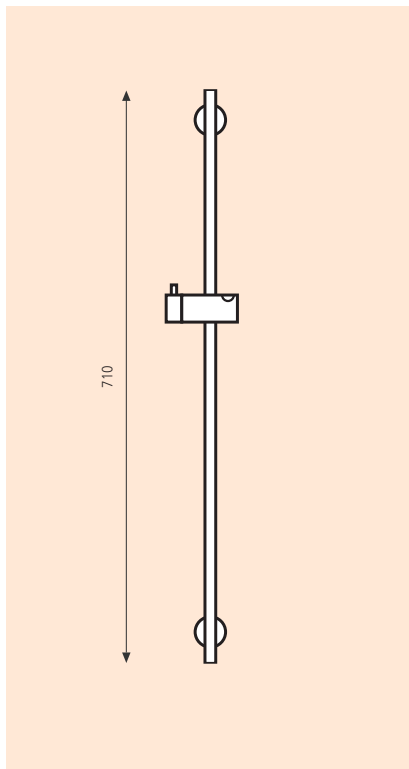

SYNERGY 1 FUNCTION

CODE: SHO-9A05
SUITABLE FOR ALL PRESSURES

SYNERGY 3 FUNCTION

CODE: SHO-9B05
SUITABLE FOR MAINS PRESSURE

SYNERGY MICRO WAND

CODE: SHO 9C05
SUITABLE FOR ALL PRESSURES

1 FUNCTION



SUITABLE FOR ALL PRESSURES

3 FUNCTION



SUITABLE FOR MAINS PRESSURE

ALEXANDER MFG RESERVE RIGHT TO ALTER SPECIFICATION WITHOUT NOTICE

ALEXANDER

ALEXANDER MFG LTD

PO Box 32 009, Christchurch, New Zealand

Telephone 64-3-373 8010 Fax 64-3-381-2648

alexander.mfg@xtra.co.nz

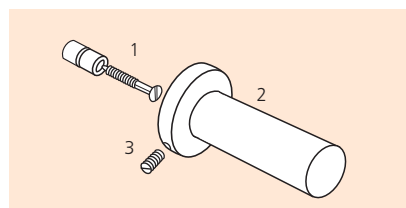

- 1 Screw brass pedestal to wall
- 2 Slide shower set rail over pedestal
- 3 Tighten Allen screw on flat

SYNERGY

PRODUCT SPECIFICATIONS

MATERIAL: Brass FINISH: Chrome

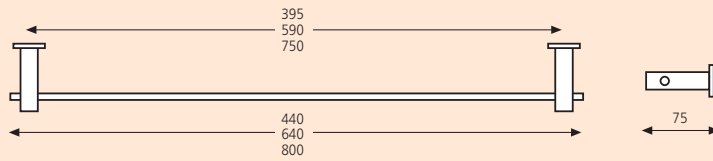

Single Towel Rail 400mm Code: SYN-9C05
 600mm Code: SYN-9A05
 760mm Code: SYN-9D05

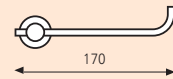

Toilet Roll Holder
 Code: SYN-9E05

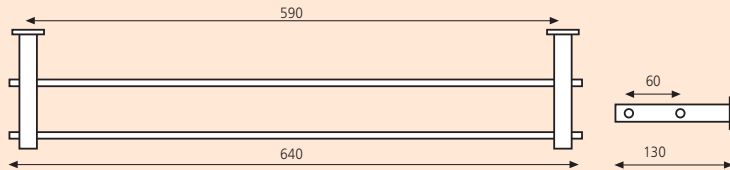

Double Towel Rail 600mm Code: SYN-9B05



Robe Hook
 Code: SYN-9H05

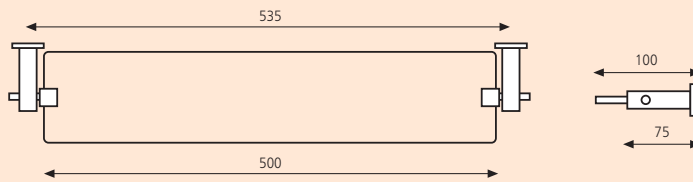

Glass Shelf Code: SYN-9J05

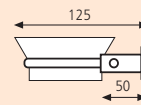
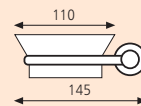

Soap Dish
 Code: SYN-9G05

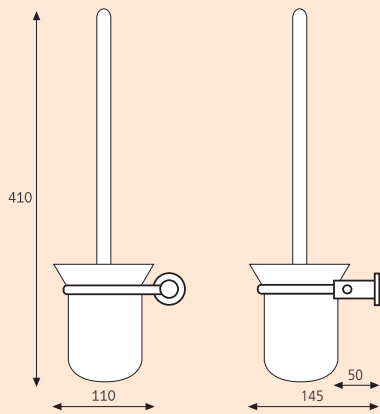

Toilet Brush Holder
 Code: SYN-9U05

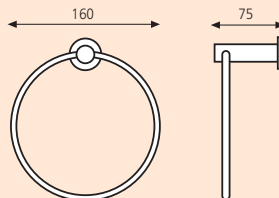

Towel Ring
 Code: SYN-9K05

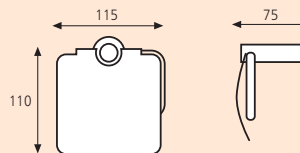

Towel Ring
 Code: SYN-9S05

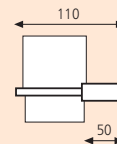
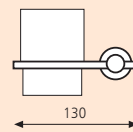

Tumbler Holder
 Code: SYN-9F05

ALEXANDER MFG RESERVE RIGHT TO ALTER SPECIFICATION WITHOUT NOTICE

ALEXANDER

ALEXANDER MFG LTD

PO Box 32 009, Christchurch, New Zealand

Telephone 64-3-373 8010 Fax 64-3-381-2648

alexander.mfg@xtra.co.nz

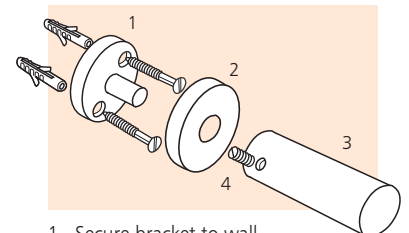

- 1 Secure bracket to wall
- 2 Place cover over bracket
- 3 Fit body on bracket
- 4 Tighten Allen screw on flat