

# Windsor

ARCHITECTURAL HARDWARE

It's the finer details that  
make a home

Make yours with the  
Windsor touch

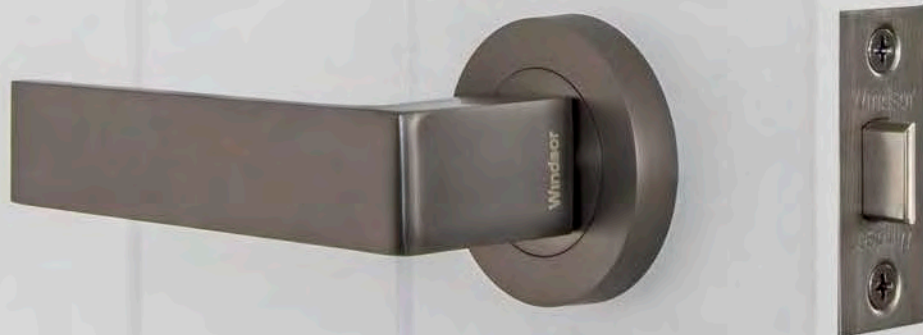

No. 21A

Product  
Catalogue

[windsorbrass.co.nz](http://windsorbrass.co.nz)

# Hand finished in New Zealand

Developed especially for the Windsor Superior Solid Brass Range of products, our Pull Handles, Levers, Plates, Roses and Accessories are extruded, forged or machined from the finest quality solid brass. At our NZ factory, a variety of techniques are applied to achieve lustre, patina, tone and texture.

The Living Finishes collection will add a natural luxurious feel to your interior accents. Designed to transform beautifully over time, brass hardware is the perfect choice when considering style and durability ideal for the NZ climate.

Where a lacquer is required we offer Matt Lacquered for a specific low-sheen look, or the traditional Gloss Lacquered with a classic selection of finishes.

Powder Coat options are available on most products for a true customized colour theme.

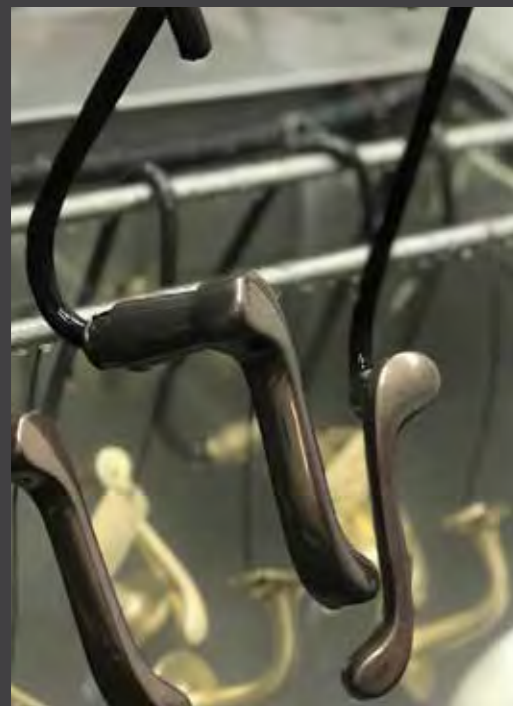

## Standard Stock Finishes

Some finishes only available to certain products

### 1-2 Day Ordering Leadtime

1-2 days delivery time applies to standard stocked products. In the unlikely event of delays or out of stocks, extended leadtimes will occur.

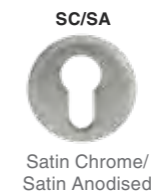
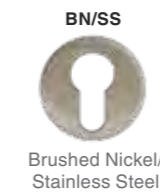

## New Stock Finishes

Only available to certain products

### 1-2 Day Ordering Leadtime

1-2 days delivery time applies to standard stocked products. In the unlikely event of delays or out of stocks, extended leadtimes will occur.

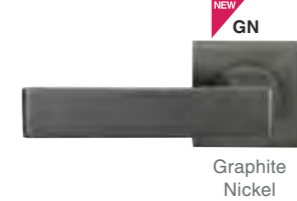
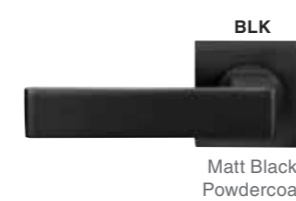

## Special Finishes

Brass Base



### 14 Day Ordering Leadtime

14 days delivery time applies to non-stocked bronze products and made to order pull/bar handles. Products and finishes in this category are non-returnable items. In the unlikely event of delays, extended leadtimes will occur.

- > Use UB where RLB is not available.
- > When using AB, some accessories are Bronze PC to match.
- > Use PVD or TG to match PB where PB is not available.
- > Please refer to the specific product page for AB, PB, RLB and UB leadtimes. Some items have 1-2 days delivery time.

### Living Finishes



### Gloss Lacquered

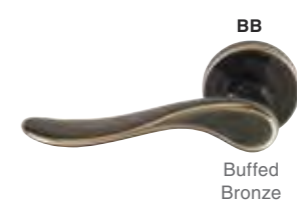

### Matt Lacquered



## Special Finish

Any Base Metal

### 14 Day Ordering

14 days delivery time applies to non-stocked powdercoated products. Products and finishes in this category are non-returnable items. In the unlikely event of delays, extended leadtimes will occur.



- > Products, specifications, finishes and leadtimes are subject to change without notice
- > Special finishes on products may vary from colour swatches shown
- > A minimum quantity or extra surcharge may apply for some finishes
- > Special order products are non-returnable
- > Please check lead times for special orders
- > Brass items can be supplied unlacquered (surcharge applies)





# Insist on style and quality Insist on **Windsor**

Windsor Brass Ltd is pleased to present in this catalogue an unparalleled selection of genuine, superior, quality door furniture and accessories specially chosen to complement the high standard of architecture found in today's homes and buildings.

These exclusive collections are processed in our spacious factory where they receive the Windsor touch – from specialty finishes to customisation. Our vast warehousing system allows us to stock the most comprehensive portfolio of door, cabinet, window and letterbox hardware available.

Established in 1984, Windsor Brass Ltd is a family-based New Zealand company with the experience and expertise essential for providing the prompt, efficient, courteous service and delivery that attracts and retains satisfied customers. Today the Windsor name has developed a strong sense of corporate identity and become renowned for its commitment to continuous improvement.

We invite you to peruse the range, make your choice and compare the difference.

## Our Range

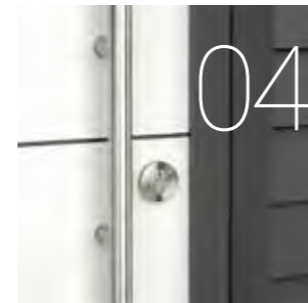

Entrance Pull Handles



Door Furniture

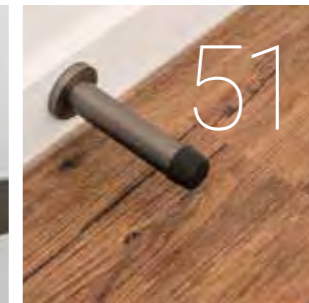

Door Accessories



Privacy & Sliding Door

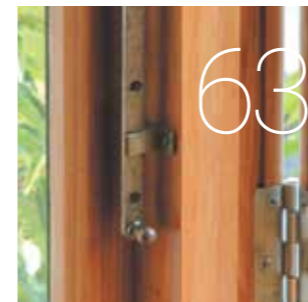

Window Fittings, Hooks & Bannister Brackets

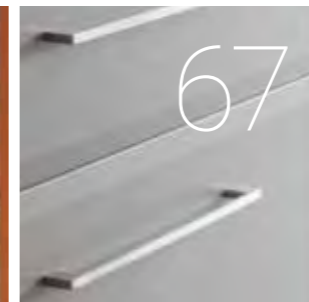

Cabinet Handles

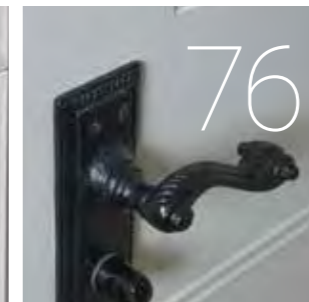

Black Iron



Door Closers

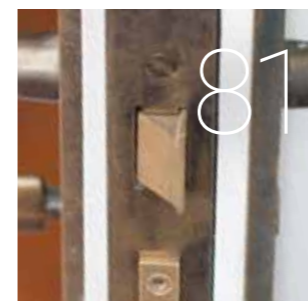

Locks, Latches & Cylinders

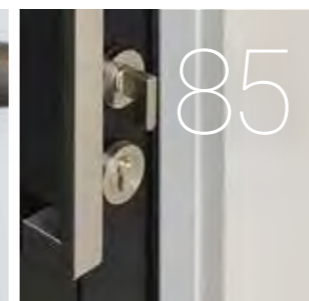

Pull Handle Entrance Lock Kits

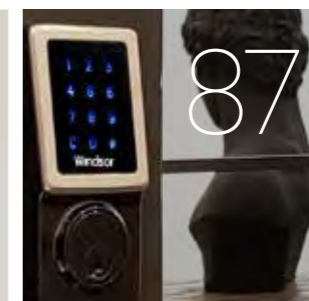

Keyless Entry & Electronic Deadbolt Locks



Care & Maintenance, Technical

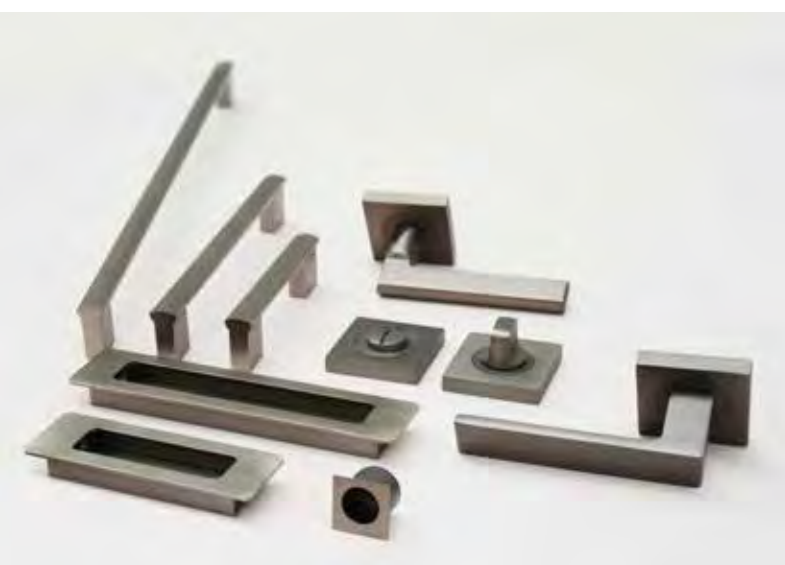

### Abbreviations

- Ø Diameter
- id Inside Diameter
- od Outside Diameter
- o/a Overall Length
- pic As Pictured
- b/s Backset
- c/s Case Size
- pj Projection
- crs Screw/Bolt Centres

# Entrance Pull Handles

## Entrance Pull Handles > 304 Grade Stainless Steel

See Page 83-91 for Lock options  
See Page 92 for Care and Maintenance



1373-SS



7099-GN



1368-BLK

### Combo Kit

Includes:

- > 1 Pair Pull Handles
- > Double Turn Lock Kit
- > Floor Mount Doorstop



### NEW Mini Lever Combo Kit

Includes:

- > 1 Pair Pull Handles
- > Mini Lever Lock Kit
- > Floor Mount Doorstop



### Snake Pull Handle

7134  
1239 Combo\*



### Torch Pull Handles

7104  
1273 Combo\*  
1368 ML Combo\*\*



7103



7069



7070



7103-SS

> All Stainless/Brass components

- 300mm crs
- 600mm o/a
- 38mm Ø bar
- 70mm pj

Finishes: ▽SS ▽PC

> All Stainless/Brass components

- 250mm crs
- 530mm o/a
- 38mm Ø bar
- 80mm pj
- 160mm crs
- 350mm o/a
- 32mm Ø bar
- 75mm pj

Finishes: ▽BLK, SS ▽PC

> All Stainless/Brass components

- 400mm crs
- 610mm o/a
- 25mm Ø bar
- 90mm pj
- 200mm crs
- 340mm o/a
- 19mm Ø bar
- 65mm pj

Finishes: ▽SS ▽PC

Sold as back to back pairs but also available as singles with face fix or rear through door fixing.

\* Combo Kits include 1 Pair Pull Handles, 1183 or 1184 Double Turn Lock Kit & 5264 60mm Floor Mount Doorstop.

\*\* Mini Lever (ML) Combo Kits include 1 Pair Pull Handles, 1364 or 1365 Mini Lever Lock Kit & 5264 60mm Floor Mount Doorstop.



Entrance Pull Handles > 304 Grade Stainless Steel

See Page 83-91 for Lock options  
See Page 92 for Care and Maintenance

Polo Pull Handles

7098	7099	7100 1221 Combo* 1366 ML Combo**	7101	7102
------	------	--	------	------

NEW NEW NEW NEW NEW

1221-SS

Finishes: ▶SS ▶BLK, GN (where shown) ▶PC

270mm crs 300mm o/a 30 x 15mm bar 50mm pj	410mm crs 450mm o/a 40 x 20mm bar 60mm pj	560mm crs 600mm o/a 40 x 20mm bar 60mm pj	860mm crs 900mm o/a 40 x 20mm bar 60mm pj	1160mm crs 1200mm o/a 40 x 20mm bar 60mm pj
--	--	--	--	--

> All Stainless/Brass components

Sold as back to back pairs but also available as singles with face fix or rear through door fixing.

\* Combo Kits include 1 Pair Pull Handles, 1183 or 1184 Double Turn Lock Kit & 5264 60mm Floor Mount Doorstop.  
\*\* Mini Lever (ML) Combo Kits include 1 Pair Pull Handles, 1364 or 1365 Mini Lever Lock Kit & 5264 60mm Floor Mount Doorstop.

Entrance Pull Handles > 304 Grade Stainless Steel

See Page 83-91 for Lock options  
See Page 92 for Care and Maintenance

NEW Streamline Pull Handles

7238	7239	7240 1374 Combo* 1373 ML Combo**	7241
------	------	--	------

NEW

Finishes: ▶BLK, SS ▶PC

275mm crs 300mm o/a 25 x 13mm bar 50mm pj	420mm crs 450mm o/a 30 x 15mm bar 58mm pj	570mm crs 600mm o/a 30 x 15mm bar 58mm pj	870mm crs 900mm o/a 30 x 15mm bar 58mm pj
--	--	--	--

> All Stainless/Brass components  
> Curved ends, no sharp edges to prevent catching your clothing, or small children knocking themselves on pointed corners

Sold as back to back pairs but also available as singles with face fix or rear through door fixing.

\* Combo Kits include 1 Pair Pull Handles, 1183 or 1184 Double Turn Lock Kit & 5264 60mm Floor Mount Doorstop.  
\*\* Mini Lever (ML) Combo Kits include 1 Pair Pull Handles, 1364 or 1365 Mini Lever Lock Kit & 5264 60mm Floor Mount Doorstop.

Locking Pull Handle

7154

> Includes 5 Keys and dust socket  
> Suitable for glass doors 10-16mm thick

1100mm crs  
1500mm o/a  
35mm Ø  
85mm pj

Finishes: ▶SS ▶PC

Accessories

SP7154  
Keyed alike barrel for 7154 Pull Handle

1287  
Key blanks to suit 7154 Locking Pull Handle

Entrance Pull Handles > 304 Grade Stainless Steel & Solid Brass

Entrance Pull Handles > Offset 304 Grade Stainless Steel

See Page 83-91 for Lock options  
See Page 92 for Care and Maintenance

See Page 83-91 for Lock options  
See Page 92 for Care and Maintenance

Marco Pull Handles

7187 7188 7189 7190

1326 Combo\*  
1367 ML Combo\*\*

260mm crs  
300mm o/a  
20 x 10mm bar  
50mm pj

400mm crs  
450mm o/a  
25 x 13mm bar  
60mm pj

550mm crs  
600mm o/a  
25 x 13mm bar  
60mm pj

850mm crs  
900mm o/a  
25 x 13mm bar  
60mm pj

Finishes: ▣BLK, ▣SS  
▣PC

Sold as back to back pairs but also available as singles with face fix or rear through door fixing.

Solid Brass Handles

7024

RH LH

Create a unique visual impact by installing sculptured solid brass Pull Handles by Windsor.

300mm crs  
80mm pj

Finishes: ▣BN, ▣SC, ▣UB  
▣AB, ▣NB, ▣OR, ▣PB, ▣PC, ▣RB

7024-BN / 1150-BN

Nitro Pull Handles

7128 7129 7130 7131

1238 Combo\*  
1369 ML Combo\*\*

280mm crs  
300mm o/a  
20 x 20mm bar  
30mm Offset  
50mm pj

425mm crs  
450mm o/a  
25 x 25mm bar  
35mm Offset  
60mm pj

575mm crs  
600mm o/a  
25 x 25mm bar  
35mm Offset  
60mm pj

875mm crs  
900mm o/a  
25 x 25mm bar  
35mm Offset  
60mm pj

Finishes: ▣SS, ▣BLK (where shown)  
▣PC

Sold as back to back pairs but also available as singles with face fix or rear through door fixing.

Curved Nitro Pull Handles

7182 7183

425mm crs  
450mm o/a  
25 x 25mm bar  
78mm Offset  
60mm pj

575mm crs  
600mm o/a  
25 x 25mm bar  
85mm Offset  
60mm pj

Finishes: ▣SS ▣PC

\* Combo Kits include 1 Pair Pull Handles, 1183 or 1184 Double Turn Lock Kit & 5264 60mm Floor Mount Doorstop.  
\*\* Mini Lever (ML) Combo Kits include 1 Pair Pull Handles, 1364 or 1365 Mini Lever Lock Kit & 5264 60mm Floor Mount Doorstop.

\* Combo Kits include 1 Pair Pull Handles, 1183 or 1184 Double Turn Lock Kit & 5264 60mm Floor Mount Doorstop.  
\*\* Mini Lever (ML) Combo Kits include 1 Pair Pull Handles, 1364 or 1365 Mini Lever Lock Kit & 5264 60mm Floor Mount Doorstop.



Entrance Pull Handles > Offset 304 Grade Stainless Steel

See Page 83-91 for Lock options  
See Page 92 for Care and Maintenance

Square Profile

25mm Offset  
7064

7065



276mm crs  
450mm o/a  
25 x 25mm bar  
65mm pj

426mm crs  
600mm o/a  
25 x 25mm bar  
65mm pj

Square Offsets

Code	crs (mm)	o/a (mm)	Bar Size (mm)	pj (mm)
7145	726	900	25 x 25	65
7146	1026	1200	25 x 25	65
7147	1626 +Mid Point	1800	25 x 25	65

Finishes: ▼SS ▼PC

Round Profile

25mm Offset  
7027

7028



^ 7028-SS

250mm crs  
450mm o/a  
32mm Ø bar  
70mm pj

400mm crs  
600mm o/a  
32mm Ø bar  
70mm pj

Round Offsets

Code	crs (mm)	o/a (mm)	Bar Ø (mm)	pj (mm)
7142	700	900	32	70
7143	1000	1200	32	70
7144	1600 +Mid Point	1800	32	70

7181



568mm crs  
600mm o/a  
32mm Ø bar  
55mm Offset  
81mm pj

Entrance Pull Handles > 316 Marine Grade Stainless Steel - Tubular

See Page 83-91 for Lock options  
See Page 92 for Care and Maintenance

Round Profile



^ 7126-SS / 1140-SS / 8003E-BN / 1148-BN / 1144-SS

7063

7125

7126

7127

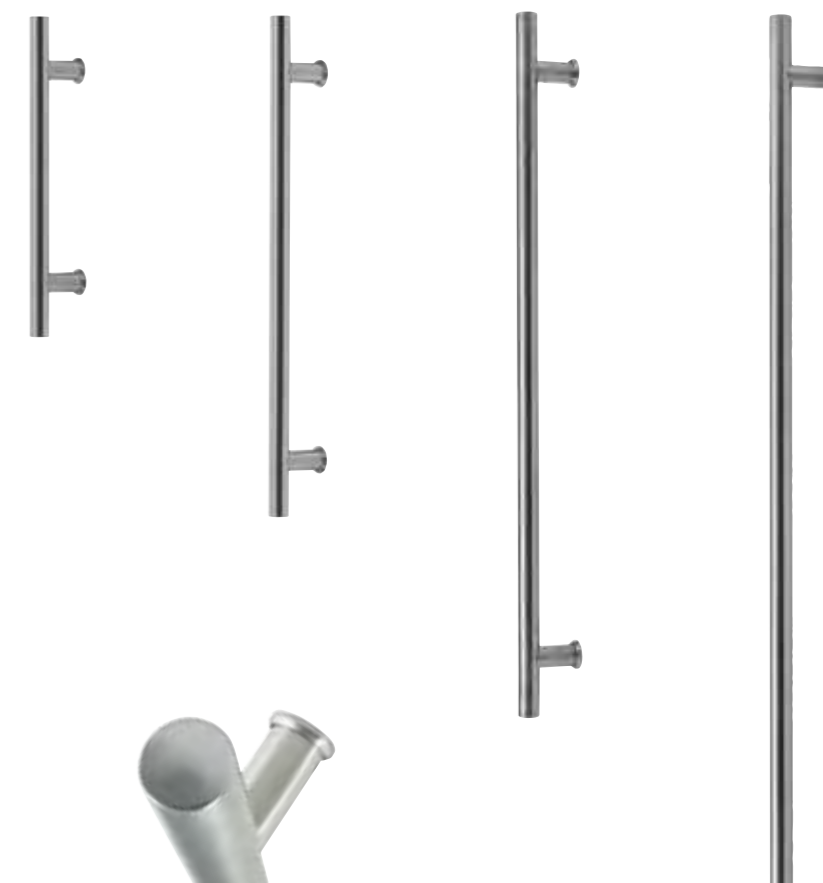

> Marine grade stainless steel handles - the ultimate in durability  
> All Stainless/Brass components

200mm crs  
300mm o/a  
19mm Ø bar  
52mm pj

350mm crs  
450mm o/a  
19mm Ø bar  
52mm pj

500mm crs  
600mm o/a  
19mm Ø bar  
52mm pj

800mm crs  
900mm o/a  
19mm Ø bar  
52mm pj

Finishes: ▼SS ▼PC

Sold as back to back pairs, also available as singles with face fix or rear through door fixing.

Sold as back to back pairs but also available as singles with face fix or rear through door fixing.

This 19mm range of pulls is manufactured from solid bar. With our custom length option we can supply you any length up to 2.4 metres.

Entrance Pull Handles > Solid Bar 19mm 304 Grade Stainless Steel

See Page 83-91 for Lock options  
See Page 92 for Care and Maintenance

Round Profile

- 7119 Straight (Pic)  
7159 Offset
- 7120 Straight (Pic)  
7160 Offset
- 7121 Straight  
7161 Offset (Pic)
- 7122 Straight (Pic)  
7162 Offset
- 7123 Straight (Pic)  
7163 Offset
- 7124 Straight (Pic)  
7164 Offset

19mm Custom Length Option

200mm crs  
300mm o/a  
19mm Ø bar  
52mm pj

350mm crs  
450mm o/a  
19mm Ø bar  
52mm pj

500mm crs  
600mm o/a  
19mm Ø bar  
52mm pj

800mm crs  
900mm o/a  
19mm Ø bar  
52mm pj

1100mm crs  
1200mm o/a  
19mm Ø bar  
52mm pj

Any length to 2.4m  
(Standard leg crs  
config. 100mm  
less than o/a  
measurement)  
52mm pj

Finishes: ▣SS ▣PC

> All Stainless/Brass components

Sold as back to back pairs but also available as singles with face fix or rear through door fixing.

Entrance Pull Handles > 304 Grade Stainless Steel

See Page 83-91 for Lock options  
See Page 92 for Care and Maintenance

Round Profile

- 7025
- 7026  
1232 Combo\*  
1370 ML Combo\*\*
- 7092
- 7093
- 7094

1800mm

7025-SS / 1150-BN

250mm crs  
450mm o/a  
32mm Ø bar  
78mm pj

400mm crs  
600mm o/a  
32mm Ø bar  
78mm pj

700mm crs  
900mm o/a  
32mm Ø bar  
78mm pj

1000mm crs  
1200mm o/a  
32mm Ø bar  
78mm pj

1600mm crs  
+ Mid Point  
1800mm o/a  
32mm Ø bar  
78mm pj

Finishes: ▣SS ▣BLK (where shown) ▣PC

> All Stainless/Brass components

Sold as back to back pairs but also available as singles with face fix or rear through door fixing.

\* Combo Kits include 1 Pair Pull Handles, 1183 or 1184 Double Turn Lock Kit & 5264 60mm Floor Mount Doorstop.

\*\* Mini Lever (ML) Combo Kits include 1 Pair Pull Handles, 1364 or 1365 Mini Lever Lock Kit & 5264 60mm Floor Mount Doorstop.



Entrance Pull Handles > 304 Grade Stainless Steel

See Page 83-91 for Lock options  
See Page 92 for Care and Maintenance  
Fixings supplied for both timber and glass doors from 8mm-50mm thickness

Square Profile

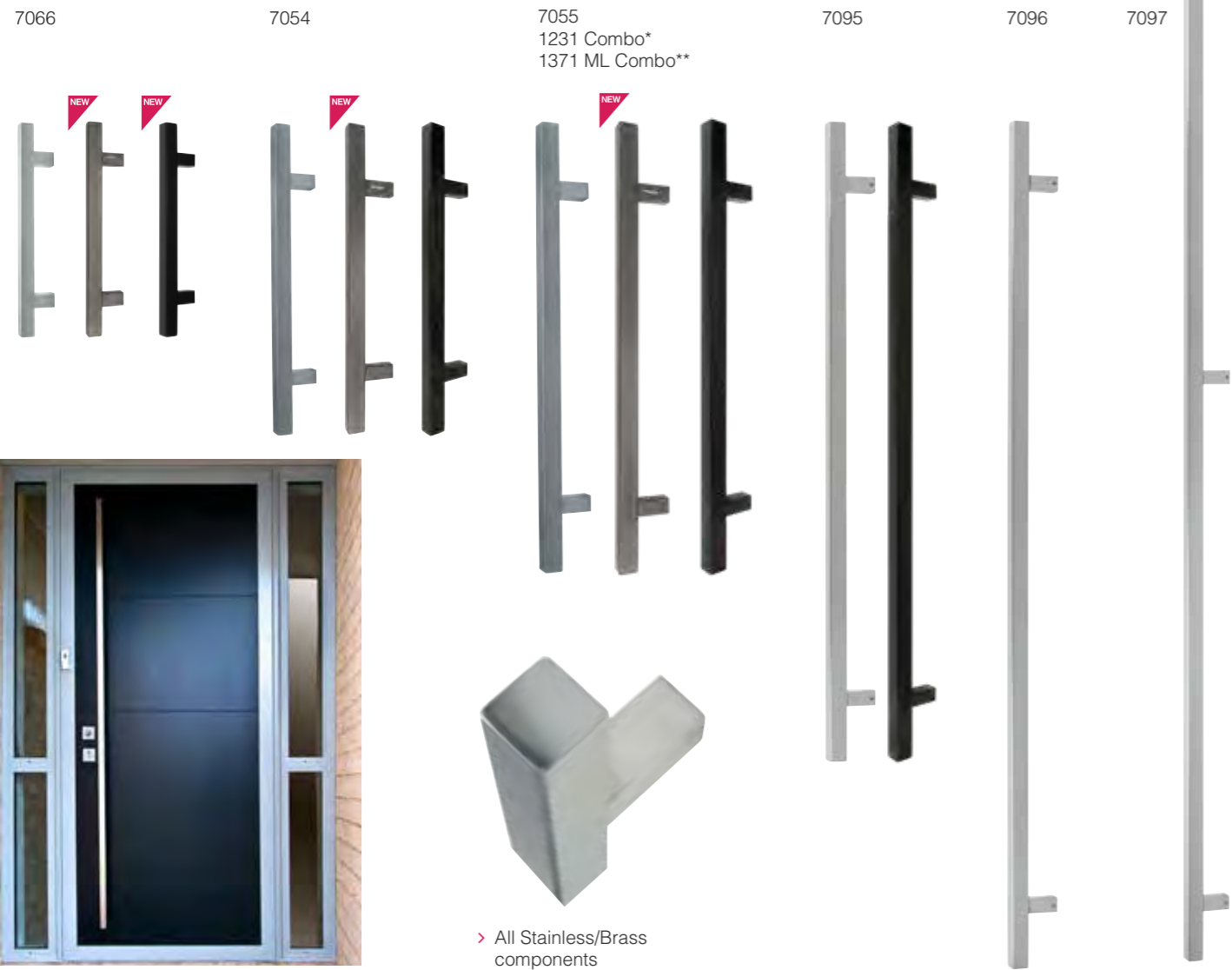

7066	7054	7055 1231 Combo* 1371 ML Combo**	7095	7096	7097
200mm crs 300mm o/a 20 x 20mm bar 50mm pj	276mm crs 450mm o/a 25 x 25mm bar 68mm pj	426mm crs 600mm o/a 25 x 25mm bar 68mm pj	726mm crs 900mm o/a 25 x 25mm bar 68mm pj	1026mm crs 1200mm o/a 25 x 25mm bar 68mm pj	1626mm crs + Mid Point 1800mm o/a 25 x 25mm bar 68mm pj

Finishes: ▶SS  
▶BLK, GN (where shown)  
▶PC

Sold as back to back pairs but also available as singles with face fix or rear through door fixing.

\* Combo Kits include 1 Pair Pull Handles, 1183 or 1184 Double Turn Lock Kit & 5264 60mm Floor Mount Doorstop.  
\*\* Mini Lever (ML) Combo Kits include 1 Pair Pull Handles, 1364 or 1365 Mini Lever Lock Kit & 5264 60mm Floor Mount Doorstop.

Entrance Pull Handles > Solid Brass Gripsets, Pull Handles & Push Plates

Gripsets

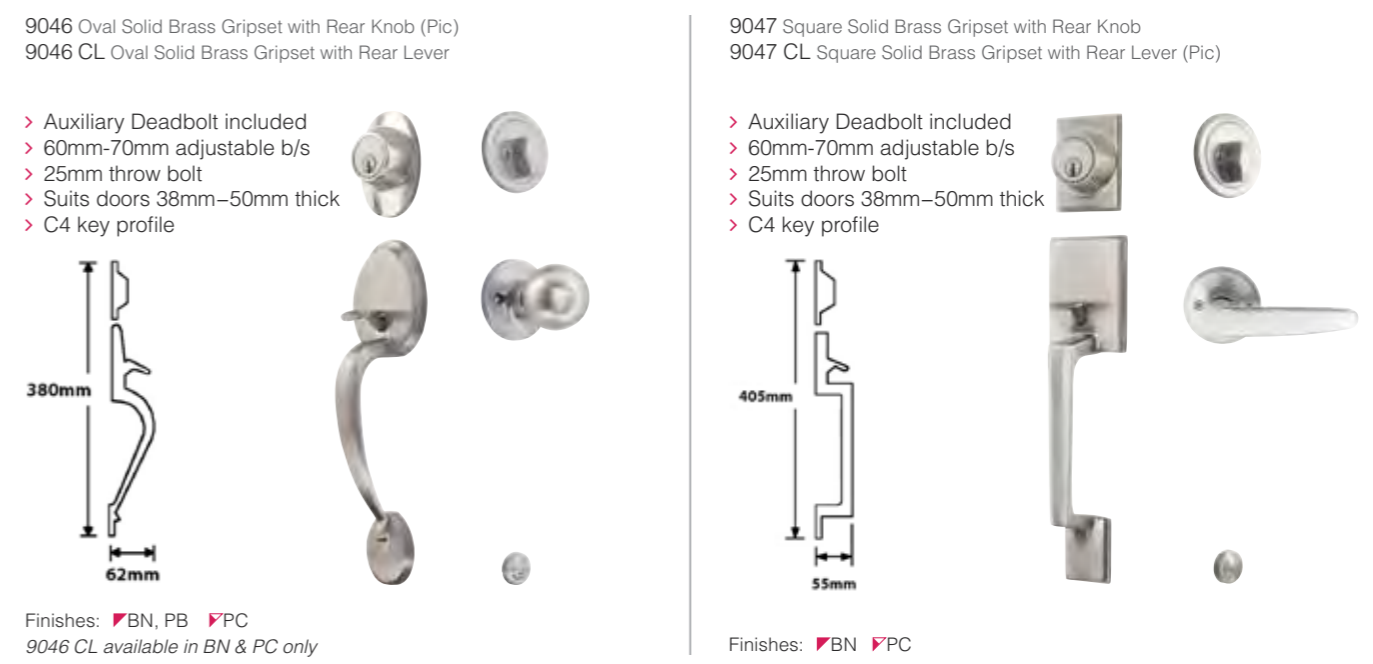

Finishes: ▶BN, PB ▶PC  
9046 CL available in BN & PC only

Finishes: ▶BN ▶PC

Pull Handles On Plate



7184 Heavy Duty Solid Pull  
300mm x 100mm Plate

7165 Tubular Pull  
7168 Heavy Duty Solid Pull  
300mm x 65mm Plate  
16mm x 250mm D-Pull

Finishes: SS ▶PC

Push Plates



7185 300mm x 100mm Plate

7166 300mm x 65mm Plate (Pic)

7167 300mm x 100mm Plate

Finishes: SS ▶PC

Melo & Minerva Style Pull Handles



> Available as back to back pairs (BB) or face fixed single (FF)  
> Recommended for interior use only  
> Ideal for use on double doors between lounge & dining rooms

Minerva  
7170 224mm crs  
254mm o/a  
36mm pj

7171 288mm crs  
318mm o/a  
36mm pj

Melo  
7173 224mm crs  
240mm o/a  
33mm pj

7174 288mm crs  
304mm o/a  
33mm pj

Finishes: ▶BN, SC ▶PC

# Door Furniture Italian

Entrance Pull Handles > Brass Pull Handles

See Page 83-91 for Lock options



**NEW** Brass Pull Handles

8190



Shown in MB



210mm crs  
300mm o/a  
19mm Ø bar  
52mm pj

8191



Shown in UB

300mm crs  
400mm o/a  
19mm Ø bar  
52mm pj

8192



Shown in OR



210mm crs  
300mm o/a  
17mm x 17mm bar  
53mm pj

8193



Shown in UB



210mm crs  
235mm o/a  
25mm x 25mm bar  
42mm pj

Finishes: ▽UB ▽AB, BB, BHB, MAB, MB, NB, OR, PB, RB, SB, VB

Sold as back to back pairs.



^ 8169 E48-OR / 1115-OR / 1148-OR

## ITALIAN by Windsor



^ 8211-MB



^ 8184-BN / 8186-BN

Handing for Single/Dummy Handles



Left Hand  
LH



Right Hand  
RH



This ultimate combination of maximum style, minimal line and modern eminence will enhance any home

- > Passage Set - includes Levers and 1172 Tubular Latch.
- > Dummy Lever - includes single Lever Handle and Dummy Spindle Mount.
- > Privacy Kit - includes Turn & Release and 1173 Tubular Bolt.
- > Deadbolt Kit - includes 8165 Escutcheons, 1135 Deadbolt and 1122 Euro Cylinder and Turn.

Door Furniture > Italian

ITALIAN  
by Windsor

Polo

8181 Dummy Lever - Single (LH or RH)  
8182 Passage Set  
39mm x 26mm Integrated Rose



8162 Lever Set  
8183 Dummy Lever - Single (LH or RH)  
8184 Passage Set  
50mm Square Rose



Finishes: ✔BN ✔PC

Polo-Nero

8177 Dummy Lever - Single (LH or RH)  
8178 Passage Set  
39mm x 26mm Integrated Rose



8160 Lever Set  
8179 Dummy Lever - Single (LH or RH)  
8180 Passage Set  
50mm Square Rose



> Black wooden insert

Finishes: ✔BN

Accessories

Privacys

Minimal Line 8163 Turn & Release  
Square Style 8164 Turn & Release  
8186 Privacy Kit 25mm x 25mm  
8187 Privacy Kit 50mm x 50mm



- > Privacy Kits include 1173 Bolt
- > Deadbolt Kit includes 8165 Escutcheons, 1135 Deadbolt & 1122 Euro Cylinder & Turn

Finishes: ✔BN ✔PC

Escutcheons

Minimal Line 8165 Escutcheons (Pair)  
Square Style 8166 Escutcheons (Pair) 50mm x 50mm  
8185 Deadbolt Kit 40mm x 25mm



8173 22mm Drill Bit  
To suit Integrated Rose series



Heavy Duty Tubular Latch

1213 45mm b/s, 67mm c/s  
1172 57mm b/s, 77mm c/s  
1242 83mm b/s, 102mm c/s



- > Double sprung, soft close
- > 25mm Ø Mortice
- > Must be used with Integrated Rose

Finishes: ✔SS ✔PC

Heavy Duty Tubular Bolt

1173 Tubular 57mm b/s, 77mm c/s  
1243 Tubular 83mm b/s, 102mm c/s



- > 25mm Ø Mortice
- > 5mm drive

Door Furniture > Italian

ITALIAN  
by Windsor



Italian Flair

- > Smooth positive handle action
- > Designed to fit your hand
- > Made from Solid Brass

> Recommended Latch code 1172  
Ref page 81

Haven

8167 Lever Set  
52mm Ø Rose  
Shown in RB



NEW 8196 Lever Set  
64mm Ø Rose  
Shown in RLB

> Large rose option ideal for retro-fit



NEW Square Longplate  
265mm x 42mm x 10mm Plate  
Shown in RLB

8194 Blank (Pic)  
8194 L Keyhole  
8194 E48 Euro  
8194 E85 Euro



Oval Longplate  
255mm x 42mm x 10mm Plate  
Shown in PB

8168 Blank (Pic)  
8168 L Keyhole  
8168 E48 Euro  
8168 E85 Euro



Traditional Longplate  
255mm x 50mm x 10mm Plate  
Shown in SC

8169 Blank (Pic)  
8169 L Keyhole  
8169 E48 Euro  
8169 E85 Euro



Hermitage

8170 Lever Set  
52mm Ø Rose  
Shown in PB



NEW 8197 Lever Set  
64mm Ø Rose  
Shown in RLB

> Large rose option ideal for retro-fit



NEW Square Longplate  
265mm x 42mm x 10mm Plate  
Shown in RLB

8195 Blank (Pic)  
8195 L Keyhole  
8195 E48 Euro  
8195 E85 Euro



Oval Longplate  
255mm x 42mm x 10mm Plate  
Shown in PB

8171 Blank (Pic)  
8171 L Keyhole  
8171 E48 Euro  
8171 E85 Euro



Traditional Longplate  
255mm x 50mm x 10mm Plate  
Shown in PB

8172 Blank (Pic)  
8172 L Keyhole  
8172 E48 Euro  
8172 E85 Euro



Finishes

✔Standard Stock Finishes  
1-2 Day Ordering Leadtime



✔Special Finishes  
14 Day Ordering Leadtime



These Windsor styles created by the best Italian designers radiate charm, excellence and class - enhancing the beauty of any décor

Door Furniture > Italian



> Recommended Latch code 1172  
Ref page 81

Federal

**Square Longplate**  
265mm x 42mm x 10mm Plate  
Shown in SC

- 8225 Blank Plate (Pic)
- 8225 L Standard Keyhole
- 8225 E48 Euro Keyhole
- 8225 E85 Euro Keyhole



**8221 Lever Set**  
52mm Ø Rose  
Shown in BB



**8226 Lever Set**  
64mm Ø Rose  
Shown in RLB

> Large rose option ideal for retro-fit



Finishes

Standard Stock Finishes  
1-2 Day Ordering Leadtime

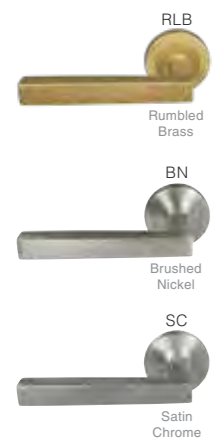

Special Finishes  
14 Day Ordering Leadtime

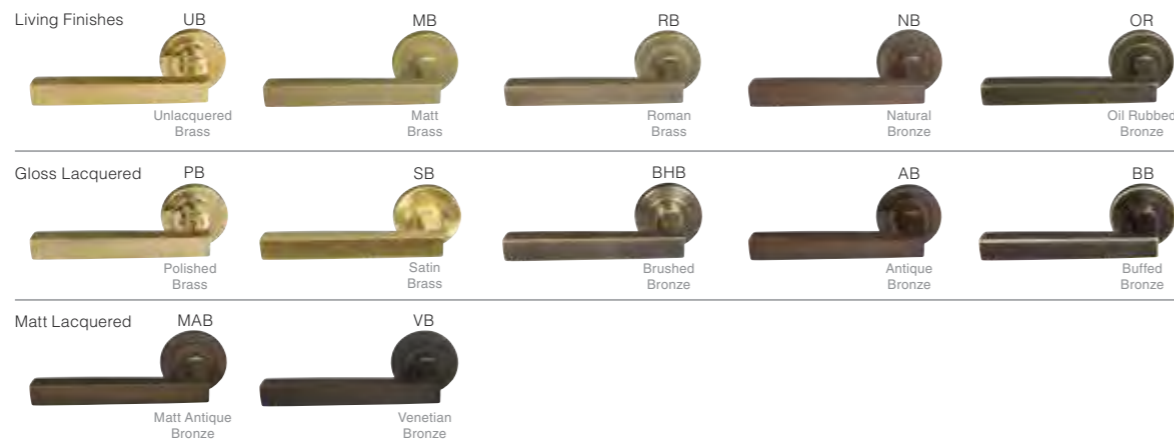

Door Furniture > Italian



> Recommended Latch code 1172  
Ref page 81

Villa

**Oval Longplate**  
255mm x 42mm x 10mm Plate  
Shown in RLB

- 8233 Blank Plate (Pic)
- 8233 L Standard Keyhole
- 8233 E48 Euro Keyhole
- 8233 E85 Euro Keyhole



**Traditional Longplate**  
255mm x 50mm x 10mm Plate  
Shown in RLB

- 8234 Blank Plate (Pic)
- 8234 L Standard Keyhole
- 8234 E48 Euro Keyhole
- 8234 E85 Euro Keyhole



**8231 Lever Set**  
52mm Ø Rose  
Shown in MB



**8236 Lever Set**  
64mm Ø Rose  
Shown in RLB

> Large rose option ideal for retro-fit



Finishes

Standard Stock Finishes  
1-2 Day Ordering Leadtime



Special Finishes  
14 Day Ordering Leadtime

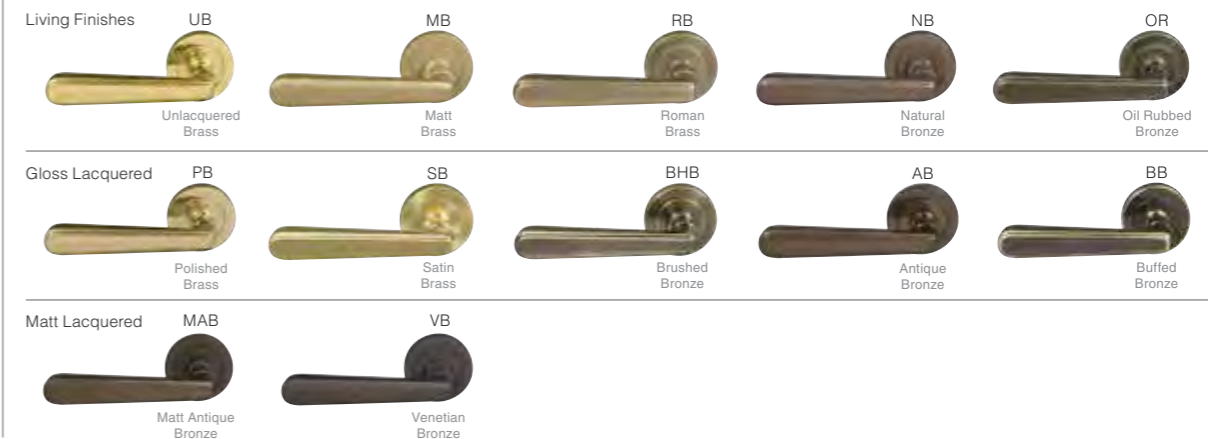

Door Furniture > Italian

NEW ITALIAN by Windsor



- Italian Flair
- > Smooth positive handle action
  - > Designed to fit your hand
  - > Made from Solid Brass

> Recommended Latch code 1172  
Ref page 81

Charleston

Square Longplate  
265mm x 42mm x 10mm Plate  
Shown in RLB

- 8205 Blank Plate (Pic)
- 8205 L Standard Keyhole
- 8205 E48 Euro Keyhole
- 8205 E85 Euro Keyhole



8201 Lever Set  
52mm Ø Rose  
Shown in OR



8206 Lever Set  
64mm Ø Rose  
Shown in BN

> Large rose option ideal for retro-fit



Finishes

Standard Stock Finishes  
1-2 Day Ordering Leadtime

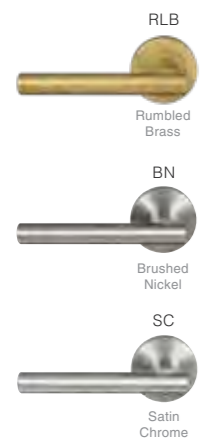

Special Finishes  
14 Day Ordering Leadtime

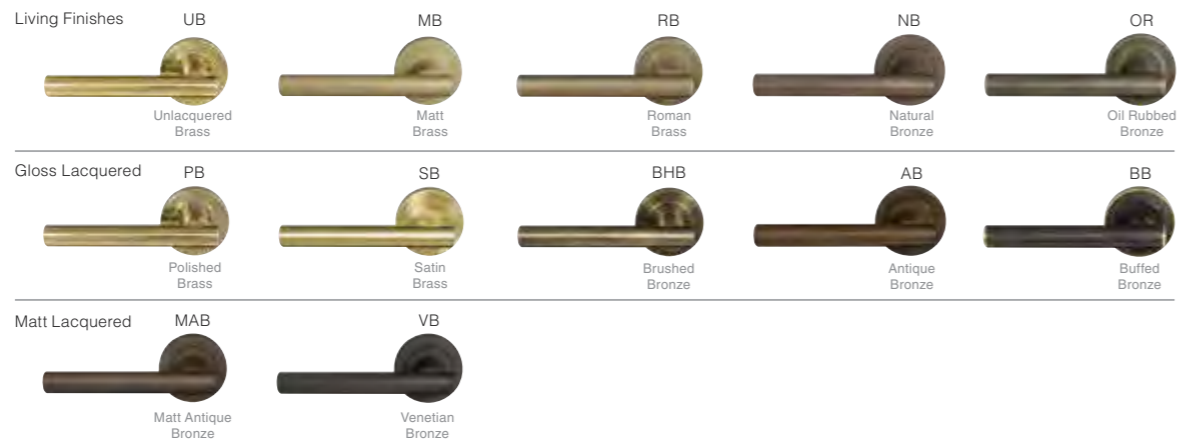

Door Furniture > Italian

NEW ITALIAN by Windsor



> Recommended Latch code 1172  
Ref page 81

Chalet

Square Longplate  
265mm x 42mm x 10mm Plate  
Shown in BN

- 8215 Blank Plate (Pic)
- 8215 L Standard Keyhole
- 8215 E48 Euro Keyhole
- 8215 E85 Euro Keyhole

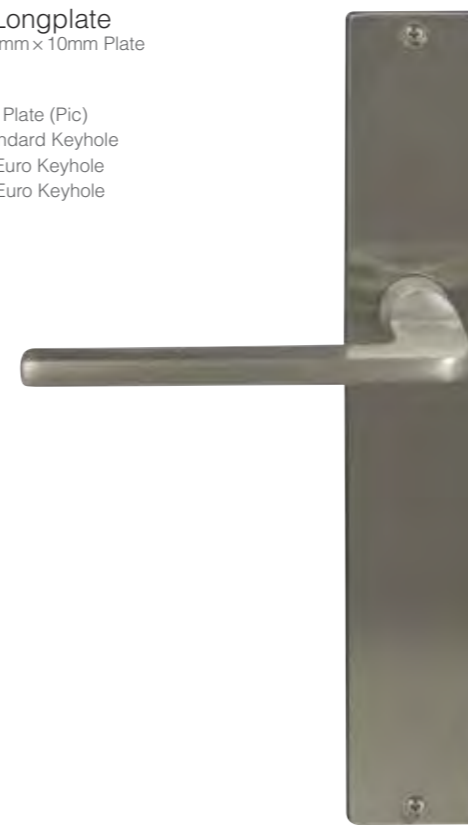

8211 Lever Set  
52mm Ø Rose  
Shown in NB



8216 Lever Set  
64mm Ø Rose  
Shown in RLB

> Large rose option ideal for retro-fit



Finishes

Standard Stock Finishes  
1-2 Day Ordering Leadtime

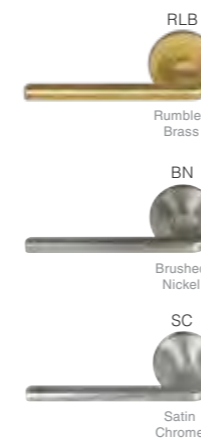

Special Finishes  
14 Day Ordering Leadtime

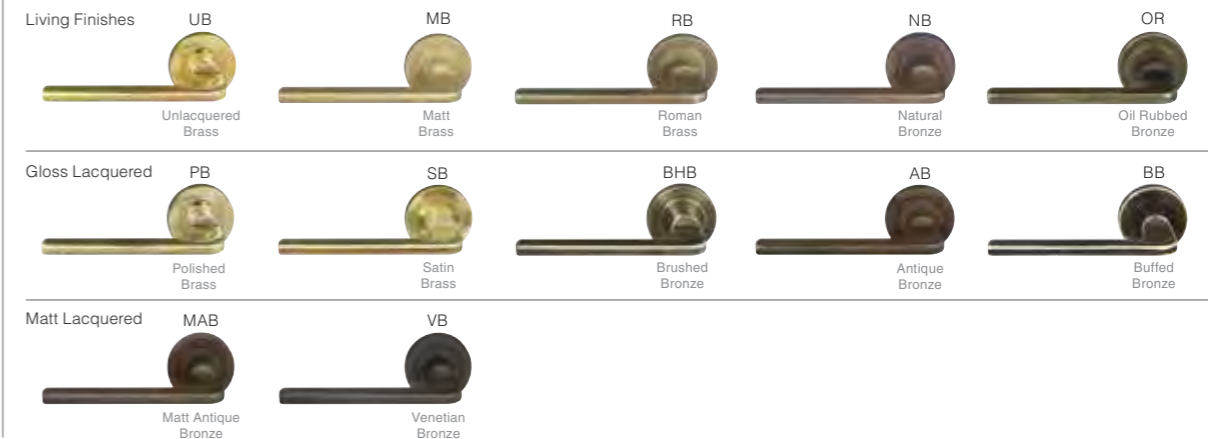



Door Furniture > Italian



Chateau

8029 Lever Set  
50mm Ø Rose  
Shown in PB



> Recommended Latch code 1172  
Ref page 84

Lever Set  
236mm x 37mm x 8mm Plate  
Shown in SC

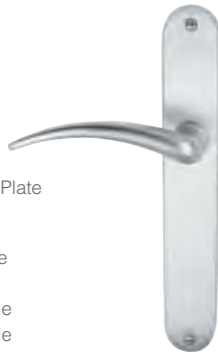

8027 Standard Keyhole  
8028 Blank Plate (Pic)  
8028 E48 Euro Keyhole  
8028 E85 Euro Keyhole

Finishes: ▽PB, SC, UB ▽AB, NB, OR, PC, RB, SB

Classic

8035 Lever Set  
50mm Ø Rose  
Shown in SB



> Recommended Latch code 1172  
Ref page 84

Lever Set  
236mm x 37mm x 8mm Plate  
Shown in PB



8033 Standard Keyhole  
8034 Blank Plate  
8034 E48 Euro Keyhole (Pic)  
8034 E85 Euro Keyhole

Ascot

3009 Lever Set  
60mm Ø Rose  
Shown in SC



> Recommended Latch code 1172  
Ref page 84

Lever Set  
236mm x 37mm x 8mm Plate  
Shown in PB



8048 Standard Keyhole  
8049 Blank Plate  
8049 E48 Euro Keyhole (Pic)  
8049 E85 Euro Keyhole (Pic)

The perfect accessory range to complement the Italian Door Furniture in the finish of your choice

Door Furniture > Solid Brass Accessories



Sliding Door Hardware

8079 Sliding Door Kit  
120mm x 34mm



8088 Door Edge Pull  
29mm Ø  
24mm hole pattern for install



▽AB, BN, PB, SC, UB  
▽BB, BHB, MAB, MB, NB, OR, PC, RB, SB, VB

8141 Flush Pull  
120mm x 34mm



Spring Catches

5194 Standard



> Length options -  
Ref page 64

▽BN, PB, SC, UB  
▽AB, BB, BHB, MAB, MB, NB, OR, PC, RB, SB, VB

Reverse Barrel Bolts

Straight Throw

5225  
150mm x 31mm  
9.6mm pin  
40mm throw



Necked Throw

5272 (Pic)  
125mm x 31mm



Necked Outward  
25mm throw  
16mm Offset

> For more options - ref page 54

▽AB, BN, PB, SC, UB  
▽BB, BHB, MAB, MB, NB, OR, PC, RB, SB, VB

Privacy Sets

8188  
50mm Ø Roses  
5mm Spindle



▽BN, PB, SC, UB  
▽AB, BB, BHB, MAB, MB, NB, OR, PC, RB, RLB  
SB, VB  
> Recommended Bolt Code 1173  
Ref. page 85

8055  
5mm Spindle



▽AB, BN, PB, SC, UB  
▽BB, BHB, MAB, MB, NB, OR, PC, RB, SB, VB  
> Recommended Lock/Latch Code 1110 -  
Ref page 85

Escutcheons

Euro  
8189 (Pair)  
50mm x 8mm Rose



▽BN, PB, SC, UB  
▽AB, BB, BHB, MAB, MB, NB, OR, PC, RB, RLB, SB, VB

The Manor Suite

8038 Lever Set  
59mm x 40mm Rose



> Recommended Latch Code 1172  
Ref page 84

Lever Set  
304mm x 46mm x 8mm Plate



8036 Standard Keyhole (Pic)  
8037 Blank Plate  
8037 E48 Euro Keyhole  
8037 E85 Euro Keyhole

8017 Privacy Turn for long back plate



8047 Turn & Escape  
> Recommended Bolt Code 1173  
Ref page 85



8046 Standard Escutcheon



8046 E Euro Escutcheon  
(Use with 85mm Euro lock)



^ 8036-AB

Finishes: ▽AF (shown) ▽AB, NB, OR, PB, PC, RB, SB, UB

Window Fasteners

5323 Wedge Fastener



> Suitable for use with weather seals

▽BN, PB, SC, UB  
▽AB, BB, BHB, MAB, MB, NB, OR, PC, RB, SB, VB

5324 Casement Fastener

5324-WS Casement Fastener to suit weather seals



> Suitable for use with weather seals

▽BN, PB, SC, UB  
▽AB, BB, BHB, MAB, MB, NB, OR, PC, RB, SB, VB

5343 Qube Window Fastener



▽BN, SC, UB ▽AB, BB, BHB, MAB, MB, NB, OR, PB, PC, RB, SB, VB

5344 Vulcan Window Fastener



Sash Hardware

5360 Hook  
39mm x 12mm  
23mm PJ



▽AB, BN, PB, SC, UB  
▽BB, BHB, MAB, MB, NB, OR, PC, RB, SB, VB

5025 Sash Fastener



Hinges

5900 Loose Pin Ball Tip  
5902 Fixed Pin Flat Tip  
101.6mm x 76.2mm  
Includes Screws



▽PB, SC, UB  
▽AB, BB, BHB, MAB, MB, NB, OR, PC, RB, SB, VB

Doorstops

5062 Height 22mm



▽AB, BN, PB, SC, UB  
▽BB, BHB, MAB, MB, NB, OR, PC, RB, SB, VB

5240 85mm x 30mm



▽AB, BN, PB, SA, UB  
▽BB, BHB, MAB, MB, NB, OR, PC, RB, SB, VB

# Door Furniture Empire & Traditional

Solid Brass combined with the warmth of genuine Italian leather, giving a touch of luxurious comfort

Door Furniture > Winchester & Deco

EMPIRE  
by Windsor

Traditional Styles,  
Timeless Elegance



^ 5070 Gloss Black



^ 3017-PB



^ 3008-E48-OR / 1115-OR / 1105-OR / 1148-OR

## Winchester

Lever Set  
152mm x 48mm x 8mm Plate

8309 Blank Plate (Pic)  
8309 L Standard Keyhole  
8309 E48 Euro Keyhole



8308 Lever Set  
50mm Ø Rose



8310 Privacy Turn & Escape  
50mm Ø Roses, 5mm Spindle



8329  
5mm Spindle



8311 L Escutcheon  
Standard Keyhole (Pic)  
8311 E Escutcheon  
Euro Keyhole  
50mm Ø x 11mm Rose



^ 8309L-ATL

Exclusively available in Antique Tan Leather finish as shown above.

## Deco

8312 Lever Set  
55mm x 10mm Square Rose



8313 Privacy Turn & Escape  
55mm x 10mm Square Roses  
5mm Spindle



8314 L Escutcheon - Standard Keyhole  
8314 E Escutcheon - Euro Keyhole  
55mm x 10mm Square Rose



8314 L

8314 E

8315 Cabinet Handle 96mm crs, 105mm o/a  
8316 Cabinet Handle 128mm crs, 137mm o/a  
8317 Cabinet Handle 160mm crs, 169mm o/a



Exclusively available in Polished Chrome with Black Leather as shown above.



Crafted from Solid Brass, this unique family of handles is designed to stand the test of time

Door Furniture > Tuscan & Magma

EMPIRE  
by Windsor



Tuscan

Lever Set  
152mm x 48mm x 8mm Plate

8320 Blank Plate (Pic)  
8320 L Standard Keyhole  
8320 E48 Euro Keyhole



Finishes: ▣VP (shown above), UB  
▣AB, NB, OR, PB, PC, RB

8319 Lever Set  
55mm x 10mm Square Rose



▣ 8319-OR / 1172 / 8321-OR / 1173

8323 Knob Set  
52mm Knob  
55mm x 10mm Square Rose



8326 Cabinet Handle  
160mm crs, 187mm o/a



8321 Privacy Turn & Escape  
55mm x 10mm Square Roses  
5mm Spindle



8322 L Escutcheon Standard Keyhole (Pic)  
8322 E Escutcheon Euro Keyhole  
55mm x 10mm Square Rose



8330 5mm Spindle



Magma

Lever Set  
225mm x 49mm x 8mm Plate

8302 Blank Plate (Pic)  
8302 L Standard Keyhole  
8302 E48 Euro Keyhole



Finishes: ▣BN (shown above), UB  
▣AB, NB, OR, PB, PC, RB

8301 Lever Set  
54mm x 10mm Square Rose



8303 Privacy Turn & Escape  
54mm x 10mm Square Roses  
5mm Spindle



8328 5mm Spindle



8304 L Escutcheon Standard Keyhole (Pic)  
8304 E Escutcheon Euro Keyhole  
54mm x 10mm Square Rose



Shown in NB

8307 Cabinet Handle  
160mm crs, 187mm o/a



Shown in OR

Shown in BN

- > Passage Set - includes Knob Set and 1101 Tubular Latch.
- > Privacy Set - includes Knob Set, 1110 Privacy Mortice, 8055 Turn and Release.
- > Euro Locking - includes Knob Set Euro, 1115 Mortice Lock, 1148 Cylinder and Turn.
- > Standard Key Locking - includes Knob Set with Standard Keyhole and 1104 5-Lever Mortice Lock.

Door Furniture > Georgian & Oval

TRADITIONAL  
by Windsor

Georgian

4006 Knob Set  
4007 Passage Set  
52mm Knob  
63mm Ø Rose



Shown in PB

4002 Knob Set  
4003 Passage Set  
52mm Knob  
105mm x 50mm Plate



Shown in PB

Knob Set  
52mm Knob  
152mm x 52mm x 8mm Plate

4001 Standard Keyhole (Pic)  
5148 Blank Plate  
5148 E48 Euro Keyhole  
4028 Passage Set  
4029 Privacy Set  
4030 Euro Locking Set  
4031 Standard Key Locking Set



Shown in PB

Finishes: ▣PB, UB  
▣AB, NB, OR, PC, RB, SB

4005 Lever Set  
57mm Ø Rose



Shown in PB

4004 Lever Set  
105mm x 50mm Plate



Shown in NB

Lever Set  
152mm x 52mm x 8mm Plate

4021 Standard Keyhole  
5149 Blank Plate (Pic)  
5149 E48 Euro Keyhole



Shown in NB

Oval Door Furniture

5071 Knob Set  
5072 Passage Set  
60mm Knob  
60mm Ø Rose



Shown in SC

Knob Set  
60mm Knob  
152mm x 43mm x 10mm Plate



Shown in PB

5137 Standard Keyhole  
5179 Blank Plate (Pic)  
5179 E48 Euro Keyhole  
5127 Passage Set  
5128 Privacy Set  
5129 Euro Locking Set  
5130 Standard Key Locking Set

Knob Set  
60mm Knob  
190mm x 63mm x 10mm Plate

5002 Standard Keyhole (Pic)  
5003 Blank Plate  
5003 E48 Euro Keyhole  
5004 Passage Set  
5005 Privacy Set  
5006 Euro Locking Set  
5007 Standard Key Locking Set



Shown in AB

Finishes: ▣AB, PB, SC, UB  
▣NB, OR, PC, RB, SB



- > Passage Set - includes Knob Set and 1101 Tubular Latch.
- > Privacy Set - includes Knob Set, 1110 Privacy Mortice, 8055 Turn and Release.
- > Euro Locking - includes Knob Set Euro, 1115 Mortice Lock, 1148 Cylinder and Turn.
- > Standard Key Locking - includes Knob Set with Standard Keyhole and 1104 5-Lever Mortice Lock.

Door Furniture > Victorian

TRADITIONAL  
by Windsor

All the features of Italian manufacture, combined with traditional Victorian styling make this collection an obvious choice in restoration.

Victorian

3009 Lever Set  
60mm Ø Rose



Shown in SB

5070 Knob Set  
5069 Passage Set (includes 1242 Latch)  
63mm Knob  
75mm Ø Rose

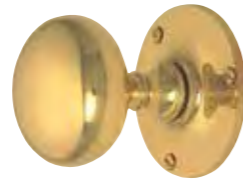

Shown in PB

3010 Knob Set  
3011 Passage Set  
52mm Knob  
60mm Ø Rose



Shown in PB

Lever Set  
150mm x 36mm x 10mm Plate

5131 Standard Keyhole (Pic)  
5132 Blank Plate  
5132 E48 Euro Keyhole



Shown in SC

Knob Set  
52mm Knob  
152mm x 43mm x 10mm Plate

3002L Standard Keyhole  
3002 Blank Plate (Pic)  
3002 E48 Euro Keyhole  
3013 Passage Set  
3014 Privacy Set  
3015 Euro Locking Set  
3016 Standard Key Locking Set



Shown in PB

Lever Set  
152mm x 43mm x 10mm Plate

3006L Standard Keyhole  
3006 Blank Plate (Pic)  
3006 E48 Euro Keyhole



Shown in SC

Lever Set  
205mm x 49mm x 10mm Plate

3007 Standard Keyhole (Pic)  
3008 Blank Plate  
3008 E48 Euro Keyhole



Shown in PB

Knob Set  
52mm Knob  
205mm x 49mm x 10mm Plate

3003 Standard Keyhole  
3004 Blank Plate (Pic)  
3004 E48 Euro Keyhole  
3017 Passage Set  
3018 Privacy Set  
3019 Euro Locking Set  
3020 Standard Key Locking Set



Shown in OR

Finishes: ▣PB, SC, UB  
▣AB, NB, OR, PC, RB, SB

Economy and quality are cleverly combined in the Belmont Range

Door Furniture > Belmont & French Door Catches

BELMONT  
by Windsor

Forged in Solid Brass, this Italian range is unmatched in quality and finish in its price bracket. This traditionally styled selection includes narrow backplates for narrow door stiles.

Belmont

7013 Lever Set  
60mm Ø Rose



Shown in RB

7012 Lever Set  
60mm Ø Rose



Shown in SC

Lever Set  
150mm x 36mm x 10mm Plate

7010 Standard Keyhole (Pic)  
7011 Blank Plate  
7011 E48 Euro Keyhole



Shown in SC

Lever Set  
150mm x 36mm x 10mm Plate

7007 Standard Keyhole  
7008 Blank Plate (Pic)  
7008 E48 Euro Keyhole



Shown in SC



7006 E48-SC / 1148-SC

Finishes: ▣PB, SC, UB  
▣AB, NB, OR, PC, RB, SB

Lever Set  
152mm x 43mm x 10mm Plate

7005 Standard Keyhole (Pic)  
7006 Blank Plate  
7006 E48 Euro Keyhole

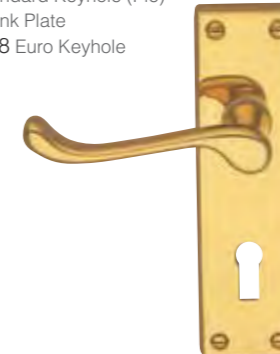

Shown in PB

French Door Catches

5138 Set (includes 5157 Handle)



5157 Handle only

5139 Set (includes 5158 Handle)



5158 Handle only

Finishes: ▣AB, PB, SC, UB  
▣NB, OR, PC, RB, SB

French Door Kit

7062



- Features
- 3 Lever medium security Lock (100 key differs)
  - Easi-T Latch Reversal System (no need to open lock case to adjust)
  - Adjustment tabs in striker to remove any door rattle
  - Suits door thickness 38mm to 42mm
  - Key blanks code 1117E available for cutting extra keys

- Contains
- 1 pair Windsor Belmont Italian door furniture code 7005
  - 1 Three Lever Mortice Lock code 1107
  - 1 Rebate Kit to suit 3 lever lock
  - 2x100mm Necked Barrel Bolts
  - Fitting instructions enclosed

Finishes: ▣PB, SC ▣AB

# Door Furniture Architectural

Contemporary door furniture featuring clean lines for that classy new home, apartment or office

Door Furniture > Architectural

ARCHITECTURAL  
by Windsor



ARCHITECTURAL  
by Windsor

PROFESSIONAL SERIES



8142-SC



8138-SC

Handing for Single/Dummy Handles



Left Hand  
LH



Right Hand  
RH



8135-SC Privacy / 8055-SC / 1173-SS / 1172-SS / 5904-SS

## Sigma

- 8142 Passage Set
- 8143 Lever Set
- 8144 Dummy Lever  
- Single (non handed)  
55mm Square Rose



## Longplate

240mm x 45mm x 10mm Plate

- 8145 Blank Plate (Pic)
- 8145 L Standard Keyhole
- 8145 E48 Euro Keyhole
- 8145 E85 Euro Keyhole



## Prisma

- 8132 Passage Set
- 8133 Lever Set
- 8134 Dummy Lever  
- Single (LH or RH) RH Pic  
55mm Square Rose



## Longplate

240mm x 45mm x 10mm Plate

- 8135 Blank Plate (Pic)
- 8135 L Standard Keyhole
- 8135 E48 Euro Keyhole
- 8135 E85 Euro Keyhole



## Matrix

- 8128 Passage Set
- 8129 Lever Set
- 8130 Dummy Lever  
- Single (non handed)  
55mm Square Rose



## Longplate

240mm x 45mm x 10mm Plate

- 8131 Blank Plate (Pic)
- 8131 L Standard Keyhole
- 8131 E48 Euro Keyhole
- 8131 E85 Euro Keyhole



Finishes: ▀BN, SC ▀PC

To modify Architectural Euro 85 longplates to suit multipoint locks, include code 1275 with your order.



- > Passage Set - includes Levers and 1131 Tubular Latch.
- > Lever Set - includes Levers only for use with Mortice Locks or when back to back on double doors (between rooms).
- > Dummy Lever - Single - Rear fix Lever and 1152 Dummy Mount for use on cupboard/wardrobe doors.

Door Furniture > Architectural

ARCHITECTURAL  
by Windsor

Quattro

- 8099 Passage Set
- 8100 Lever Set
- 8114 Dummy Lever - Single (non handed)
- 55mm Square Rose



Lever Set

240mm x 45mm x 10mm Plate

- 8126 Blank Plate (Pic)
- 8126 L Standard Keyhole
- 8126 E48 Euro Keyhole
- 8126 E85 Euro Keyhole



Finishes: ▼BN, SC ▼PC

Quantum

- 8109 Passage Set
- 8110 Lever Set
- 8115 Dummy Lever - Single (non handed)
- 55mm Square Rose



Privacy – Square

8101

- 60mm b/s Bolt
- 55mm Square Roses
- 5mm Spindle



Escutcheons

- 8102 E Euro
- 8102 O Oval
- 8136 Blank



- > Blank Escutcheon for thru-fixing Dummy Handles
- > 55mm Square Rose

Finishes: ▼BN, SC ▼PC

Avante

- 8091 Lever Set
- 8137 Passage Set
- 8138 Dummy Lever - Single (non handed)
- 55mm Ø Rose



Lever Set

233mm x 40mm x 10mm Plate

- 8090 Blank Plate (Pic)
- 8090 L Standard Keyhole
- 8090 E48 Euro Keyhole
- 8090 E85 Euro Keyhole



Lever Set

Narrow Plate Option  
233mm x 32mm x 10mm Plate

- 8103 Blank Plate
- 8103 L Standard Keyhole
- 8103 E48 Euro Keyhole
- 8103 E85 Euro Keyhole

- > Minimum Lock Backset 35mm

Finishes: ▼SC ▼PC

# Door Furniture Galaxy



7202-GN

**NEW**

GALAXY  
by Windsor

15 YEARS  
MECHANICAL  
WARRANTY

PROFESSIONAL SERIES



7211D-GN



7203-BN

To modify Architectural Euro 85 longplates to suit multipoint locks, include code 1275 with your order.

Ordering Leadtimes: ▼1-2 Days ▼14 Days

Refer Inside Front Cover for further details on ordering leadtimes



Door Furniture > Galaxy Graphite Nickel

**NEW** GALAXY  
by Windsor

GRAPHITENICKEL

Features

- > Complete House Packages in Graphite Nickel - the latest finish - from Doorstops to Flush Pulls
- > Contemporary styles, enabling you to achieve a smart look for your home
- > Designed for comfort
- > Solid zinc alloy construction
- > Easy installation
- > Suits both left and right handed doors
- > Complete the look with accessories to match

Pegasus

- 7201 Lever Set
  - 7201D Dummy Lever (non handed)
  - 7202 Passage Set
  - 7203 Privacy Set
  - 7204 Entrance Set
  - 7205 Privacy Set - Integrated
- 54mm Ø Rose



Pegasus Elite

- 7211 Lever Set
  - 7211D Dummy Lever (non handed)
  - 7212 Passage Set
  - 7213 Privacy Set
  - 7214 Entrance Set
  - 7215 Privacy Set - Integrated
- 54mm Square Rose



Phoenix

- 7221 Lever Set
  - 7221D Dummy Lever (non handed)
  - 7222 Passage Set
  - 7223 Privacy Set
  - 7224 Entrance Set
  - 7225 Privacy Set - Integrated
- 54mm Ø Rose



Finishes: █GN

Phoenix Elite

- 7231 Lever Set
  - 7231D Dummy Lever (non handed)
  - 7232 Passage Set
  - 7233 Privacy Set
  - 7234 Entrance Set
  - 7235 Privacy Set - Integrated
- 54mm Square Rose



7225-GN

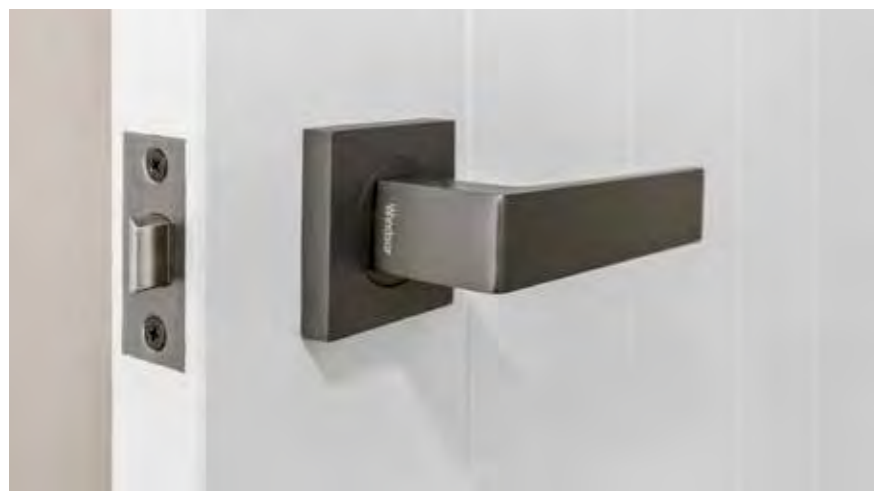

7212-GN



5331-GN

- > Lever Set - includes Levers only.
  - > Dummy Lever - includes single Lever Handle and 1152 Dummy Mount.
  - > Passage Set - includes Levers and 1357 Tubular Latch - 60mm Backset.
  - > Privacy Set - includes Levers, 60mm Backset Tubular Latch and Privacy Bolt, Turn and Escape.
  - > Entrance Set - includes Levers, 1143 Euro Mortice Lock, 7020 Escutcheons and 1148 Euro Cylinder and Turn.
  - > Integrated Privacy Set - includes Levers and 60mm Backset Tubular Privacy Latch.
- Ref Inside Back Cover for illustrations of combinations

Door Furniture > Galaxy Accessories

**NEW** GALAXY  
by Windsor

GRAPHITENICKEL

Cavity-Suites

- 5326 Passage Kit
  - 5327 Privacy Kit (Pic)
- > 65mm Ø Round
  - > 60mm Backset Bolt
  - > Includes Edge Pull
  - > Flush turn design
  - > Easy installation



Finishes: █BLK, GN, SS █PC

- 5330 Passage Kit
  - 5331 Privacy Kit (Pic)
- > 65mm x 65mm Square
  - > 60mm Backset Bolt
  - > Includes Edge Pull
  - > Flush turn design
  - > Easy installation



Sliding Door Hardware

Flush Pulls

- 5317 126mm x 42mm
- 5318 158mm x 42mm
- 5319 190mm x 42mm



Finishes: █BLK, BN, GN, MC, SC █PC

Edge Pull

- 5329 Cavity Sliding Edge Pull 29mm Ø
- 5333 Cavity Sliding Edge Pull 29mm x 29mm



> 25mm hole pattern for install

Finishes: █BLK, GN, SS █PC

Retrofit Adaptor Roses

- 9075 Press-on Integrated Privacy Adapter Rose (Pair)
- 9062 Screw-on Passage Rose (Pair)



Phoenix Lever with 9062 fitted

- > 65mm Ø x 10mm screw-on adaptor plate for Galaxy Round Rose
- > Use for 54mm hole pattern

Finishes: █BLK, BN, GN, MC █PC

Doorstops

- 5256 38mm x 38mm Floor Mount
- 5264 60mm x 38mm Floor Mount
- 5240 85mm x 30mm Concealed Skirting Fix
- 5262 80mm x 19mm Square Skirting Mount



Finishes: █BLK, BN, GN, SA █PC

Cylinder Turn

- 1148 5 pin, 70mm Key/Snib



Finishes: █BLK, BN, GN, SC █PC

Escutcheons

- 9035 54mm Ø x 10mm Roses Euro (Pair)
- 9045 54mm x 10mm Square Roses Euro (Pair)



Finishes: █BLK, BN, GN, MC, SC █PC

Radius Hinge

- 5904 89mm x 60mm x 2.5mm ¼" Radius Corners
- > Stainless Steel in Graphite Nickel with Graphite Nickel screws
- > Comes with 18mm screws
- > 25mm screws also available



Finishes: █BLK, SS, GN █PC

Vulcan Stair Rail Bracket

- 5352 Round 54mm Ø Rose
- 5353 Square 54mm Square Rose (Showing flat mount adaptor)



- > Designed to match your door hardware and accessories
- > Suits Round or Square Rail (adaptor included)
- > Suits 40mm-50mm diameter rail
- > 4 Wall Fixing Points - Concealed Fixings
- > Design exceeds standard NZS/AS 1657:1992

Finishes: █BLK, BN, GN, MC, SC █PC

Galaxy door hardware in Brushed Nickel - the perennial favourite, and Matt Chrome - a soft, understated look

Door Furniture > Galaxy Brushed Nickel & Matt Chrome



BRUSHEDNICKEL

Pegasus

- 7201 Lever Set
- 7201D Dummy Lever (non handed)
- 7202 Passage Set
- 7203 Privacy Set
- 7204 Entrance Set
- 7205 Privacy Set – Integrated
- 54mm Ø Rose



Phoenix

- 7221 Lever Set
- 7221D Dummy Lever (non handed)
- 7222 Passage Set
- 7223 Privacy Set
- 7224 Entrance Set
- 7225 Privacy Set – Integrated
- 54mm Ø Rose



Finishes: ▽BN

Pegasus Elite

- 7211 Lever Set
- 7211D Dummy Lever (non handed)
- 7212 Passage Set
- 7213 Privacy Set
- 7214 Entrance Set
- 7215 Privacy Set – Integrated
- 54mm Square Rose



Phoenix Elite

- 7231 Lever Set
- 7231D Dummy Lever (non handed)
- 7232 Passage Set
- 7233 Privacy Set
- 7234 Entrance Set
- 7235 Privacy Set – Integrated
- 54mm Square Rose



MATTCHROME

Pegasus

- 7201 Lever Set
- 7201D Dummy Lever (non handed)
- 7202 Passage Set
- 7203 Privacy Set
- 7204 Entrance Set
- 7205 Privacy Set – Integrated
- 54mm Ø Rose



Phoenix

- 7221 Lever Set
- 7221D Dummy Lever (non handed)
- 7222 Passage Set
- 7223 Privacy Set
- 7224 Entrance Set
- 7225 Privacy Set – Integrated
- 54mm Ø Rose



Finishes: ▽MC ▽PC

Pegasus Elite

- 7211 Lever Set
- 7211D Dummy Lever (non handed)
- 7212 Passage Set
- 7213 Privacy Set
- 7214 Entrance Set
- 7215 Privacy Set – Integrated
- 54mm Square Rose



Phoenix Elite

- 7231 Lever Set
- 7231D Dummy Lever (non handed)
- 7232 Passage Set
- 7233 Privacy Set
- 7234 Entrance Set
- 7235 Privacy Set – Integrated
- 54mm Square Rose



# Door Furniture Astron



ASTRON  
by Windsor



PROFESSIONALSERIES



^ 7080-BN



^ 7150-BN

Handing for Single/Dummy Handles



^ 7060-BN

Our Astron Series door furniture is perfect for the modern home

Door Furniture > Astron

ASTRON  
by Windsor

See Page 43 for plate options

Features

- > Ergonomic designs for user comfort
- > Fine zinc alloy construction giving a solid well-finished handle
- > 55mm Rose with screw on covers to conceal fixings
- > Through door bolts and grub screws provide a very solid mount
- > Fire rated 60 minutes with approved mortices and doors
- > 25mm drill-out for installation

Vulcan

- 7149 Lever Set
- 7149 D Dummy Lever - Single (non handed)
- 7150 Passage Set
- 7151 Privacy Set
- 7153 Entrance Set
- 7198 Privacy Set – Integrated
- 55mm Ø Rose



Longplate

233mm x 40mm x 10mm Plate

- 7148 Blank Plate (Pic)
- 7148 L Standard Keyhole
- 7148 E48 Euro Keyhole
- 7148 E85 Euro Keyhole
- 7152 Entrance Set



Titan

- 7113 Lever Set
- 7113 D Dummy Lever - Single (LH or RH) RH Pic
- 7114 Passage Set
- 7115 Privacy Set
- 7117 Entrance Set
- 7197 Privacy Set – Integrated
- 55mm Ø Rose



Longplate

233mm x 32mm x 10mm Plate

- 7112 Blank Plate (Pic)
- 7112 L Standard Keyhole
- 7112 E48 Euro Keyhole
- 7112 E85 Euro Keyhole
- 7116 Entrance Set



- > Lever Set - includes Levers only.
  - > Dummy Lever - includes single Lever Handle and 1152 Dummy Mount.
  - > Passage Set - includes Levers, 1131 Tubular Latch - 60mm Backset.
  - > Privacy Set - includes Levers, 1131 Tubular Latch and 7032 Privacy Bolt, Turn and Escape.
  - > Integrated Privacy Set - includes Levers and 60mm Backset Tubular Privacy Latch.
  - > Rose Entrance Set - includes Levers, 1143 Euro Mortice Lock, 7020 Escutcheons and 1148 Euro Cylinder and Turn.
  - > Long Plate Entrance Set - includes Euro 85 Longplate, 1143 Euro Lockcase and 1148 Euro Cylinder and Turn.
- Ref Inside Back Cover for illustrations of combinations

Door Furniture > Astron

ASTRON  
by Windsor

See Page 43 for plate options

Vector

- 7106 Lever Set
- 7106 D Dummy Lever - Single (non handed)
- 7107 Passage Set
- 7108 Privacy Set
- 7110 Entrance Set
- 7196 Privacy Set – Integrated
- 55mm Ø Rose



Longplate

233mm x 32mm x 10mm Plate

- 7105 Blank Plate (Pic)
- 7105 L Standard Keyhole
- 7105 E48 Euro Keyhole
- 7105 E85 Euro Keyhole
- 7109 Entrance Set



Qube

- 7058 Lever Set
- 7058 D Dummy Lever - Single (non handed)
- 7059 Passage Set
- 7060 Privacy Set
- 7085 Entrance Set
- 7195 Privacy Set – Integrated (Pic)
- 55mm Ø Rose



Longplate

233mm x 32mm x 10mm Plate

- 7057 Blank Plate (Pic)
- 7057 L Standard Keyhole
- 7057 E48 Euro Keyhole
- 7057 E85 Euro Keyhole
- 7061 Entrance Set



Juno

- 7019 Lever Set
- 7019 D Dummy Lever - Single (LH or RH) RH Pic
- 7036 Passage Set
- 7037 Privacy Set
- 7081 Entrance Set
- 7192 Privacy Set – Integrated
- 55mm Ø Rose

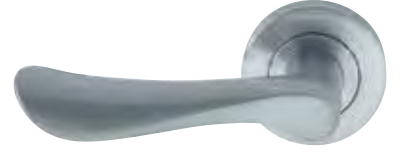

Longplate

233mm x 32mm x 10mm Plate

- 7046 Blank Plate (Pic)
- 7046 L Standard Keyhole
- 7046 E48 Euro Keyhole
- 7046 E85 Euro Keyhole
- 7038 Entrance Set



7046-PC (Black Sand)

Finishes: ▼BN, SC ▼PC

To modify Astron Euro 85 longplates to suit multipoint locks, include code 1274 with your order.

Finishes: ▼BN, SC ▼PC

To modify Astron Euro 85 longplates to suit multipoint locks, include code 1274 with your order.



- > Lever Set - includes Levers only.
  - > Dummy Lever - includes single Lever Handle and 1152 Dummy Mount.
  - > Passage Set - includes Levers, 1131 Tubular Latch - 60mm Backset.
  - > Privacy Set - includes Levers, 1131 Tubular Latch and 7032 Privacy Bolt, Turn and Escape.
  - > Integrated Privacy Set - includes Levers and 60mm Backset Tubular Privacy Latch.
  - > Rose Entrance Set - includes Levers, 1143 Euro Mortice Lock, 7020 Escutcheons and 1148 Euro Cylinder and Turn.
  - > Long Plate Entrance Set - includes Euro 85 Longplate, 1143 Euro Lockcase and 1148 Euro Cylinder and Turn.
- Ref Inside Back Cover for illustrations of combinations

Door Furniture > Astron

ASTRON  
by Windsor

See Page 43 for plate options

Apollo

- 7015 Lever Set
- 7015D Dummy Lever - Single (LH or RH) RH Pic
- 7033 Passage Set
- 7034 Privacy Set
- 7080 Entrance Set
- 7191 Privacy Set - Integrated 55mm Ø Rose

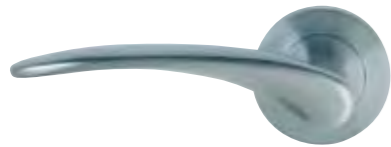

Spectra

- 7050 Lever Set
- 7050D Dummy Lever - Single (LH or RH) RH Pic
- 7051 Passage Set
- 7052 Privacy Set
- 7084 Entrance Set
- 7194 Privacy Set - Integrated 55mm Ø Rose

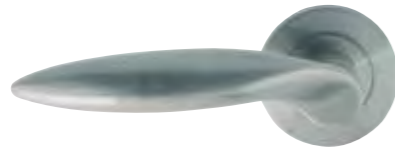

Luna

- 7030 Lever Set
- 7030 D Dummy Lever - Single (non handed)
- 7042 Passage Set
- 7043 Privacy Set
- 7083 Entrance Set
- 7193 Privacy Set - Integrated 55mm Ø Rose



Longplate

233mm x 32mm x 10mm Plate

- 7045 Blank Plate (Pic)
- 7045 L Standard Keyhole
- 7045 E48 Euro Keyhole
- 7045 E85 Euro Keyhole
- 7035 Entrance Set



Longplate

233mm x 32mm x 10mm Plate

- 7049 Blank Plate (Pic)
- 7049 L Standard Keyhole
- 7049 E48 Euro Keyhole
- 7049 E85 Euro Keyhole
- 7053 Entrance Set



Longplate

233mm x 32mm x 10mm Plate

- 7048 Blank Plate (Pic)
- 7048 L Standard Keyhole
- 7048 E48 Euro Keyhole
- 7048 E85 Euro Keyhole
- 7044 Entrance Set



Finishes: ▽BN, SC ▽PC

To modify Astron Euro 85 longplates to suit multipoint locks, include code 1274 with your order.

Door Furniture > Astron Accessories

ASTRON  
by Windsor

Tubular Latch

1131 60mm b/s



- > Plastic recess shield included for tidy installation of strike
- > 45° short action for ease of use

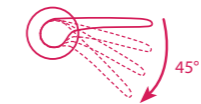

Finishes: ▽BLK, BN, SC ▽AB, PC

**NEW** Heavy Duty Tubular Latch

1360 60mm b/s, 25mm Ø, 80mm c/s

- > Dual springing system for extra soft closing action
- > Short 45° lever action makes opening your door easy
- > Standard 25mm crop-out

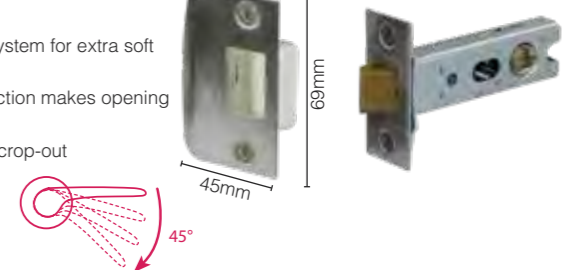

Auxiliary Privacy Bolt

Sold as complete kit only

7076 Indicator

52.5mm Roses  
60mm b/s Bolt  
5mm Spindle



Finishes: ▽SS

7032

54mm Ø Roses  
60mm b/s Bolt  
5mm Spindle



Finishes: ▽BN, SC  
▽PC

Escutcheons

7020 55mm Ø x 11mm Rose, Concealed Fix



7056 Dummy Blank



Finishes: ▽BN, SC  
▽PC

1301  
Extended  
Strike to suit  
1131 Latch  
(std +10mm)

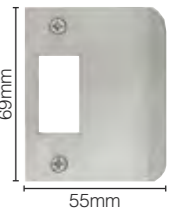

- > Includes anti-rattle tab

Finishes: ▽SS ▽PC

1151  
Strike and  
Recess Box



Finishes: ▽BN, SC ▽PC

Plate Options

All Longplates 233mm x 32mm x 10mm  
(Except Vulcan 233mm x 40mm x 10mm)

- > Suitable for aluminium joinery
- > Compatible with 30mm lock Backset (except Luna 35mm)
- > Hardware can be modified to suit other locking systems including oval profile Cylinder
- > Can be powder coated to match your joinery

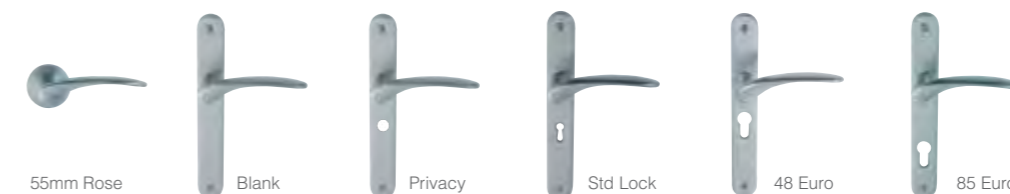

Dummy Handle  
Fixing Mounts

1152  
8mm Spindle  
32mm Ø base



1137  
7.6mm Spindle  
26mm Ø base



- > Dummy Mounts must be recessed 3mm into door when installing

- > Levers designed to National DDA standards. Suitable for use in retirement villages and public use buildings
- > Substantial return to the door at the end of the lever for ease of grip when operating the handle
- > Levers constructed with smooth radiused edges, no sharp corners
- > Short lever action for your convenience when opening the door
- > Suitable for interior or exterior applications
- > Through screws & grubscrew fixing to provide a firm fit to the door

# Door Furniture Futura

## Door Furniture > Streamline & Ellipse

**NEW** ELLIPSE  
by Windsor



PROFESSIONALSERIES

### Ellipse Lever

7330 Lever Set  
7331 Passage Set  
(includes 1172 Heavy Duty Latch)  
50mm Ø Rose



Lever Set  
178mm x 44mm x 8mm Plate

7338 Blank  
7338 E48 Euro (Pic)



7341  
Blank



7344  
Oval 64mm



7343  
Blank/Turn



7345  
Oval/Turn



7342  
Blank/Oval



- > Passage Set includes Heavy Duty 57mm Backset Tubular Latch
- > 304 grade tubular stainless steel
- > Strong solid stainless rose design - excellent for use with commercial mortice locks
- > Heavy Duty - exceeds 200,000 cycle test

Finishes: ▼SS ▼PC

### Ellipse Lever with Return

7332 Lever Set with return to door  
7333 Passage Set  
(includes 1172 Heavy Duty Latch)  
50mm Ø Rose



Lever Set  
178mm x 44mm x 8mm Plate

7339 Blank (Pic)  
7339 E48 Euro



7346  
Blank



7349  
Oval 64mm



7348  
Blank/Turn



7350  
Oval/Turn



7347  
Blank/Oval



- > Designed to National DDA standards
- > Suitable for use in retirement villages and public use buildings
- > Substantial return to the door at the end of the lever for ease of grip when operating the handle

Shown in Matt Black (PC)

### Turn & Release

7334 Turn & Release only  
7335 Turn & Release with 1173 Heavy Duty Bolt  
57mm b/s  
7337 Turn only with flat tail bar  
50mm Ø Rose



Finishes: ▼SS ▼PC

### Escutcheons

7336 E Euro (Pair)  
50mm Ø Roses  
7336 O Oval (Pair)  
50mm Ø Roses

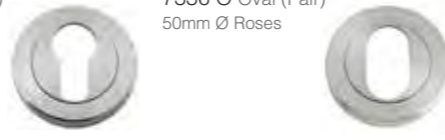

## STREAMLINE by Windsor

### Streamline Round Rose

7313 Lever Set  
7313D Dummy Lever - Single (LH or RH)  
7314 Passage Set  
7315 Privacy Set - inc. Auxiliary Bolt  
7316 Entrance Set  
7317 Privacy Set - Integrated  
54mm Ø Rose



Finishes: ▼BN, SC ▼PC

### Streamline Square Rose

7318 Lever Set  
7318D Dummy Lever - Single (LH or RH)  
7319 Passage Set  
7320 Privacy Set - inc. Auxiliary Bolt  
7321 Entrance Set  
7322 Privacy Set - Integrated  
54mm Square Rose



FUTURA  
by Windsor



LIFESTYLESERIES



^ 9023-BN

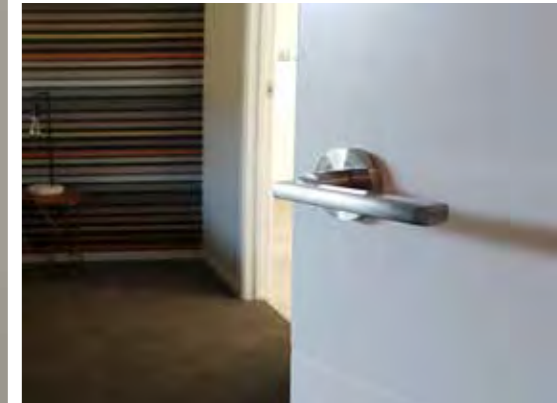

^ 9019-BN

Handing for Single/Dummy Handles

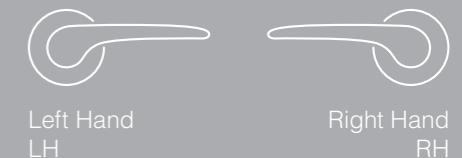

^ 9051-BLK

Door Furniture > Futura Elite Black

FUTURA  
by Windsor

- > All Futura Handle styles in black finish
- > Your 'Complete House Package' in black ex stock; from Doorstops to Flush Pulls
- > All Latch Faceplates & Striker Plates also supplied in black

**NEW** Apex Elite

- 9036 Lever Set
- 9036D Dummy Lever - Single (non handed)
- 9037 Passage Set
- 9038 Privacy Set (inc. Auxiliary Bolt)
- 9039 Locking Set
- 9055 Privacy Set - Integrated  
54mm Square Rose

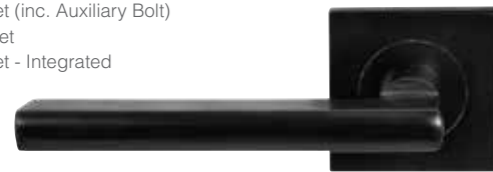

**NEW** Corbel Elite

- 9040 Lever Set
- 9040D Dummy Lever - Single (non handed)
- 9041 Passage Set
- 9042 Privacy Set (inc. Auxiliary Bolt)
- 9043 Locking Set
- 9056 Privacy Set - Integrated  
54mm Square Rose



Auxiliary Privacy Bolt

**NEW** 9044 Privacy Set

- > 60mm b/s Bolt
- > 54mm Square Rose
- > 5mm Spindle

9034 Privacy Set

- > 60mm b/s Bolt
- > 54mm Ø Rose
- > 5mm Spindle



9037-BLK

Cavity-Suite

**NEW** 5330 Passage Kit

- > Sliding Door Hardware
- > 65mm Square
- > 60mm b/s Bolt
- > Includes Door Edge Pull
- > Flush turn design
- > Easy installation

5326 Passage Kit

- > Sliding Door Hardware
- > 65mm Ø
- > 60mm b/s Bolt
- > Includes Door Edge Pull
- > Flush turn design
- > Easy installation

**NEW** 5331 Privacy Kit (Pic)

5327 Privacy Kit (Pic)



Finishes: ▀BLK



5318-BLK / 5333-BLK

- > Lever Set - includes Levers only.
  - > Passage Set - includes Levers and Futura 60mm Backset Latch.
  - > Dummy Lever - includes single Lever Handle and 1152 Dummy Mount.
  - > Privacy Set - includes Levers, Futura 60mm Backset Tubular Latch and Privacy Bolt, Turn and Escape.
  - > Locking Set - includes Levers, 1143 Euro Mortice Lock, Escutcheons and 1148 Euro Cylinder and Turn.
  - > Integrated Privacy Set - includes Levers and Futura 60mm Backset Tubular Privacy Latch.
- Ref Inside Back Cover for illustrations of combinations

Door Furniture > Futura Black

FUTURA  
by Windsor

Apex

- 9018 Lever Set
- 9018D Dummy Lever - Single (non handed)
- 9019 Passage Set
- 9020 Privacy Set (inc. Auxiliary Bolt)
- 9021 Locking Set
- 9051 Privacy Set - Integrated  
54mm Ø Rose



Talon

- 9026 Lever Set
- 9026D Dummy Lever - Single (LH or RH)
- 9027 Passage Set
- 9028 Privacy Set (inc. Auxiliary Bolt)
- 9029 Locking Set
- 9053 Privacy Set - Integrated  
54mm Ø Rose



Corbel

- 9022 Lever Set
- 9022D Dummy Lever - Single (non handed)
- 9023 Passage Set
- 9024 Privacy Set (inc. Auxiliary Bolt)
- 9025 Locking Set
- 9052 Privacy Set - Integrated  
54mm Ø Rose



Helix

- 9030 Lever Set
- 9030D Dummy Lever - Single (LH or RH)
- 9031 Passage Set
- 9032 Privacy Set (inc. Auxiliary Bolt)
- 9033 Locking Set
- 9054 Privacy Set - Integrated  
54mm Ø Rose



Sliding Door Hardware

Flush Pulls

- 5317 126mm x 42mm
- 5318 158mm x 42mm
- 5319 190mm x 42mm



Edge Pull

- NEW** 5333 Cavity Sliding Edge Pull 29mm x 29mm
- > 25mm hole pattern for install



Retrofit Adaptor Roses

**NEW** 9075 Press-on Integrated Privacy Adapter Rose (Pair)

9062 Screw-on Passage Rose (Pair)

- > 65mmØ x 10mm screw on adaptor plate for Futura Round Rose
- > Use for 54mm hole pattern
- > Suits Apex, Corbel & Helix (Talon n/a)



Apex Lever with 9062 fitted

Radius Hinge

- 5904 89mm x 60mm x 2.5mm ¼" Radius Corners
- > Stainless Steel material with Matt Black finish and black screws
- > Comes with 18mm screws, 25mm screws also available



Vulcan Stair Rail Brackets

- 5352 54mm Ø Rose (Showing flat mount adaptor)
- NEW** 5353 54mm Square Rose



- > Designed to match your door hardware and accessories
- > Suits Round or Square Rail (adaptor included)
- > Suits 40mm-50mm diameter rail
- > 4 Wall Fixing Points - Concealed Fixings
- > Design exceeds standard NZS/AS 1657:1992

Doorstops

- 5229 75mm x 30mm Skirting Mount
- 5240 85mm x 30mm Concealed Skirting Fix
- 5256 38mm x 38mm Floor Mount
- NEW** 5262 80mm x 19mm Square Skirting Mount



Finishes: ▀BLK



Door Furniture > Futura

FUTURA  
by Windsor

- > Recommended for interior use only
- > 54mm Square Concealed Fix Rose
- > Through Fixing and Grub Screws for added strength
- > Brushed Nickel finish to complement modern décor

Apex Elite

- 9036 Lever Set
- 9036D Dummy Lever - Single (non handed)
- 9037 Passage Set
- 9038 Privacy Set (inc. Auxiliary Bolt)
- 9039 Locking Set
- 9055 Privacy Set - Integrated  
54mm Square Rose

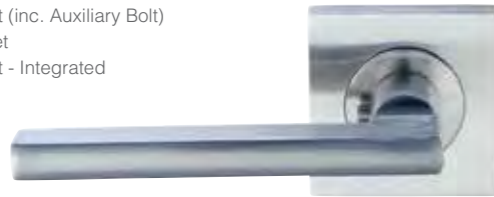

Finishes: ▽BN ▽PC

Corbel Elite

- 9040 Lever Set
- 9040D Dummy Lever - Single (non handed)
- 9041 Passage Set
- 9042 Privacy Set (inc. Auxiliary Bolt)
- 9043 Locking Set
- 9056 Privacy Set - Integrated  
54mm Square Rose



Auxiliary Privacy Bolt

- 9034  
60mm b/s Bolt  
54mm Ø Rose  
5mm Spindle



- 9044  
60mm b/s Bolt  
54mm Square Rose  
5mm Spindle



Finishes: ▽BN ▽PC

Four unique styles, one unbeatable price

- > Lever Set - includes Levers only.
- > Passage Set - includes Levers and Futura 60mm Backset Latch.
- > Dummy Lever - includes single Lever Handle and 1152 Dummy Mount.
- > Privacy Set - includes Levers, Futura 60mm Backset Tubular Latch and Privacy Bolt, Turn and Escape.
- > Integrated Privacy Set - includes Levers and Futura 60mm Backset Tubular Privacy Latch.
- > Locking Set - includes Levers, 1143 Euro Mortice Lock, Escutcheons and 1148 Euro Cylinder and Turn.  
Ref Inside Back Cover for illustrations of combinations

Door Furniture > Futura

FUTURA  
by Windsor

Apex

- 9018 Lever Set
- 9018D Dummy Lever - Single (non handed)
- 9019 Passage Set
- 9020 Privacy Set (inc. Auxiliary Bolt)
- 9021 Locking Set
- 9051 Privacy Set - Integrated (Pic)  
54mm Ø Rose



Talon

- 9026 Lever Set
- 9026D Dummy Lever - Single (LH or RH)
- 9027 Passage Set
- 9028 Privacy Set (inc. Auxiliary Bolt)
- 9029 Locking Set
- 9053 Privacy Set - Integrated  
54mm Ø Rose



Finishes: ▽BN ▽PC

Corbel

- 9022 Lever Set
- 9022D Dummy Lever - Single (non handed)
- 9023 Passage Set
- 9024 Privacy Set (inc. Auxiliary Bolt)
- 9025 Locking Set
- 9052 Privacy Set - Integrated  
54mm Ø Rose



Helix

- 9030 Lever Set
- 9030D Dummy Lever - Single (LH or RH)
- 9031 Passage Set
- 9032 Privacy Set (inc. Auxiliary Bolt)
- 9033 Locking Set
- 9054 Privacy Set - Integrated  
54mm Ø Rose



Accessories

Escutcheon

- 9035 (Pair)  
54mm Ø x 10mm Roses



- 9045 (Pair)  
54mm x 10mm  
Square Roses



Finishes: ▽BN, SC ▽PC

Integrated Privacy Latch

- 1358 60mm b/s
- 1359 70mm b/s (Pic)



Passage Latch

- 1357 60mm b/s
- 1101 70mm b/s

> Recommended Rebate Kit code 1102A - Ref page 98

Finishes: ▽BN, SC ▽PC

Retrofit Adaptor Roses

65mm Adaptor Roses available to suit Futura\* Push-on Rose and Integrated Privacy

- > Use with existing 54mm holes
- > 70mm Privacy Latch now available
- > Futura now offers an entire accessory package for 25mm-54mm hole, 60mm or 70mm Backset, with Passage & Privacy function
- > Press-on rose with grub screw for strong fixing - won't drop off when the door is slammed

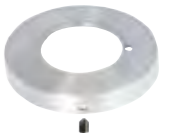

- NEW** 9075 Press-on Integrated Privacy Adaptor Rose, Pair (Pic)

- 9062 Screw-on Passage Rose, Pair

\*Suits Apex, Corbel & Helix (Talon n/a)

Finishes: ▽BN, SC ▽PC

^ Apex Lever with 9075 fitted

The Jura and Contract ranges offer a fantastic retro-fit option. Unique styling and economy pricing will also appeal to the entry level new house market.

Door Furniture > Jura & Contract



VALUESERIES

JURA  
by Windsor

CONTRACT  
by Windsor

Kona

- 9008 Passage Set
- 9009 Privacy Set - Integrated (Pic)
- 9010 Dummy Single - Fixed (non handed)



Alto

- 9005 Passage Set
- 9006 Privacy Set - Integrated
- 9007 Dummy Single - Fixed (non handed)



- > Adjustable 60mm-70mm b/s Latch
- > 65mm Ø Rose
- > Suits 54mm drill-out pattern

Finishes: ▣BN

Deadbolts

NEW Matt Black available ex stock

- 9011 Key/Key Suitable for door thicknesses 34mm to 46mm

- 9012 Key/Turn Suitable for door thicknesses 34mm to 50mm



- > Sold as complete units only
- > Adjustable bolt for 60mm or 70mm b/s
- > C4 key profile
- > Supplied with 3 keys
- > Concealed fix to exterior
- > 64mm Rose

Finishes: ▣BLK, SS ▣PC

- 9015 Lever Set (Pic) 120mm x 42mm plate
- 9017 Passage Set (9015 and 1100 latch)



RECOMMENDED FOR INTERIOR USE ONLY  
See Belmont range on page 31 for exterior options

Lever Set  
155mm x 42mm Plate

- 9013 Standard Keyhole (Pic)
- 9014 Blank Plate



- 9016 Locking Set (9013 and 1108 Lock, 57mm b/s, 78mm c/s)



Finishes: ▣BLK, BN

Door Accessories

Door Accessories > Door Catches, Magnets, Drill Bits, Hinges & Misc

Magnets and Drill Bits

Door Magnets

- 1180 25mm x 7mm (Pic)
- 1180-5 25mm x 7mm, 5pk
- 1262 22mm x 8mm (Pic)
- 1262-5 22mm x 8mm, 5pk
- 1265 25mm x 10mm



- > Bumpstop and screws supplied
- > Includes rubber buffers for a soft close
- > Made from N42 grade raw material for superior magnet strength

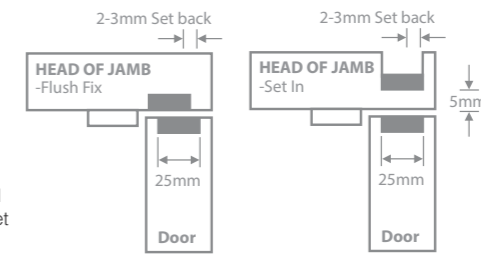

1180

- 1191 25mm Forstener Drill Bit
- 1278 22mm Forstener Drill Bit



- > For use with Windsor magnets
- > Drills a smooth clean hole
- > 25mm diameter, 9.5mm shank
- > The short narrow point won't protrude into jamb like a standard spade



- 1314 Door Buffer 8mm Ø
- > 20 pack
- > Drill-in style



- 1315 Bumpstop 8mm Ø
- > 20 pack
- > Self-adhesive



Door Catches

Roller Catch

- 1119



> "T" Striker included

Finishes: ▣AB, CP, PB

Double Ball Catch

- 5015 50mm



- 5016 60mm



Finishes: ▣PB, SC, UB  
▣AB, NB, OR, PC, SB

Hinges (other hinges available on request)

- 5901 Loose Pin Flat Tip
- 5903 Fixed Pin Flat Tip 101.6mm x 76.2mm Includes screws
- > Solid Stainless



- 5900 Loose Pin Ball Tip
- 5902 Fixed Pin Flat Tip 101.6mm x 76.2mm Includes screws
- > Solid Brass



Finishes: ▣SS ▣PC

- 5904 Loose Pin 89mm x 60mm 1/4" Radius Corners
- > Solid Stainless
- > Comes with 18mm screws, 25mm screws also available



▣BLK, GN, SS  
▣PC

Miscellaneous

- 1141 Adaptor Plates 65mm Ø (Pair)



Finishes: ▣PB, SS, UB  
▣AB, NB, PC, RB, SB

- 1167 Split Spindle 7.6mm x 98mm

- 1171 (Pic) Split Spindle 7.6mm x 116mm for 52mm+ doors



Wardrobe/Cupboard Options

Dummy Handle Fixing Mounts

- 1137 7.6mm Spindle 26mm Ø base



- 1152 8mm Spindle 32mm Ø base



Lever Option  
With dummy fixing mount



Cabinet Pull Options  
Use with one of the catches or magnets above. Through door rear fix.

See pages 69-77 for Cabinet Handles



Door Accessories > Doorstops



5240-GN

Doorstops

Floor Mount

5062  
Height 22mm



Finishes:  
 ▣ AB, BN, CP, PB, SC, UB  
 ▣ NB, OR, PC, RB, SB

5249  
38mm x 38mm  
2 Piece



▣ BN, SA  
 ▣ PC

5256  
38mm x 38mm



▣ BLK, BN, GN, SA  
 ▣ PC

5264  
60mm x 38mm



> 5249, 5274 & 5278 suitable for wooden & concrete floors

NEW Graphite Nickel & Matt Black available ex stock

5307  
90mm x 38mm



▣ BN, SA  
 ▣ PC

5274  
38mm x 38mm



> Complete with screw & dynabolt fix options

5278  
60mm x 38mm



Concealed Skirting Fix

5090  
73mm x 40mm



▣ AB, BN, CP, PB, SC, UB  
 ▣ NB, OR, PC, RB, SB

5229  
5299 3 pack  
75mm x 30mm



▣ BLK, BN, CP, PB, SC, PC-Bronze  
 ▣ PC

5262  
80mm x 19mm



NEW Graphite Nickel & Matt Black available ex stock

▣ BLK, BN, GN, SA  
 ▣ PC

5341 5342  
30mm x 30mm 50mm x 30mm



> Ideal for situations where a door opens flush against a cupboard or unit with minimal room for a stopper

▣ BN, SA ▣ PC

5240  
85mm x 30mm



NEW Graphite Nickel & Matt Black available ex stock

▣ AB, BLK, BN, CP, GN, PB, SA, UB  
 ▣ NB, OR, PC, RB, SB

5298 3 pack  
85mm x 30mm



▣ BLK, BN, SA

5265  
110mm x 30mm



▣ BN, SA  
 ▣ PC

Adjustable Angle Doorstop

5315  
110mm x 40mm

- > Perfect for doors next to side-lights or splayed skirtings
- > Adjust angle of doorstop to ensure it meets the door at 90°

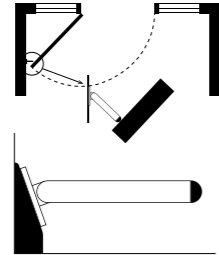

Finishes:  
 ▣ BN, SC  
 ▣ PC

Skirting Fix

5186  
87mm x 40mm

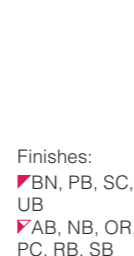

Finishes:  
 ▣ BN, PB, SC, UB  
 ▣ AB, NB, OR, PC, RB, SB

5230  
110mm x 38mm

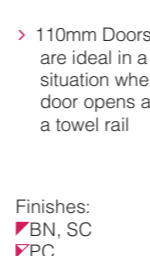

- > 110mm Doorstops are ideal in a situation where the door opens against a towel rail

Finishes:  
 ▣ BN, SC  
 ▣ PC

Door Accessories > Door Holders & Doorstops

Door Holders

5357  
Magnetic Doorstop  
50mm x 75mm



- > Wall or floor mount

Finishes: ▣ BN, SC ▣ PC

8067  
Engaged length 37mm  
Shown in AB



▣ AB, BN, PB, SC, UB  
 ▣ NB, OR, PC, RB, SB

5133  
Engaged length 88mm  
Shown in Appliance White (PC)



▣ AB, BLK, BN, PB, SC, UB  
 ▣ NB, OR, PC, RB, SB

5258  
Engaged length 93mm  
43mm Ø base



Powder Coat colours stocked; Silver Pearl, Desert Sand, Black, Ironsand, Arctic White, Sandstone Grey, Grey Friars, Karaka, Titania, Bronco, Off White  
 ▣ BN, SC ▣ PC

Pedestal Post Auto Door Holder

5316 (inc. 5133) - Pic  
5382 (post only)



Finishes: ▣ Silver Pearl Powder Coat ▣ PC

- > Architectural design with concealed welds
- > Great for latching back exterior doors where there is no wall fixing option available on concrete and timber decks and patios
- > Standard height 280mm, width 50mm x 50mm
- > Can be cut down on request
- > Base plate size 90mm x 90mm x 5mm with 4 x 8mm fixing holes

Pedestal Post Doorstop Holder

5325 (inc. 5258)



5133-OR

Foot Operated Door Holder

5063  
170mm x 34mm  
26mm throw



Finishes:  
 ▣ PB, SC, UB  
 ▣ AB, AF, NB, OR, RB, SB

Hinge Pin Adjustable Doorstop

5277



- > Operates from approx. 85° - 125° using threaded adjuster
- > Can be mounted on any of the door hinges

Finish as pictured

Overhead Doorstops

5263L  
157mm x 46mm



> 5263R-SS shown installed



5263R  
157mm x 46mm



- > Use on doors hung as shown
- > Screws to door head jamb
- > Angle of operation: Minimum 70°, Maximum 120°. This is dependent of position on door jamb

Finishes: ▣ SS ▣ PC



Flush Bolts

Straight Throw

5308 Heavy Duty  
151mm x 25mm  
12mm bolt  
18mm throw



5028  
149mm x 20mm  
11mm bolt  
15mm throw  
Shown in OR



5235 Economy  
152mm x 19mm  
11mm bolt  
18mm throw



BN, PB, SC, UB AB, NB, OR, PC, RB, SB

BN, PB, SC PC

Reverse Barrel Bolts

Straight Throw

5225  
150mm x 31mm  
9.6mm pin  
40mm throw



5226  
100mm x 25mm  
7.6mm pin  
35mm throw



AB, BN, PB, SC, UB NB, OR, PC, RB, SB  
Custom length option - please enquire

Necked Throw

5270  
125mm x 31mm  
5271 (Pic)  
150mm x 31mm



Necked Inward  
25mm throw  
20mm Offset

5272 (Pic)  
125mm x 31mm  
5273  
150mm x 31mm



Necked Outward  
25mm throw  
16mm Offset

- > Solid brass one piece extrusion
- > Heavy sprung ball bearing retention
- > Suitable for a large range of door types including bi-fold, sliding, hinged and rebated doors

Commercial Straight Bolt

5346 Socket bolt - standard throw  
5378 Socket bolt - with swivel  
150mm x 38mm

- > 12mm bolt provides great strength in commercial situations
- > Solid Brass construction, strong housing - built to last
- > Dual ball bearings provide a firm but smooth action
- > 30mm bolt throw

Finishes: BN, PB, SC, UB AB, NB, OR, PC, RB, SB



Shown in SC

Shown in BN

Door Accessories > Barrel Bolts

Straight Barrel Bolts (Front keepers included)

NEW 35mm size option  
AB, BLK & BN finishes available ex stock

- 5215 35mm x 25mm, 15mm throw
- 5207 50mm x 25mm, 20mm throw
- 5208 75mm x 25mm, 20mm throw
- 5209 100mm x 25mm, 20mm throw
- 5210 150mm x 31mm, long throw (50mm)
- 5224 150mm x 31mm, standard throw (30mm)



Shown in CP

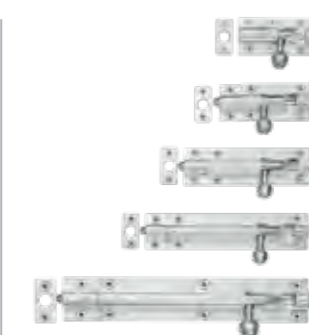

Shown in SC



Shown in BN



5208-CP



Shown in BLK



Shown in AB



Shown in PB

Necked Barrel Bolts (Front keepers included)

NEW AB, BLK & BN finishes available ex stock

- 5211 50mm x 25mm, 11mm throw
- 5212 75mm x 25mm, 19mm throw
- 5213 100mm x 25mm, 19mm throw
- 5214 150mm x 31mm, 25mm throw

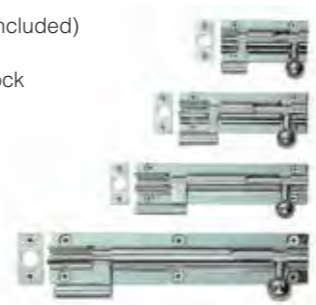

Shown in CP



Shown in SC

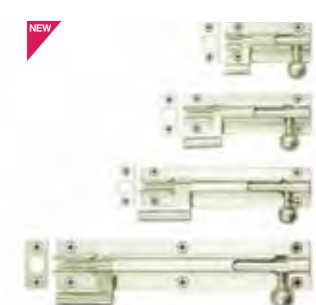

Shown in BN



Shown in BLK



Shown in AB



Shown in PB

Finishes:  
AB, BLK, BN, CP, PB, SC, UB  
NB, OR, PC, RB, SB  
5210 - CP, PB, SC ONLY

# Privacy and Sliding Door

## Door Accessories > Escutcheons, Cabin Hooks & Knockers

### Escutcheons

5135 Single  
34mm Ø



5051 Single  
34mm Ø



Finishes: ▣AB, BN, PB, SC, UB  
▣NB, OR, PC, RB, SB

Standard Lock 8003 Pair (Pic)  
45mm x 10mm

Euro 8003 E Pair (Pic)  
45mm x 10mm

Oval 8003 O Pair  
45mm x 10mm



Finishes: ▣AB, BN, PB, SC, UB  
▣NB, OR, PC, RB, SB

Euro 7020 E Pair (Pic)  
55mm Ø x 11mm

Oval 7020 O Pair  
55mm Ø x 11mm



Euro 8102E Pair  
55mm Square x 11mm

Oval 8102O Pair (Pic)  
55mm Square x 11mm



Finishes: ▣BN, SC ▣PC

**NEW** Euro 8189 Pair  
50mm Ø x 8mm Rose

Finishes: ▣BN, PB, SC, UB  
▣AB, NB, OR, PC, RB, SB



Euro 9035 Round Pair  
54mm Ø x 10mm

Euro 9045 Square Pair (Pic)  
54mm x 54mm x 10mm



Finishes: ▣BLK, BN, GN, MC, SC  
▣PC

Euro 8146 E Pair  
60mm x 30mm



Finishes: ▣BN, PB, SC  
▣AB, NB, OR, RB

### Cabin Hooks

5144 75mm - Engaged Opening 95mm



Shown in AB

5142 100mm - Engaged Opening 120mm



Shown in SC

5057 125mm - Engaged Opening 145mm



Shown in PB

5143 150mm - Engaged Opening 185mm



Shown in AB

5275 200mm - Engaged Opening 235mm



Shown in PB

5276 250mm - Engaged Opening 290mm



Shown in SC

Finishes: ▣PB, SC, UB  
▣AB, NB, OR, PC, RB, SB

### Door Viewer

5243 180° Door Viewer  
Suits 34mm-52mm doors



Finishes: ▣BN, PB, SC, UB  
▣AB, NB, OR, PC, RB, SB

### Knockers

3034  
210mm x 95mm



4016  
205mm x 100mm



Finishes: ▣PB, SC, UB  
▣AB, NB, OR, PC, RB, SB

### Brass Pull Handles

5038 235mm x 45mm

5039 235mm x 45mm



Finishes: ▣PB, UB  
▣AB, NB, OR, PC, RB, SB

### Push Plate

5059  
205mm x 50mm



Finishes: ▣PB, SC, UB  
▣AB, NB, OR, PC, RB, SB

## Privacy & Sliding Door > Double Turn & Privacy Hardware

### **NEW** Double Turn Mini Lever Sets

9076 54mm Ø Roses  
8mm Spindle



9077 54mm Square Roses  
8mm Spindle



Finishes: ▣BLK, BN, GN, SC ▣PC Shown in GN

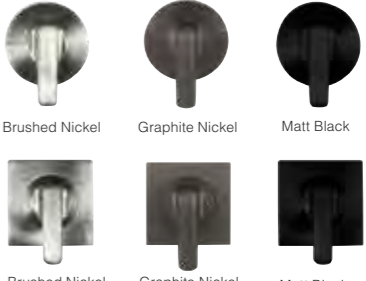

Brushed Nickel Graphite Nickel Matt Black  
Brushed Nickel Graphite Nickel Matt Black

### Double Turn Sets

8118  
46mm Ø Roses  
8mm Spindle



Finishes: ▣BN, SC ▣PC

**NEW** Graphite Nickel & Matt Black available ex stock

9072  
54mm Ø Roses  
8mm Spindle



Finishes: ▣BLK, BN, GN, SC ▣PC

**NEW** Graphite Nickel & Matt Black available ex stock

9073  
54mm Square  
Roses  
8mm Spindle



Finishes: ▣BLK, BN, GN, SC ▣PC

8147  
60mm x 30mm Roses  
8mm Spindle



Finishes: ▣BN, SC ▣PC

5199  
26.5mm Ø Roses  
5mm - 7.6mm  
Stepped Spindle



Finishes: ▣PB, SC, UB  
▣AB, NB, OR, PC, RB, SB

### Privacy Sets (Bolt included)

**NEW** Graphite Nickel & Matt Chrome available ex stock

7032 60mm b/s Bolt  
54mm Ø Roses  
5mm Spindle



Finishes: ▣BN, GN, MC, SC ▣PC

7072 60mm b/s Bolt  
55mm Ø Roses  
5mm Spindle



8101 60mm b/s Bolt  
55mm Square Roses  
5mm Spindle



Finishes: ▣BN, SC ▣PC

7076 Indicator 60mm b/s Bolt  
52.5mm Ø Roses  
5mm Spindle



Finishes: ▣SS

9034 60mm b/s Bolt  
54mm Ø Roses  
5mm Spindle



Finishes: ▣BLK, BN

**NEW** Graphite Nickel, Matt Black & Matt Chrome available ex stock

9044 60mm b/s Bolt  
54mm Square Roses  
5mm Spindle



Finishes: ▣BLK, BN, GN, MC ▣PC

5198 60mm b/s Bolt  
26.5mm Ø Roses  
5mm Spindle



8089 60mm b/s Bolt  
50mm Ø Roses  
5mm Spindle



Finishes: ▣AB, BN, PB, SC, UB ▣NB, OR, PC, RB, SB



Privacy & Sliding Door > Privacy Hardware

1 complete range, 2 designer styles,  
5 applications, infinite value

Privacy & Sliding Door > Sliding Door Hardware - Cavity-Suite

CAVITY-SUITE  
by Windsor

- > Suits door thicknesses from 32mm-42mm
- > Stainless Steel finish to complement Brushed Nickel and Satin Chrome
- > Flush turn design allows door to slide right back into cavity
- > Back to back Flush Pulls for quick and easy installation
- > Installation templates supplied

Turn & Escape

8055  
5mm Spindle



Finishes:  
 ▣ AB, BN, PB, SC, UB  
 ▣ NB, OR, PC, RB, SB



^ 8131-BN Privacy / 8055-BN

Indicator Turns

8041  
5mm Spindle



8042  
50mm Ø Roses  
5mm Spindle



Finishes:  
 ▣ PB, SC, UB  
 ▣ AB, NB, OR, PC, RB, SB

Single Turns For use with commercial Mortice Locks

7067  
55mm Ø Rose



Finishes: ▣ BN, SC  
 ▣ PC

8113  
55mm Square Rose



8104  
45mm Ø Rose



Finishes: ▣ BN, PB, SC, UB  
 ▣ AB, NB, OR, PC, RB, SB

Turn & Escape on Rose  
(Bolt not included)

7071  
55mm Ø Roses  
5mm Spindle



Finishes: ▣ BN, SC  
 ▣ PC

5192  
26.5mm Ø Roses  
5mm Spindle



8188  
50mm Ø Roses  
5mm Spindle



Finishes: ▣ BN, PB, SC, UB  
 ▣ AB, NB, OR, PC, RB, SB

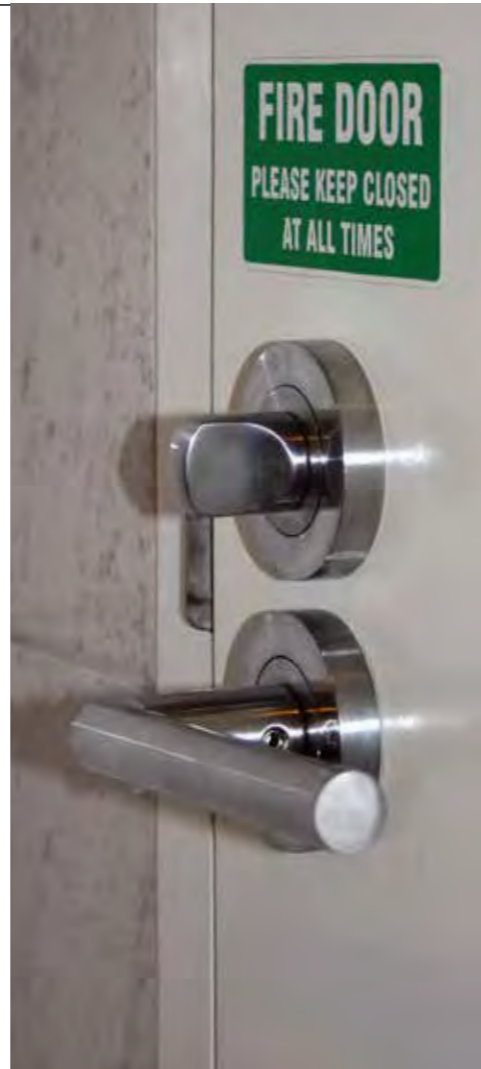

^ 8091-SC / 7067-SC

Round

5329 Cavity Sliding Edge Pull  
29mm Ø  
25mm hole pattern for install



NEW Graphite Nickel & Matt Black available ex stock

Finishes: ▣ BLK, GN, SS ▣ PC

Wardrobe

5339 Wardrobe Kit  
65mm Ø



Finishes: ▣ SS ▣ PC

Passage

5326 Cavity Sliding Passage Kit  
65mm Ø



NEW Graphite Nickel available ex stock

Finishes: ▣ BLK, GN, SS ▣ PC

Privacy

5327 Cavity Sliding Privacy Kit  
65mm Ø



NEW Graphite Nickel available ex stock

> Use on Bathroom doors

Finishes: ▣ BLK, GN, SS ▣ PC

Latching

5328 Cavity Sliding Double Turn  
60mm b/s Bolt



> Use on interconnecting rooms  
 Finishes: ▣ SS ▣ PC

Locking

5335 Cavity Sliding Locking Kit  
65mm Ø  
50mm b/s



Finishes: ▣ SS ▣ PC

Square

5333 Cavity Sliding Edge Pull  
29mm x 29mm  
25mm hole pattern for install



NEW Graphite Nickel & Matt Black available ex stock

Finishes: ▣ BLK, GN, SS ▣ PC

Wardrobe

5340 Wardrobe Kit  
65mm Square



Finishes: ▣ SS ▣ PC

Passage

5330 Cavity Sliding Passage Kit  
65mm Square



NEW Graphite Nickel & Matt Black available ex stock

Finishes: ▣ BLK, GN, SS ▣ PC

Privacy

5331 Cavity Sliding Privacy Kit  
65mm Square



NEW Graphite Nickel & Matt Black available ex stock

> Use on Bathroom doors

Finishes: ▣ BLK, GN, SS ▣ PC

Latching

5332 Cavity Sliding Double Turn  
60mm b/s Bolt



> Use on interconnecting rooms  
 Finishes: ▣ SS ▣ PC

Locking

5336 Cavity Sliding Locking Kit  
65mm Square  
50mm b/s



Finishes: ▣ SS ▣ PC



Privacy & Sliding Door > Sliding Door Hardware - Italian

For Flush Pull cropping dimensions, please refer to website.

Brass Flush Pulls

- 8088 Door Edge Pull  
29mm Ø  
24mm hole pattern for install
- 8141 Flush Pull (Single)  
120mm x 34mm
- 8079 Sliding Door Kit  
120mm x 34mm



- AB, BN, PB, SC, UB
- BB, BHB, MAB, MB, NB, OR, PC, RB, VB

- 8105 Flush Pull (Single)  
55mm x 11mm



- 8107 Flush Pull Kit  
29mm Ø Edge Pull  
55mm x 11mm Flush Pull



- 8106 Privacy Kit  
> Includes: Turn, Escape, Edge Pull and 50mm b/s Privacy Mortice Lock



- > Suits 36+mm doors
- > Countersunk Flush Pulls allow doors to fully recess inside cavity

- Finishes: BN, SC, PB
- PC

8079-AB

Privacy & Sliding Door > Sliding Door Hardware - Flush Pulls & Flush Rings

For Flush Pull cropping dimensions, please refer to website.

Flush Pulls

- 5317 Single Concealed Fix (Pic)
- 5317-BB Back to Back Fixing Pair  
126mm x 42mm, 96mm crs



- 5318 Single Concealed Fix (Pic)
- 5318-BB Back to Back Fixing Pair  
158mm x 42mm, 128mm crs



- 5319 Single Concealed Fix (Pic)
- 5319-BB Back to Back Fixing Pair  
190mm x 42mm, 160mm crs



> Back to back Flush Pulls suit door thicknesses from 32mm to 38mm

- Finishes: BLK, BN, GN, MC, SC
- PC
- > Back to back sets only available in BN, SC & PC

- 5363 Single Concealed Fix  
254mm x 42mm



- 5364 Single Concealed Fix  
318mm x 42mm



- BN, SC
- PC

- 5040  
125mm x 45mm

> Solid Brass



- Finishes: AB, PB, SC, UB
- NB, OR, PC, RB, SB

- 5228  
120mm x 40mm



- SS
- PC

- 5257 Concealed Fix  
128mm x 83mm

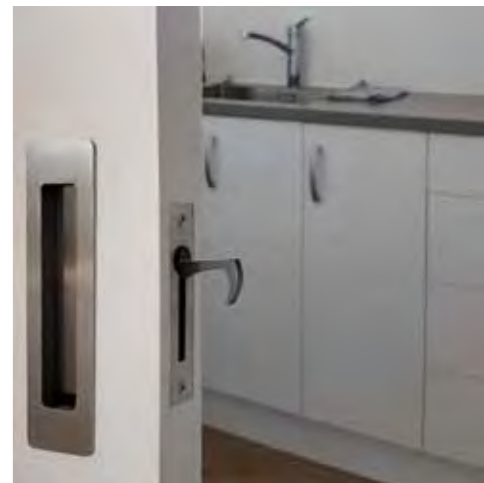

5318-BN / 5259-SS

Flush Rings

- 5177  
40mm x 33mm



- 5154  
50mm x 37mm



- 5155  
63mm x 50mm



- Finishes: AB, PB, SC, UB
- NB, OR, PC, RB, SB

Edge Pulls

- 5267 Oval Style  
100mm x 20mm



- SS
- PC

- 5259 Square Style  
100mm x 20mm



- 5309 Square Style  
25mm x 25mm



- BN, SC
- PC

Privacy & Sliding Door > Sliding Door Hardware - Flush Pulls & Lock Kits

For Flush Pull cropping dimensions, please refer to website.

Flush Pulls, Stainless Concealed Fix



^ 5321-SS

Flush Pull Kits

All Kits include 2 Flush Pulls & 100mm x 20mm Edge Pull.



^ 5260 Pictured

Euro Lock Kits

All Kits include 1179 Sliding Door Lock, 38mm Euro Cylinder, 2 Euro punched Flush Pulls & 100mm x 20mm Edge Pull.



^ 1188 Pictured

> Minimum door thickness 40mm

Finishes: ▽SS ▽PC

# Window Fittings & Hooks

Window Fittings & Hooks > Window Stays

Stays



> Ideal for use on windows to restrict opening to meet building standard

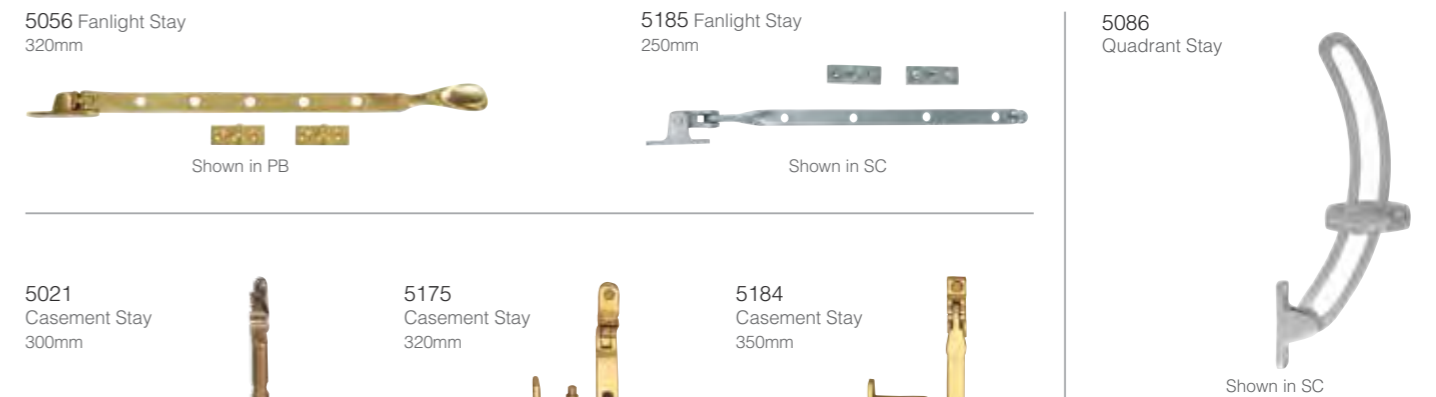

Finishes: ▽AB, BN, CP, PB, SC, UB  
▽NB, OR, PC, RB, SB



5021-BN Run Out

Finishes: ▽AB, BN, PB, SC, UB  
▽NB, OR, PC, RB, SB

5268 6mm Packer

To suit hardware being fitted to new timber windows with rubber draught seals.



For 5184, 5185 Casement & Fanlight Stays

Window Fittings & Hooks > Window Fasteners & Spring Catches

Window Fasteners

5343 Qube Window Fastener

> Narrow 31mm overall protrusion enables this Fastener to fit behind vertical blinds and wooden louvers



> Suits timber windows with or without weather seals

Finishes: ▣BN, SC, UB ▣AB, NB, OR, PB, PC, RB, SB

5344 Vulcan Window Fastener  
Shown in RB

> 44mm overall protrusion



5323 Wedge Fastener



> Suitable for use with weather seals

▣BN, PB, SC, UB ▣AB, NB, OR, PC, RB, SB

5324 Casement Fastener

5324-WS Casement Fastener  
to suit weather seals



5136 Teardrop Casement Fastener



▣PB, SC, UB  
▣AB, NB, OR, PC, RB, SB

5187 Square Casement Fastener



▣BN, PB, SC, UB  
▣AB, NB, OR, PC, RB, SB

5195 L Split Rail Fastener  
5195 R Split Rail Fastener  
Wedge Fastener



> Not suitable where weather seals are used

LH

RH

Spring Catches

5194 Standard 5361 300mm 5362 450mm Custom

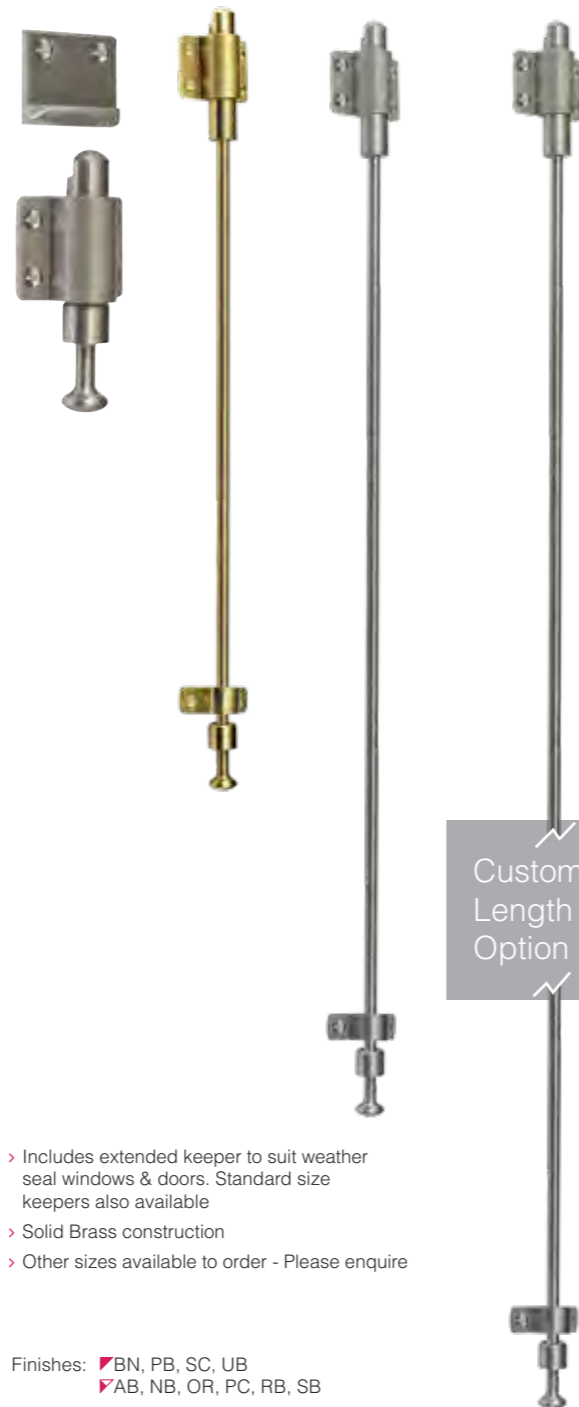

> Includes extended keeper to suit weather seal windows & doors. Standard size keepers also available  
> Solid Brass construction  
> Other sizes available to order - Please enquire

Finishes: ▣BN, PB, SC, UB  
▣AB, NB, OR, PC, RB, SB

Window Fittings & Hooks > Hooks, Sash Lifts & Pulls

Hooks - Hat, Coat & Robe

5250  
5297 3 pack  
Aluminium

> 3 packs available only in BN & SA



Finishes:  
▣BN, SA  
▣PC

5196



Shown in PB

▣PB, SC, UB  
▣AB, NB, OR, PC, RB, SB

5236



Shown in SC

3024  
110mm x 31mm



Shown in PB

4032 Triple Hook

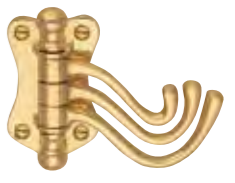

Shown in PB

▣PB, SC, UB  
▣AB, NB, OR, PC, RB, SB

Sash Fasteners

5025 Sash Fastener



Shown in AB

> Narrow 15mm profile keeper

▣BN, CP, PB, SC, UB ▣AB, NB, OR, PC, RB, SB

5060 Spur Fastener

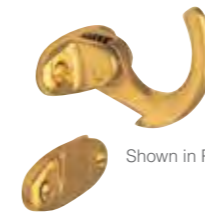

Shown in PB

5269 6mm Packer



For 5060 spur fastener

> To suit hardware being fitted to new timber windows with rubber draught seals.



5250-SA

Sash Lifts

5026 Hook  
50mm x 25mm  
30mm pj



Shown in AB

Finishes: ▣BN, CP, PB, SC, UB  
▣AB, NB, OR, PC, RB, SB

5053  
40mm x 15mm  
30mm pj



Shown in AB

5360 Hook  
39mm x 12mm  
23mm pj



Shown in PB

▣BN, PB, SC, UB  
▣AB, NB, OR, PC, RB, SB

Pulls

5190  
100mm o/a, 86 mm crs



Shown in PB

▣BN, PB, SC, UB ▣AB, NB, OR, PC, RB, SB

5191  
125mm o/a, 111 mm crs



Shown in SC

Pulley

5197  
122mm x 25mm



Shown in SC

▣PB, SC, UB  
▣AB, NB, OR, PC, RB, SB

Cleat Hook

5092  
76mm x 23mm



Shown in PB

▣PB, SC, UB  
▣AB, NB, OR, PC, RB, SB

Custom Length Option



# Bannister Brackets

# Cabinet Handles

## Bannister Brackets & Stanchions

Quality, style and functionality are seen in the Windsor range of Bannister Brackets.

- > Made from solid brass
- > Strong, concealed fixing
- > Simple lag screw that can be used with narrow gauged timber framing
- > Quick and easy to install - simply drill a 5mm hole and wind them in
- > Can be supplied with face fixing option

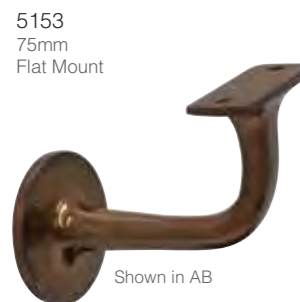

Finishes: ▶ AB, BN, PB, SC, UB  
▶ NB, OR, PC, RB, SB

These solid Vulcan/Sigma inspired Stair Rail Brackets have been designed with your internal door hardware in mind.

- > Curved and flat mount options included with each bracket (see diagram below)
- > Suits 40mm-50mm diameter rail
- > Easy install with concealed fittings
- > Design complies with clearances specified in standard NZS/AS 1657:1992

▶ NEW Graphite Nickel, Matt Black & Matt Chrome available ex stock

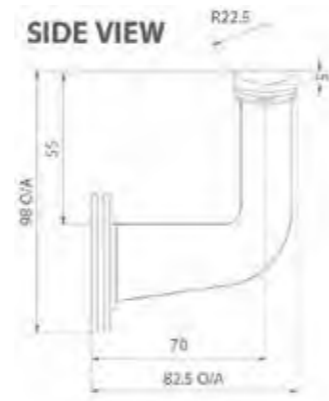

Finishes: ▶ BLK, BN, GN, MC, SC  
▶ PC

Strong, solid and aesthetically appealing, these matching Bannister Stanchions are made from a one piece brass casting, giving quality, economy and style to add that extra touch.



Finishes: ▶ AB, PB, SC, UB  
▶ NB, OR, PC, RB, SB



^ 5352-BN



^ Streamline GN



^ Marco BN



^ Minerva GN

### Abbreviations

- crs - screw centres
- o/a - overall length
- pj - projection

# Cabinet Handles

## Cabinet Handles > Lifestyle Series

### Minerva 15mm wide, 34mm projection

6413 96mm crs, 126mm o/a  
6314 128mm crs, 158mm o/a  
6414 160mm crs, 190mm o/a  
6315 192mm crs, 222mm o/a  
6316 288mm crs, 318mm o/a  
6415 448mm crs, 478mm o/a

Finishes: ▼BN, SA ▼PC

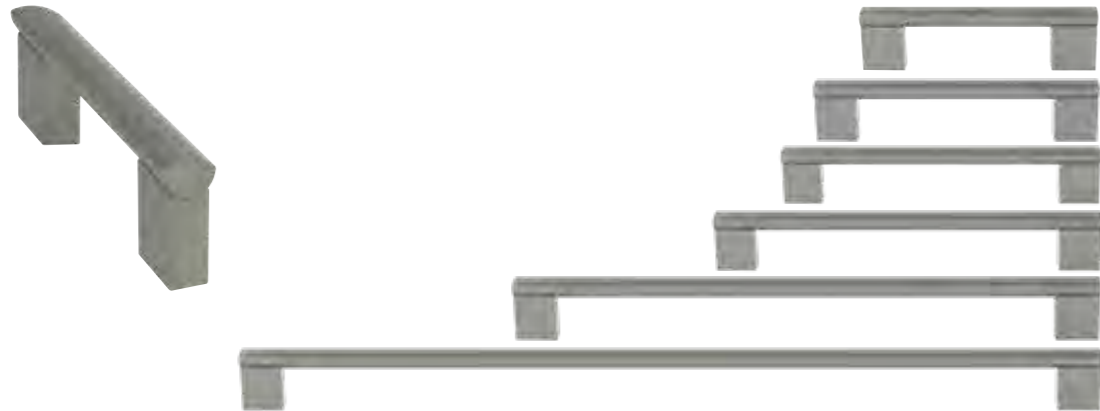

- > Three finishes, two designer styles, one fantastic price per size
- > New Graphite Nickel finish matches modern colour themes in kitchens
- > Styles to suit the latest cabinet trends and appliance designs
- > Coordinate with your door furniture and accessories

## Cabinet Handles > Lifestyle Series

### Streamline 19mm wide, 32mm projection

6484 128mm crs, 142mm o/a  
6485 160mm crs, 174mm o/a  
6487 256mm crs, 270mm o/a  
6489 320mm crs, 334mm o/a  
6490 448mm crs, 462mm o/a  
6491 640mm crs, 654mm o/a

Finish: ▼BN ▼PC



6413 96mm crs, 126mm o/a  
6314 128mm crs, 158mm o/a  
6414 160mm crs, 190mm o/a  
6315 192mm crs, 222mm o/a  
6316 288mm crs, 318mm o/a  
6415 448mm crs, 478mm o/a

Finish: ▼GN

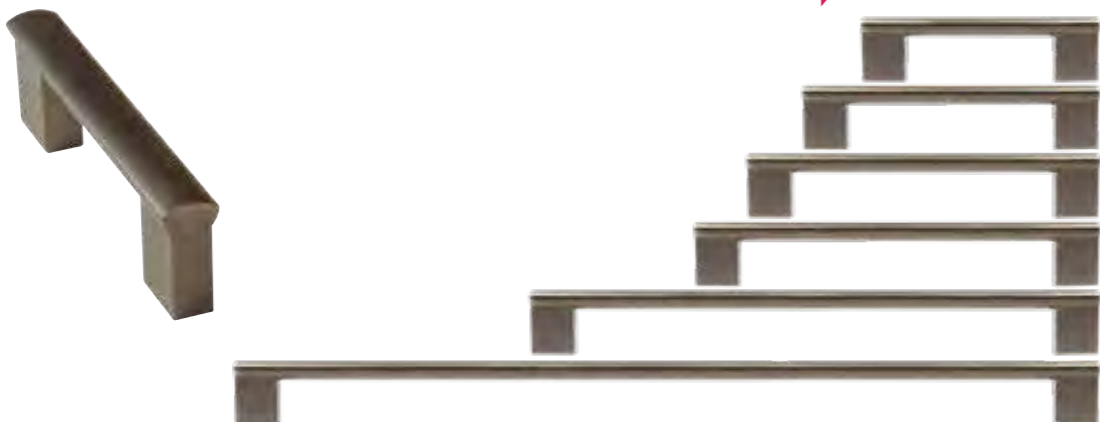

NEW Graphite Nickel available ex stock

6484 128mm crs, 142mm o/a  
6485 160mm crs, 174mm o/a  
6487 256mm crs, 270mm o/a  
6489 320mm crs, 334mm o/a  
6490 448mm crs, 462mm o/a

Finish: ▼GN

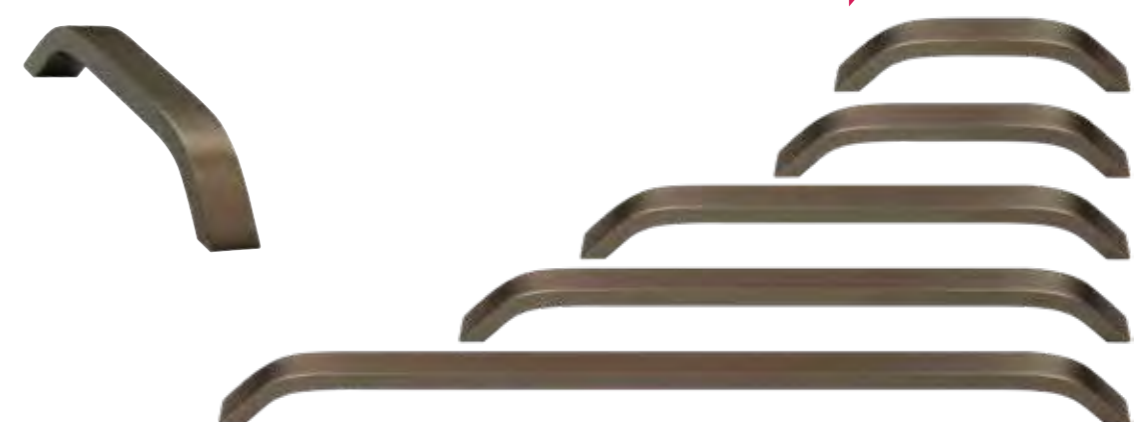

NEW Graphite Nickel available ex stock

6413 96mm crs, 126mm o/a  
6314 128mm crs, 158mm o/a  
6414 160mm crs, 190mm o/a  
6315 192mm crs, 222mm o/a  
6316 288mm crs, 318mm o/a  
6415 448mm crs, 478mm o/a

Finish: ▼BLK

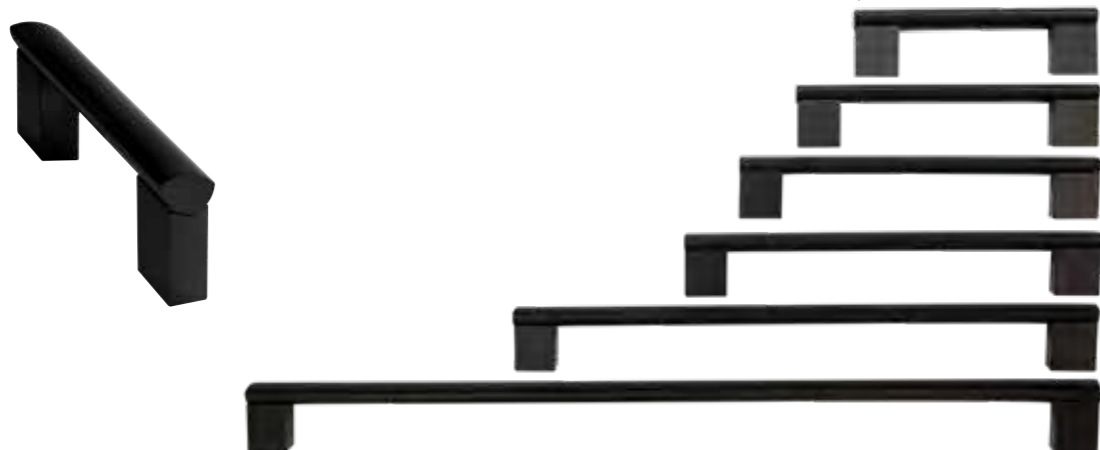

NEW Matt Black available ex stock

6484 128mm crs, 142mm o/a  
6485 160mm crs, 174mm o/a  
6487 256mm crs, 270mm o/a  
6489 320mm crs, 334mm o/a  
6490 448mm crs, 462mm o/a

Finish: ▼BLK

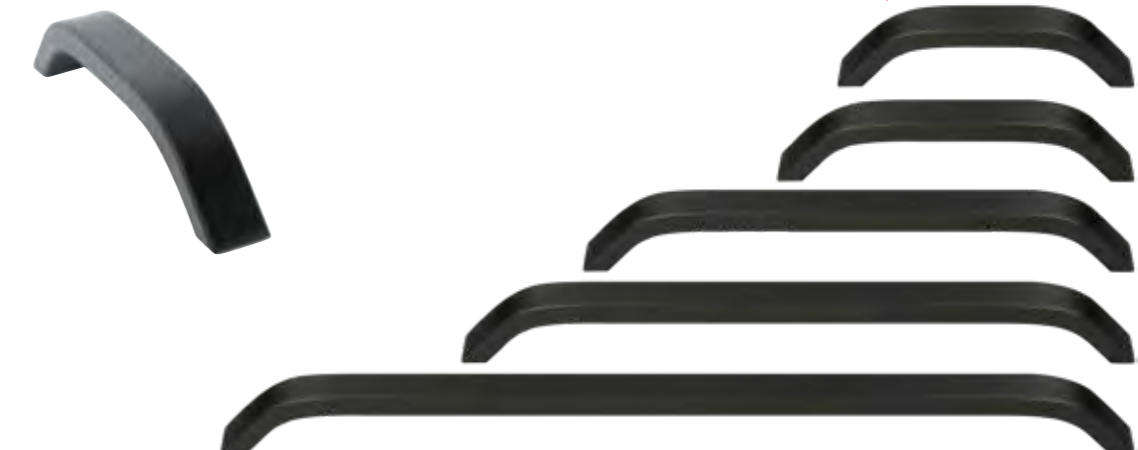

NEW Matt Black available ex stock



Styles to suit the latest cabinet trends and appliance designs

## Cabinet Handles Lifestyle Series

### Pakello 10mm wide, 32mm projection

6434 128mm crs, 177mm o/a  
6435 160mm crs, 209mm o/a  
6436 192mm crs, 241mm o/a  
6437 288mm crs, 337mm o/a  
6438 448mm crs, 497mm o/a  
6439 640mm crs, 689mm o/a

Finishes: ▼BN ▼PC

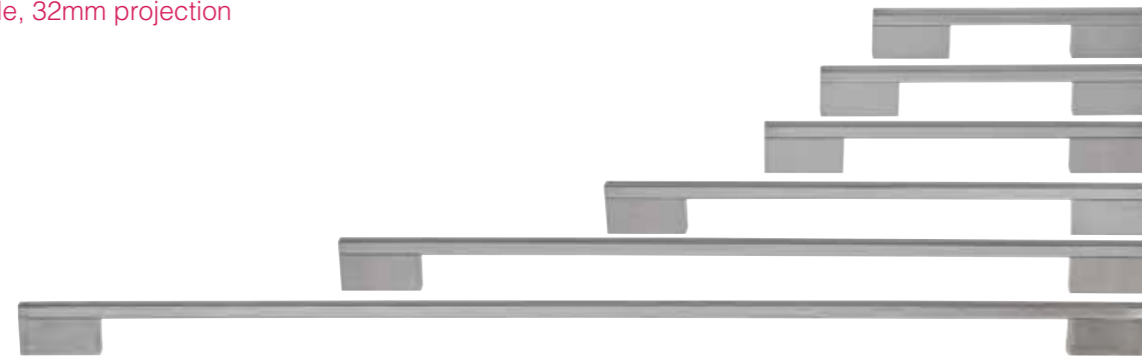

### Loreto 10mm diameter, 36mm projection

6074 128mm crs, 148mm o/a  
6500 160mm crs, 180mm o/a  
6075 192mm crs, 212mm o/a  
6076 320mm crs, 340mm o/a  
6501 448mm crs, 468mm o/a

Finishes: ▼BN

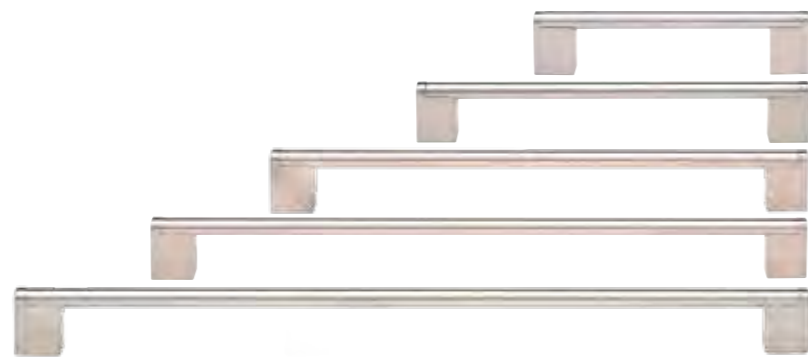

### Mitred D Handle 12mm diameter, 30mm projection

6071 96mm crs, 108mm o/a  
6497 128mm crs, 140mm o/a  
6072 160mm crs, 172mm o/a  
6498 192mm crs, 204mm o/a  
6073 288mm crs, 300mm o/a  
6499 448mm crs, 460mm o/a

Finishes: ▼SS ▼PC

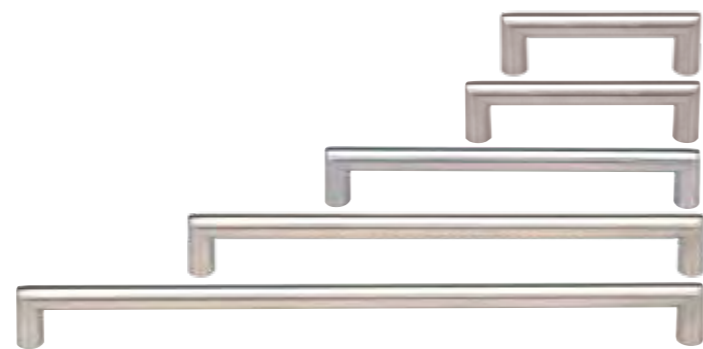

### Verbano Series II 11mm wide, 20mm projection

6492 64mm crs, 88mm o/a  
6493 128mm crs, 152mm o/a  
6494 192mm crs, 216mm o/a  
6495 288mm crs, 312mm o/a  
6496 448mm crs, 472mm o/a

Finishes: ▼BN ▼PC



## Cabinet Handles > Designer

### Melo 25mm wide, 32mm projection

6426 128mm crs, 144mm o/a  
6427 160mm crs, 176mm o/a  
6428 192mm crs, 208mm o/a  
6429 288mm crs, 304mm o/a  
6430 448mm crs, 464mm o/a  
6431 640mm crs, 656mm o/a

Finishes: ▼BN ▼PC

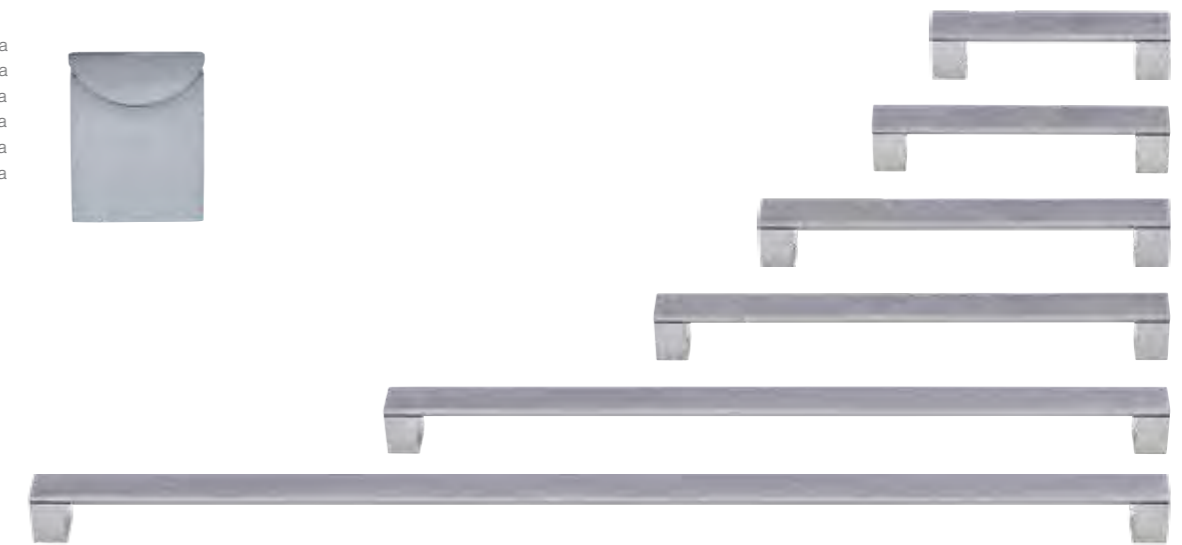

### Marco 8mm wide, 25.5mm projection

6336 96mm crs, 122mm o/a  
6337 128mm crs, 157mm o/a  
6338 160mm crs, 193mm o/a  
6339 192mm crs, 225mm o/a  
6340 240mm crs, 273mm o/a  
6382 320mm crs, 356mm o/a, 28mm pj

Finishes: ▼BN ▼PC

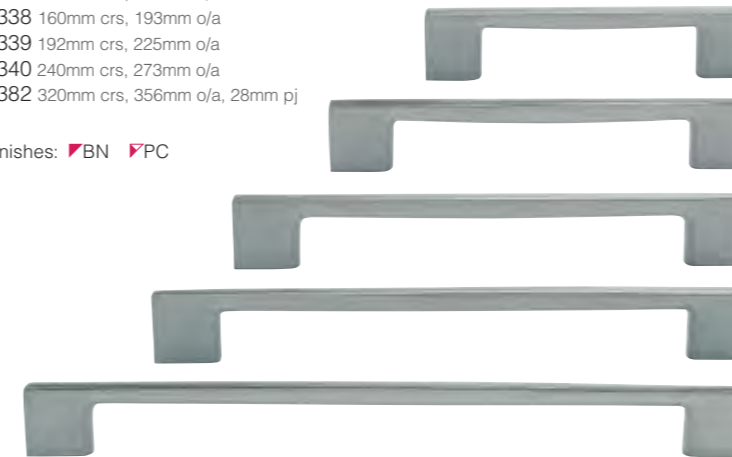

^ Verbano Series II BN



^ Marco BN



Cabinet Handles > Designer



Minerva GN

Polo 25mm projection

6333 128mm crs, 158mm o/a, 19mm wide



6334 160mm crs, 192mm o/a, 21mm wide



6335 192mm crs, 226mm o/a, 24mm wide



Finishes: ▼BN ▼PC

Rialto

6341  
39mm x 21mm  
16mm crs  
20mm pj



Finishes: ▼BN, SC ▼PC

Anglo

6345  
25mm x 25mm  
16mm crs  
21mm pj



Finishes: ▼BN ▼PC

Sincro 12mm wide, 27mm projection

6068 96mm crs, 104mm o/a  
6069 128mm crs, 136mm o/a  
6749 160mm crs, 168mm o/a  
6750 256mm crs, 264mm o/a  
6751 320mm crs, 328mm o/a

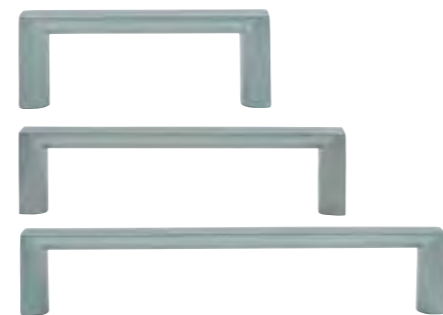

Finishes: ▼BN ▼PC

Streamline BLK

Cabinet Handles

Lecco

6077  
128mm crs  
146mm o/a  
20mm wide  
28mm pj



Finishes: ▼SA ▼PC

6108  
160mm crs  
193mm o/a  
34mm pj



Finishes: ▼BN ▼PC

6106  
96mm crs  
130mm o/a  
28mm pj



6107  
128mm crs  
162mm o/a  
28mm pj



Finishes: ▼BN ▼PC

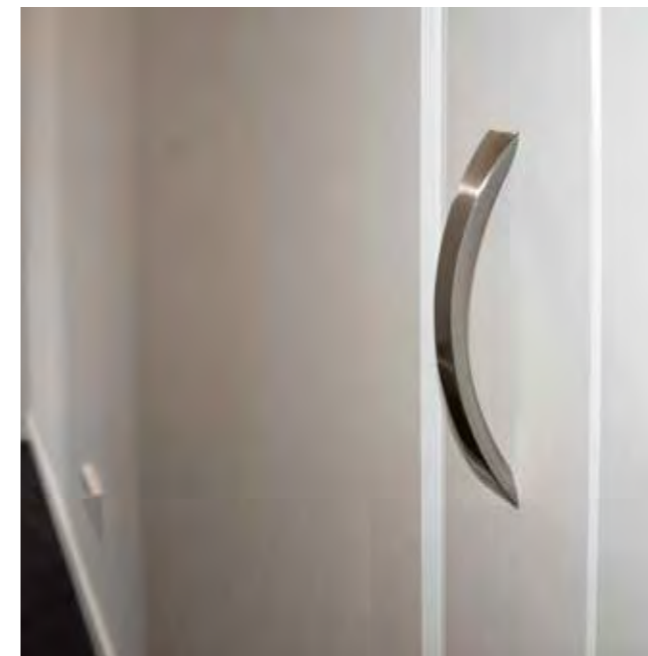

6108-BN

Primo

6357  
96mm crs  
123mm o/a



6358  
128mm crs  
161mm o/a



Finishes: ▼BN ▼PC

Bow Handles

6024  
96mm crs  
30mm pj



6029  
128mm crs  
31mm pj



Finishes: ▼SC ▼PC

Slimline Bow Handles

6038  
96mm crs  
110mm o/a  
22mm pj



6039  
128mm crs  
158mm o/a  
29mm pj



Finishes: ▼BN ▼PC

D-Handles 34mm projection

6002  
96mm x 8mm  
6006  
96mm x 10mm  
6019  
160mm x 10mm  
6010  
192mm x 10mm



Finishes: ▼SC ▼PC

Cabinet Handles > Empire

Magma

8307  
160mm crs  
187mm o/a  
30mm pj



Shown in OR



Shown in BN

Finishes: ▣BN, UB  
▣AB, NB, OR, PB, PC, RB, SB

Deco

8315  
96mm crs  
105mm o/a  
30mm pj



8316  
128mm crs  
137mm o/a  
30mm pj



8317  
160mm crs  
169mm o/a  
30mm pj



▣ Exclusively available in Polished Chrome with Black Leather

Tuscan

8326  
160mm crs  
187mm o/a  
30mm pj



▣VP, UB  
▣AB, NB, OR, PB, PC, RB, SB



8326-OR



6756-BI

Cabinet Handles

Knobs

6061  
Cone Knob  
22mm Ø  
21mm pj



6149  
Lip Pull  
52mm  
18mm pj



Finishes: ▣BN ▣PC

6062  
Cone Knob  
28mm Ø  
26mm pj



Finishes: ▣BN ▣PC

6088  
25mm Ø  
31mm pj



▣SA ▣PC



6737-VP

6737  
33mm Ø  
25mm pj



▣AB (Pic), BLK, VP

Solid Brass Knobs

Button Style

6200 25mm, 19mm pj



6201 30mm, 23mm pj



6202 38mm, 27mm pj



Finishes: ▣AB, BN, PB, SC, UB  
▣NB, OR, PC, RB, SB

Mushroom Style



Diam Ø	Code	Finishes	Code	Finish	Code	Finish
25mm	6203	<span style="color: red;">▣</span> BN, PB, UB <span style="color: red;">▣</span> AB, NB, OR, PC, RB, SB	6209	<span style="color: red;">▣</span> SC	6212	<span style="color: red;">▣</span> CP
30mm	6204	<span style="color: red;">▣</span> BN, PB, UB <span style="color: red;">▣</span> AB, NB, OR, PC, RB, SB	6210	<span style="color: red;">▣</span> SC	6213	<span style="color: red;">▣</span> CP
38mm	6205	<span style="color: red;">▣</span> BN, PB, UB <span style="color: red;">▣</span> AB, NB, OR, PC, RB, SB	6211	<span style="color: red;">▣</span> SC	6214	<span style="color: red;">▣</span> CP

Basketweave

6756  
200mm crs  
215mm o/a  
40mm pj



6755  
128mm crs  
142mm o/a  
40mm pj



6781  
90mm x 30mm



▣Burnished Iron (BI)

Cup Handles

5018  
86mm x 44mm  
20mm pj



▣BN, CP, PB, SC, UB  
▣AB, NB, OR, PC, RB, SB

6729  
Concealed fix  
80mm x 29mm  
27mm pj



▣AB, BLK, VP

Black Iron

Pull Handles

2006 100mm o/a, 20mm pj  
2048 130mm o/a, 30mm pj  
2007 175mm o/a, 28mm pj



5180 Ring Handle  
38mm Ø



5188 Ring Handle  
50mm x 40mm



Knobs

2037 25mm, 27mm pj  
2038 30mm, 30mm pj  
2039 38mm, 39mm pj  
2040 50mm, 45mm pj



▣BLK



6737-VP



# Black Iron

## Black Iron > Door Furniture

See Page 92 for Care and Maintenance

### Knob Sets

2028 Oval Knob Set  
60mm Ø Rose



2011 Knob Set  
45mm Ø Knob  
62mm Ø Rose



### Push Plate

2024 Push Plate  
300mm x 65mm



### Pull Handle

2025 Pull Handle  
(Single)  
265mm o/a



### Lever Sets

2012 Standard Keyhole  
2013 Blank Plate  
2013 E48 Euro Keyhole (Pic)  
198mm x 54mm Plate



2015 Lever Set  
90mm x 53mm Plate



2014 Standard Keyhole (Pic)  
2030 Blank Plate  
2030 E48 Euro Keyhole  
158mm x 54mm Plate



2033 Lever Set  
118mm x 53mm Plate



2031 Standard Keyhole (Pic)  
2032 Blank Plate  
2032 E48 Euro Keyhole  
156mm x 53mm Plate



Finish: ▀BLK

The Windsor range of Black Iron products are cast from a quality malleable iron to form functional hardware in traditional styles

## Black Iron > Door & Window Accessories

See Page 92 for Care and Maintenance

### Hooks

2004 Cabin Hook  
100mm



2005 Cabin Hook  
150mm



### Bolts

2008 Straight Bolt, 118mm x 45mm



2009 Necked Bolt, 118mm x 40mm



2043 Straight Bolt, 200mm x 56mm



2044 Necked Bolt, 200mm x 60mm



### Escutcheons

2021 Escutcheon



2022 Escutcheon



2034 Euro Escutcheon  
37mm x 57mm



### Handles

2041 Trunk Handle  
105mm x 75mm



5188 Ring Handle  
50mm x 40mm



5180 Ring Handle  
38mm Ø



### Window Accessories

2018 Curly Window Stay  
285mm



2019 Curly Casement Fastener

### Knocker

2010 Knocker



### Hook

2017 Hat and Coat Hook



Finish: ▀BLK

### Knobs

2037 25mm



2038 30mm



2039 38mm



2040 50mm



### Pull Handles

2006 100mm o/a  
2048 130mm o/a  
2007 175mm o/a



▀ 2032 P-BLK / 8055-BLK / 1110-BLK

# Door Closers

## Door Closers > Light to Medium Duty

> Can be used in temperatures of -15°C to +40°C

303 2-4 strength, adjustable power by position



303-3-1 shown

303-7-1	Hold Open Pull Side Screw Arm inc. Cover	SC PC
303-7-0	Hold Open Pull Side Screw Arm exc. Cover	SC
303-3-1	Flat Bar Arm inc. Cover	BN, SC PC
303-3-0	Flat Bar Arm exc. Cover	SC

**Adjustable Closing Speed**

**Adjustable Latch Speed**

**Max Door Weight 60kg**

**Max Door Width 930mm**

**Opening Angle 180°**

**Power Size EN2-4**

**Universal Application**

324 2-4 strength, adjustable power by spring



324-3-2 shown

324-7-2	Hold Open Pull Side Screw Arm inc. Cover	SC PC
324-7-0	Hold Open Pull Side Screw Arm exc. Cover	SC
324-3-2	Flat Bar Arm inc. Cover	BN, SC PC
324-3-0	Flat Bar Arm exc. Cover	SC

**Adjustable Closing Speed**

**Adjustable Latch Speed**

**Max Door Weight 80kg**

**Max Door Width 1100mm**

**Opening Angle 180°**

**Power Size EN2-4**

**Back Check**

**Universal Application**

**Fire Rated**  
*Refer fire door manufacturer for approval*

## Door Closers > Heavy Duty

> Can be used in temperatures of -15°C to +40°C

525 2-5 strength, adjustable power by spring



525-3-3 shown

525-2-3	Screw Arm inc. Cover	SC PC
525-2-0	Screw Arm exc. Cover	SC
525-8-3	Hold Open Pull Side Screw Arm inc. Cover	SC PC
525-8-0	Hold Open Pull Side Screw Arm exc. Cover	SC
525-9-3	Hold Open Push Side Screw Arm inc. Cover	SC PC
525-9-0	Hold Open Push Side Screw Arm exc. Cover	SC
525-3-3	Flat Bar Arm inc. Cover	BN, SC PC
525-3-0	Flat Bar Arm exc. Cover	SC
525-5-3	Slide Arm inc. Cover	BN, SC PC
525-5-0	Slide Arm exc. Cover	SC
525-6-3	Hold Open Slide Arm inc. Cover	BN, SC PC
525-6-0	Hold Open Slide Arm exc. Cover	SC

**Adjustable Closing Speed**

**Adjustable Latch Speed**

**Max Door Weight 110kg**

**Power Size EN2-5**

**Opening Angle 180°**

**Adjustable Back Check**

**Universal Application**

**Max Door Width 1250mm**

**Adjustable Delayed Action**

**Fire Rated**  
*Refer fire door manufacturer for approval*

526 2-6 strength, adjustable power by spring



526-4-4 shown

526-2-4	Screw Arm inc. Cover	SC PC
526-2-0	Screw Arm exc. Cover	SC
526-8-4	Hold Open Pull Side Screw Arm inc. Cover	SC PC
526-8-0	Hold Open Pull Side Screw Arm exc. Cover	SC
526-9-4	Hold Open Push Side Screw Arm inc. Cover	SC PC
526-9-0	Hold Open Push Side Screw Arm exc. Cover	SC
526-4-4	Flat Bar Arm inc. Cover	BN, SC PC
526-4-0	Flat Bar Arm exc. Cover	SC
526-5-4	Slide Arm inc. Cover	BN, SC PC
526-5-0	Slide Arm exc. Cover	SC
526-6-4	Hold Open Slide Arm inc. Cover	BN, SC PC
526-6-0	Hold Open Slide Arm exc. Cover	SC

**Adjustable Closing Speed**

**Adjustable Latch Speed**

**Max Door Weight 120kg**

**Power Size EN2-6**

**Opening Angle 180°**

**Adjustable Back Check**

**Universal Application**

**Max Door Width 1400mm**

**Adjustable Delayed Action**

**Fire Rated**  
*Refer fire door manufacturer for approval*



Door Closers > Cam Action & Drop Plates

> Cam action closer for ease of opening

724 2-4 strength, adjustable power by spring



724-10-5 shown

724-10-5	Slide Arm inc. Cover & Cushion Stop	▣BN, SC ▣PC
724-10-0	Slide Arm exc. Cover & Cushion Stop	▣SC
724-11-5	Hold Open Slide Arm inc. Cover	▣BN, SC ▣PC
724-11-0	Hold Open Slide Arm exc. Cover	▣SC

- Adjustable Closing Speed
- Adjustable Latch Speed
- Max Door Weight 60kg
- Max Door Width 950mm
- Opening Angle 120°
- Power Size EN2-4
- Universal Application
- Fire Rated  
*Refer fire door manufacturer for approval*

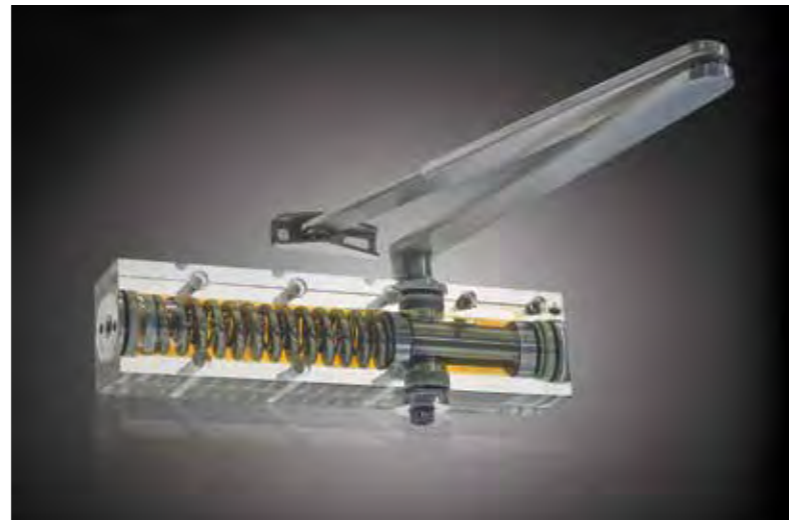

Drop Plates

901 To suit 525 Closer  
902 To suit 526 Closer (Pic)



Finishes: ▣SC ▣PC



> 526-9-0-SC Closer / Includes parallel Arm Bracket and Hold Open + 902 Drop Plate

Locks, Latches & Cylinders

Locks, Latches, Cylinders > Latches & Safety Latches

Refer to Page 93 for Rebate Kits, Extended Strike Plates and Strike Packers

Latches

Tubular Latch

1131 60mm b/s, 25mm Ø, 84mm c/s



- > 45° Short Action
- > Plastic recess shield included for tidy installation of strike

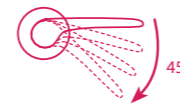

Finishes: ▣AB, BLK, BN, SC, TG  
▣PC

NEW Heavy Duty Tubular Latch

1360 60mm b/s, 25mm Ø, 80mm c/s

- > Dual springing system for extra soft closing action - saves having to slam the door
- > Short 45° lever action makes opening your door easy
- > Standard 25mm crop-out

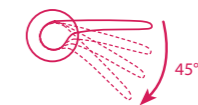

Finishes: ▣BLK, SS ▣PC



1151  
Strike & Recess Box



▣BN, SC, TG  
▣PC

Heavy Duty Tubular Latch

1213 45mm b/s, 67mm c/s  
1172 57mm b/s, 77mm c/s  
1242 83mm b/s, 102mm c/s

- > Double sprung, soft close
- > 25mm Ø Mortice
- > Thru-fix on 1172 & 1242

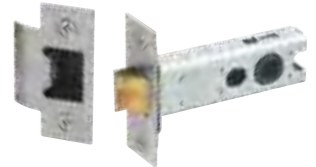

Finishes:  
▣AB, PVD, SS  
▣NB, OR, PC, RB, SB, UB

1101 70mm b/s  
25mm Ø, 92mm c/s



- > 45° short action

▣AB, BLK, BN, PB, SC  
▣PC

1106 45mm b/s  
25mm Ø, 65mm c/s



▣AB, BLK, CP, PB  
▣PC

1100 57mm b/s  
25mm Ø, 76mm c/s



Mortice Latch

1112 57mm b/s, 77mm x 39mm c/s



▣PB, SS, UB  
▣AB, NB, OR, PC, RB, SB

Safety Latches

Ideal for swimming pool situations, where council regulations require a self latching gate or door. Normally used with a door closer (see page 81-83).

Slimline Safety Latch

47mm c/s  
60mm x 30mm Plates

1267 Slimline Safety Latch  
1268 Slimline Safety Latch-lockable (Pic)



Finishes: ▣BN, SC ▣PC

NEW Safety Latch Round

9095 60mm b/s



- > Heavy Duty Latch
- > 60mm Backset
- > 54mm Ø Roses

- > Thru-fixing
- > Ideal for use on entry doors with electronic or standard Deadbolts & Pull Handles

Finishes: ▣BLK, BN, GN, SC ▣PC

NEW Safety Latch Square

9096 60mm b/s



- > Heavy duty latch
- > 60mm Backset
- > 54mm Square Roses

▣BLK, BN, SC ▣PC

NEW Matt Black available ex stock

54mm Ø Roses  
8mm Spindle  
8120 45mm b/s  
8121 57mm b/s  
8122 70mm b/s



54mm Square Roses  
8mm Spindle  
8123 45mm b/s  
8124 57mm b/s  
8125 70mm b/s



▣BLK, BN, SC ▣PC

26.5mm Ø Roses  
5200 45mm b/s  
5201 57mm b/s  
5202 70mm b/s

- > Stepped Spindle



▣PB, SC, UB  
▣AB, PC

**Locks, Latches, Cylinders > 3 & 5 Lever Locks, Privacy Bolts, Catches, Magnets**

Refer to Page 93 for Rebate Kits, Extended Strike Plates and Strike Packers

**Three Lever Locks**

- > Economy with medium security
- > 100 key differs
- > Includes two keys

1107 45mm b/s, 65mm c/s  
1108 57mm b/s, 78mm c/s



**Three Lever Key Blank**

1117 L 1-50  
1117 R 51-99

NEW 1117E L  
1117E R

- > Key blanks for added convenience of extra keys
- > If key has a stamped "E" use new series keys

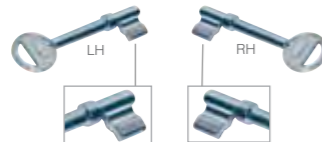

Finishes: ▣AB, BLK, CP, PB ▣PC

**Five Lever Locks**

- > Rugged construction
- > Anti-saw rollers for high security
- > Includes two keys

1103 45mm b/s, 66mm c/s  
1104 57mm b/s, 78mm c/s



**Five Lever Key Blank**

1118



- > Available keyed alike

▣AB, BLK, PVD, SS  
▣NB, OR, PC

**Roller Catches**

1119  
"T" Striker  
Included



▣AB, CP, PB

**Heavy Duty Mortice Roller Catch**

1195 67mm x 62mm c/s

- > Adjustable roller

▣SS ▣PC



**Door Magnets**

1180 25mm x 7mm (Pic)  
1180-5 25mm x 7mm, 5pk

1262 22mm x 8mm (Pic)  
1262-5 22mm x 8mm, 5pk

1265 25mm x 10mm



- > Bumpstop and screws supplied
- > Includes rubber buffers for a soft close
- > Made from N42 grade raw material for superior magnet strength

**Privacy Bolts**

**Tubular**

1120 Tubular 60mm b/s

- > 6mm Drive

Finishes:  
▣AB, BLK, BN, PB  
▣PC



**Tubular**

1203 Tubular 70mm b/s

- > 6mm Drive

▣PB, SS, UB  
▣AB, NB, OR, PB, PC



**Heavy Duty Tubular**

1173 Tubular 57mm b/s  
1243 Tubular 83mm b/s

- > Thru-fix
- > 25mm Ø Mortice
- > 5mm Drive

▣AB, PVD, SS  
▣NB, OR, PC, RB, SB, UB



**Mortice Bolt**

1111 Mortice Bolt  
57mm b/s

- > 5mm Drive

▣PB, SS, UB  
▣AB, NB, OR,  
PC, RB, SB



**Bathroom Lock / Latch**

1110 57mm b/s  
78mm c/s

- > Dust box available on request
- > 5mm Drive

▣AB, BLK, CP, PB  
▣PC

1136 45mm b/s  
65mm c/s

▣CP, PB  
▣PC



**Locks, Latches, Cylinders > Euro Profile Locks, Night Latches & Roller**

Refer to Page 93 for Rebate Kits, Extended Strike Plates and Strike Packers

**Euro Profile Locks**

**Euro 48**

1114 45mm b/s, 66mm c/s  
1115 57mm b/s, 78mm c/s  
1169 Lock Kit (Rebated)  
1114 + 1105 + 1148  
1170 Lock Kit  
1115 + 1148

- > Suitable for thru-fixing
- > High Security Lock
- > Easi-T quick reversal system for Latch

▣AB, PVD, SS, UB  
▣NB, OR, PC, RB, SB



1350 45mm b/s, 66mm c/s

1352 57mm b/s, 78mm c/s

1351 Rebate lock combo 45mm b/s



▣PVD, SS  
▣AB, PC

**Night Latch**

**Heavy Duty with Anti-thrust**

1215 (-SS only)

57mm b/s, 78mm c/s

1216 Round Lock Kit with key / turn & escape

1217 Square Lock Kit with key / turn & escape

- > Use with Windsor Pull Handles or as a combination with Lever & Escutcheon

▣BN, SC ▣PC



**Euro 85**

1226  
30mm b/s  
47mm c/s

▣SS  
▣AB, PC

1227  
35mm b/s  
52mm c/s

▣PVD, SS  
▣AB, PC

- > Latch retracts with cylinder



**Euro 85**

NEW Graphite Nickel available ex stock (1143 and 1143 ST only)

1142 45mm b/s, 71mm c/s  
20mm throw

1143 60mm b/s, 86mm c/s  
20mm throw

1143 ST  
10mm short throw

- > Suitable for thru-fixing
- > Features 2 stage bolt throw
- > Latch retracts with cylinder

▣AB, BLK, PB, SS, UB  
▣NB, OR, PC, RB, SB



**Deadbolt**

1130 45mm b/s, 66mm c/s  
1135 57mm b/s, 78mm c/s



- > Use with Euro profile cylinder and escutcheons

▣PVD, SS  
▣PC

**Roller Locks**

**Heavy Duty**

1139  
45mm b/s, 65mm c/s

1140  
57mm b/s, 76mm c/s

▣PB, SS, UB  
▣AB, NB, OR, PC, RB, SB



1156 (-SS only) 57mm b/s, 78mm c/s

1149 Lock Kit Round Key/Key

1150 Lock Kit Round Key/Turn

1157 Lock Kit Square Key/Turn

- > Features forend roller adjustment

1150 Lock Kit shown with 7025 Pull Handle sold separately

▣BN, SC ▣PC



**Sliding Door Locks**

**Heavy Duty Euro Lock**

1279  
57mm b/s, 78mm c/s

Finishes:  
▣PB, SS, UB  
▣AB, NB, OR, PC, RB, SB



**Euro Lockcase**

1179 50mm b/s

▣SS ▣PC





# Pull Handle Entrance Lock Kits

## Pull Handle Entrance Lock Kits > Mini Lever & Double Turn

Refer to Page 93 for Rebate Kits, Extended Strike Plates and Strike Packers

### NEW Mini Lever Lock Kits

1364 Mini Lever Lock Kit Round  
60mm Backset Lockset

1365 Mini Lever Lock Kit Square  
60mm Backset Lockset



Designed with large flat surface area on side of turn making it simpler and easier to use  
Thru-fixing for easy alignment on the door, preventing binding

Finishes: ▶BLK, BN, GN, SC  
▶PC

### Pull Handle Lock Kit

#### Rollerbolt Alternative

Are you looking for a lock that:

- > Won't blow open in the wind
- > Doesn't need to be slammed closed

Then look no further than the latest kits from Windsor

- > With a neat compact thumb turn action that retracts a positive latch
- > Specifically designed for New Zealand conditions
- > All kits include Eurolock, Cylinder and Turn, Double Turn Set and Escutcheons
- > Retract Latch and Deadbolt off key turn from inside (longcase only)

### Double Turn Lock Kits

1182 Round (Pic)  
46mm Ø Roses  
57mm Backset Lock  
(PB, UB, AB, NB, OR, RB, SB -  
50mm Ø Roses)

NEW Graphite Nickel available ex stock

1183  
54mm Ø Roses  
60mm Backset Lock  
(PB, UB, AB, NB, OR, RB, SB -  
50mm Ø Roses)

NEW Graphite Nickel available ex stock

1184  
54mm Square Roses  
60mm Backset Lock

1258 (Pic)  
60mm x 30mm Roses  
60mm Backset Lock

1259  
60mm x 30mm Roses  
35mm Backset Lock



Shortcase  
(Outside pictured)  
Finishes:  
▶BLK, BN, PB, SC, UB  
▶AB, NB, OR, PC, RB, SB

1241 Square  
51mm Square Roses  
57mm Backset Lock

Finishes: ▶BN, SC  
▶PC



Longcase  
(Inside pictured)

▶BLK, BN, GN, PB, SC, UB  
▶AB, NB, OR, PC, RB, SB



Longcase  
(Outside pictured)

▶BLK, BN, GN, SC  
▶PC



Longcase  
(Inside pictured)

▶BN, SC  
▶PC

## Locks, Latches, Cylinders > Euro Profile Cylinders

Cylinders can be supplied keyed alike

### 5 pin Euro Profile Cylinders

#### Double Cylinder

1121 5 pin, 60mm  
1147 5 pin, 70mm



▶AB, BLK, BN, PB, SC, UB  
▶NB, OR, PC, RB, SB

#### Cylinder Turn

1122 5 pin, 60mm  
1148 5 pin, 70mm



NEW Graphite Nickel available ex stock (1148 only)  
Shown in GN  
▶AB, BLK, BN, GN, PB, SC, UB  
▶NB, OR, PC, RB, SB

#### Single Cylinder Key

1133 5 pin, 30mm  
1199 5 pin, 35mm



### 3 pin Euro Cylinder

#### Double Cylinder

1178 3 pin, 38mm



▶BN ▶PC

#### Single Cylinder Turn

1134 30mm  
1200 35mm

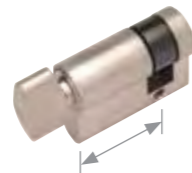

(Measurement to cam/screw centre)

▶AB, BLK, BN, PB, SC, UB  
▶NB, OR, PC, RB, SB



^ 3008 E48-OR / 1147-OR

### 6 pin Euro Profile Cylinders

#### Double Cylinder

1246 6 pin, 70mm



▶SC ▶PC

#### Cylinder Turn

1247 6 pin, 70mm



- > 6 pin C4 key profile, suits security plugs
- > Quality stainless steel grub screws for quick easy re-keying
- > Constructed from high quality extruded brass

# Keyless Entry

## Pull Handle Entrance Lock Kits > Uni-Turn

Refer to Page 93 for Rebate Kits, Extended Strike Plates and Strike Packers

### Uni-Turn Lock Kits

**NEW** Graphite Nickel available ex stock

**1248**  
54mm Ø Roses  
60mm Backset Lock  
(PB, UB, NB, OR, RB, SB - 50mm Ø Roses)



Outside Inside

**NEW** Graphite Nickel available ex stock

**1249**  
54mm Square Roses  
60mm Backset Lock



Outside Inside

**1250 (Pic)**  
60mm x 30mm Roses  
60mm Backset Lock  
**1251**  
60mm x 30mm Roses  
35mm Backset Lock



Inside Outside

Finishes: **BLK, BN, GN, PB, SC, UB**  
**AB, NB, OR, PC, RB, SB**

**BLK, BN, GN, SC**  
**PC**

**BN, SC**  
**PC**

- > New single turn design guaranteed to eliminate binding
- > Brushed Nickel and Satin Chrome finishes with greater corrosion resistance
- > Save time on installation, with square drive fixing screws suited to aluminium joinery industry
- > Available to order in a range of special finishes



1369-BN ML Combo - Ref. page 9



1249-BN



7026-SS / 1331-BN

Give your home or office a touch of effortless style



9047-BN / 1331-BKN



7183-SS / 1317-BN

Ordering Leadtimes: **1-2 Days** **14 Days**

Refer Inside Front Cover for further details on ordering leadtimes





Combining the best in technology and design, we have developed our most popular Astron lever styles into convenient electronic mortice locks

Keyless Entry > Electronic Levers & Double Turn Lock

Qube

1342R Electronic Lockset - Includes 2 remotes  
1342 Electronic Lockset - Without remotes

- > Touch to activate, touch to lock
- > Replaces your existing mortice lock
- > Minimal tools required for installation
- > Uses RF technology for minimal interference
- > Powered by AA batteries - no hard-wiring required
- > Includes timed auto-lock functionality



Outside

Inside

Keyless Entry > Electronic Levers & Double Turn Lock

Daily Convenience

- > Back-up mechanical keyway
- > Tactile activation and locking
- > Large buttons and illuminated keypad for ease of use in low light areas or at night
- > Up to 10 personalised user codes can be programmed
- > Low battery indicator light warns you when new batteries are required

Uncompromised Security

- > Keypad is temporarily disabled after 4 consecutive incorrect entries
- > Optional auto-lock timer with 10 second delay
- > Temporary codes can be programmed - ideal for tradesmen

Easy Installation

- > Replace your existing Euro 85 mortice lock
- > Minimal tools required for installation
- > Suits standard door thicknesses from 38mm-55mm
- > Graphic step-by-step installation instruction & door cropping template supplied

Product Specifications

**User Codes:** 10 sets (2 to 8 digits each)  
**Programming Code:** 1 set (2 to 8 digits)  
**Keys Included:** 3  
**Size (HxWxD):** Exterior lock body: 255mm x 69mm x 14mm  
 Interior lock body: 243mm x 71mm x 30mm  
**Finish:** Brushed Nickel or custom Powdercoat  
**Door Bore Hole:** 25mm (spindle) & 38mm (deadbolt)  
**Door Thickness:** 38mm to 55mm  
**Backset:** 60mm  
**Power:** DC 6V (four AA 1.5V alkaline batteries)  
**Base Material:** Solid Brass  
**Touch Screen Back-light Colour:** Green  
**Operating Frequency:** 433.92 MHz ± 150KHz

Additional Info

- > 5 pin C4 profile Keyway – Common C4 keying allows you to easily rekey this lock to match the other doors in your house
  - > Optional rubber housing provided for weather protection
- With remote option only:**
- > 2 radio frequency remotes (433MHz) with a range of 15-20m included
  - > Up to 10 remotes can be programmed for the same lock

Double Turn

1340R Electronic Lockset - Includes 2 remotes  
1340 Electronic Lockset - Without remotes



Luna

1341R Electronic Lockset - Includes 2 remotes  
1341 Electronic Lockset - Without remotes



Vector

1343R Electronic Lockset - Includes 2 remotes  
1343 Electronic Lockset - Without remotes



Vulcan

1344R Electronic Lockset - Includes 2 remotes  
1344 Electronic Lockset - Without remotes



Finishes: ▀BN ▀PC

Rebate Kit

- 1356 Rebate Kit
- > LH or RH available
  - > To suit 1340, 1341, 1342, 1343 & 1344

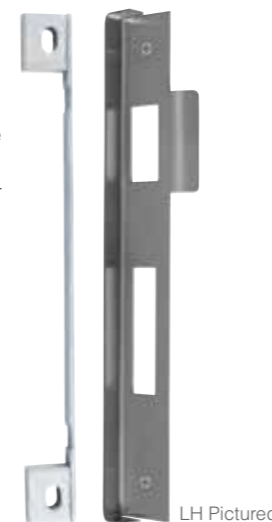

Finishes: ▀SS ▀PC

LH Pictured

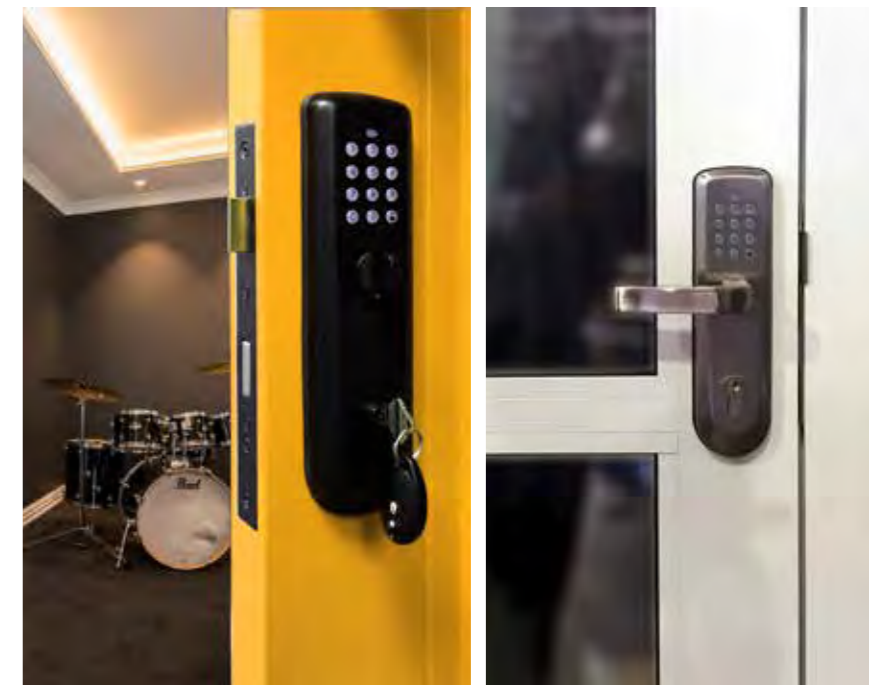

1340R-PC (Matt Black)

1342-BN

Entrance security locks with electronic convenience from Windsor

## Keyless Entry > Card Entry Lever & Deadbolt Lockset

Refer to Page 98 for Rebate Kits

### NEW Card Entry Lever Lockset

1335S Touchscreen Lever Entrance Set



Inside

Outside

Finish: ▀BN, BKN

- > Unlocks with supplied cards, pincodes or keys supplied
- > 2 cards, 2 keys and 4 batteries included
- > Replacement cards available - please enquire
- > 1335S unlocks with your own valid RFID card, can be programmed with a range of user cards - see [www.windsorbrass.co.nz](http://www.windsorbrass.co.nz) for more details

### NEW Card Entry Deadbolt Lock

1331S Touchscreen Deadbolt Set



Inside

Outside

## Daily Convenience

- > Back-up mechanical keyway
- > Sensitive touchscreen for ease of use
- > Single-entry user codes available
- > Volume control (gradational options and mute mode)
- > Anti-tamper mode (deactivates all user codes temporarily)
- > Entrance set or deadbolt options available, both the same programming

## Easy Installation

- > Retro fit over your existing deadbolt holes
- > Minimal tools required for installation
- > Suits standard door thicknesses from 35mm-51mm
- > Graphic step-by-step installation instructions supplied

## Keyless Entry > Electronic Keypad Deadbolts

Refer to Page 98 for Rebate Kits

### Electronic Deadbolt Locks

- 1317 Keypad Lock + Remote
- 1320 9046 Gripset + 1317 Keypad Lock
- 1321 9047 Gripset + 1317 Keypad Lock
- 1322 1195 Roller Catch + 1317 Keypad Lock
- 1318 Additional remote only



Inside

Outside

- > 3 ways to open – pin code, remote or key
- > 2 remotes and 2 keys included
- > 4 batteries included

Finishes: ▀BLK, BN ▀PC (Keypad side only)

> Matt Black available ex stock



## Uncompromised Security

- > ANSI Grade 2 certified - tested to over 150,000 times
- > ANSI A156.25 compliant - resistant to dust, rain and corrosion under variable temperatures
- > Four-digit guiding code (prevents code-probing by increasing fingerprints on the touch screen)
- > Touch screen is temporarily disabled after 4 consecutive incorrect entries
- > Auto-lock timer with adjustable delay (programmable from 10-99 seconds)

## Product Specifications

**User Codes:** Up to 25 sets (4 to 8 digits each)

**Programming Code:** 1 set (4 to 8 digits)

**Keys Included:** 2

**Entrance Set Size (HxWxD):**

*Exterior lock body:* 156mm x 76mm x 32mm

*Interior lock body:* 156mm x 75mm x 34mm

**Deadbolt Size (HxWxD):**

*Exterior lock body:* 138mm x 65mm x 26mm

*Interior lock body:* 174mm x 70mm x 38mm

**Finishes:** Brushed Nickel or Black Nickel

**Door Bore Hole:** 54mm or 38mm

**Door Thickness:** 35mm to 51mm

**Adjustable Backset:** 60mm to 70mm

**Touch Screen Back-light Colour:** Blue

**Power:** DC 6V (four AA 1.5V alkaline batteries)

**Operation Temperature:** -35°C to +66°C

- > Radio frequency remotes for longer range
- > Never before has electronic convenience of this quality been available at such great value
- > Easy DIY installation, retrofits over standard deadbolt holes
- > High security deadbolt with anti-saw protection
- > Can be used in conjunction with Lever Handles, Pull Handles or Gripsets
- > 10 user codes can be programmed
- > Temporary contractor codes can be programmed
- > C4 profile for easy rekeying to the rest of your house
- > Long-life battery power, no wiring required
- > 110mm minimum stile width recommended
- > Suit 38mm-50mm door thicknesses
- > Adjustable 60mm or 70mm Backset



3 ways to unlock



Card



Code



Key

1331S-BN





7024-PB



7096-SS



8309L-ATL



5184-NB



2032-BLK



8169 E48-OR

## Gloss Lacquered Finishes

The high polish of Windsor Brass products is treated with a clear protective coating to provide durability. Brass, like sterling silver, will gradually tarnish and take on an antique appearance. Atmospheric conditions, caustic agents such as paints, or scratches from sharp objects may cause the protective coating to crack or peel causing spotting and discolourations. However, the beauty of the metal can be maintained by taking a few simple steps.

Initial care for lacquered brass requires only a quick rub with Windsor Wax Polish and light buffing with a soft cloth. You may prefer to do this weekly, especially in exterior, often used or damp environments.

"Blue Magic" Metal Polish is a quick, effective way of restoring mildly tarnished brassware. If heavy discolouration occurs the finish can be restored by stripping the remaining lacquer and polishing regularly with "Blue Magic". Alternatively let it age naturally to an antique finish. The beauty of solid brass is that it can always be restored to its original lustre.

## Stainless Steel

To aid the longevity and appearance of quality Windsor stainless steel products, we recommend that it is kept clean and a metal polish such as "Blue Magic" be applied periodically. Atmospheric conditions, salt deposits, acids, caustic agents, cement or dust on construction sites all have the potential to cause discolouration to the surface.

If this occurs do not be concerned as usually this is not the stainless steel itself but particles clinging to its surface. The product can be revived by following the above maintenance procedure and repeating regularly. This small amount of routine care can only preserve the elegance of your Windsor stainless steel hardware.

## Leather

Windsor's range of fine Italian leather products are protected by a urethane covering. Even so, they will need gentle care and maintenance to keep them in top condition. Clean leather products regularly with a soft, damp cloth as dirt and grime can act as abrasives on leather. Use an appropriate leather furniture conditioner periodically as required. This will depend on frequency of use of the hardware and proximity to sunlight. Wipe off food and body oils as soon as possible as they will oxidise and change the colour of the leather. Don't use water, cleaning solvents, soaps or ammonia based products to clean the leather; Water based stains will leave a permanent mark. This small amount of routine care can only preserve the elegance of your Windsor leather hardware.

## Living Finishes

The finish on Windsor's architectural brass products is an oxidation treatment which continues to age when it comes in contact with the atmosphere. Over time, the natural patina of the bronze finish will give way to an aged brass finish in heavy use areas. For care and maintenance, a gentle wipe with a damp cloth should keep your architectural brass hardware in top condition.

## Black Iron

Windsor's Black Iron range has a powdercoated finish. Iron naturally oxidises, especially when exposed to the weather, and this can occur if the powdercoating is scratched or chipped. The iron itself will not deteriorate with oxidation, other than the discolouration of the surface, as the oxidation forms a skin on the surface unlike steel which continues to rust. Small chips can be touched up with a black wax crayon as the wax will provide weather protection. Larger areas can be restored with a black etch paint such as PA10.

5093  
Wax Polish  
50 gms



055  
Blue Magic  
Stainless Polish



1276  
Threadlock  
> Medium Strength  
> Suitable for approx.  
20 Grubscrews



# Technical

## Lock Accessories

### Rebate Kits

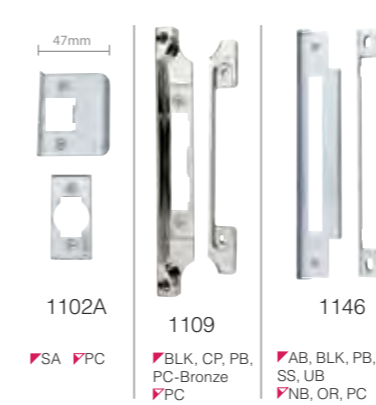

### Extended Strikes



### Strike Packers

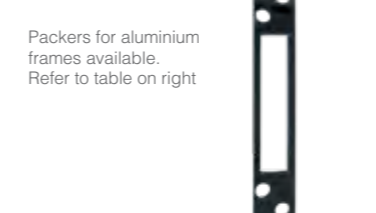

Lock / Latch	Rebate Kit	Extended Strike	Packer 8mm	Packer 10mm
1100	1102	1163	1210	1211
1101	1102A	1163		
1103/1104	1105	1164	1159	1155
1106	1102	1163	1210	1211
1107/1108	1109	1165		
1110	1109	1165		
1111	1113			
1112	1113	1163		
1114/1115	1105	1164	1159	1155
1120	1240			
1130	1132			
1131	1102A	1163		
1135	1132			
1136	1109	1165		
1139/1140	1144	1162	1158	1154
1142	1146	1187 LH or RH	1186	1185
1143	1146	1187 LH or RH	1186	1185
		1234 LH or RH		
1145	1102A	1163		
1156	1181 LH or RH	1162	1161	1160
1168	1109			
1172	1174	1163	1210	1211
1173	1174			
1182	1105	1164	1159	1155
1183/1184	1146	1187 LH or RH	1186	1185
		1234 LH or RH		
1195	1196	1209	1210	1211
1213	1174	1163	1210	1211
1215	1218 LH or RH	1230	1228	1229
1226/1227	1146	1187 LH or RH	1186	1185
		1234 LH or RH		
1241	1105	1164	1159	1155
1241	1105	1164	1159	1155
1242	1174	1163	1210	1211
1242	1174	1163	1210	1211
1243	1174			
1248/1249	1146	1187 LH or RH	1186	1185
		1234 LH or RH		
1250/1251	1146	1187 LH or RH	1186	1185
		1234 LH or RH		
1258/1259	1146	1187 LH or RH	1186	1185
		1234 LH or RH		
1267/1268	1146	1187 LH or RH	1186	1185
		1234 LH or RH		
1279	1280			
1317	1240			
1319	1240			
1350	1354	1164		
1352	1354	1164		
9011/9012	1240			
9046	1240/1102A			
9047	1240/1102A			
1331/1331S	1240			
1335/1335S	1102A			
1203	1240			
9046	1240/1102A			

### Rebate Kit

1105  
To suit:  
1103  
1104  
1114  
1115  
1182  
1241

- > Full wrap around style for improved aesthetics
- > Less vertical clearance between Faceplate and Striker for a tighter seal
- > Available to suit both Euro and 5 Lever Mortice Locks
- > To suit standard width door

Finishes: ▽AB, BLK, PVD, SS  
▽NB, OR, PC

### Extended Tongue Rebate Kit

1277

- > Suitable for rebated doors 44mm-56mm in thickness
- > Especially suited for use with double glazed doors, where standard 1105 is not wide enough

▽SS  
▽AB, PC

### Roller Lock Rebate Kit

1181  
To suit: 1156, 1149, 1150, 1157

- > Left or Right Handed available
- > Full wrap around style
- > Suits doors 40mm to 50mm thick
- > Stainless steel construction

▽SS ▽PC

### Extended Tongue Rebate Kit

1316

- > Left or Right Handed available
- > Suits doors 45mm-55mm thick
- > Especially suited for use with double glazed doors, where the standard 1146 rebate kit is not wide enough
- > To be used with 85mm centres Euro Locks

▽SS  
▽AB, PC

# Product Code Index

Code	Page	Code	Page	Code	Page	Code	Page	Code	Page	Code	Page	Code	Page	Code	Page	Code	Page
055	92	1195	82	1371	14	5053	65	5256	52	6068	72	7012	31	7128	9	7334	44
303	78	1196	93	1373	7	5056	63	5257	61	6069	72	7013	31	7129	9	7335	44
324	78	1199	84	1374	7	5057	56	5258	53	6071	70	7015	42	7130	9	7336	44
525	79	1200	84	2004	77	5059	56	5259	61	6072	70	7019	41	7131	9	7337	44
526	79	1203	82	2005	77	5060	65	5260	62	6073	70	7020	56	7134	5	7338	44
724	80	1209	93	2006	75	5062	52	5261	62	6074	70	7024	8	7142	10	7339	44
901	80	1210	93	2007	75	5063	53	5262	52	6075	70	7025	13	7143	10	7341	44
902	80	1211	93	2008	77	5069	30	5263	53	6076	70	7026	13	7144	10	7342	44
1100	81	1213	81	2009	77	5070	30	5264	52	6077	73	7027	10	7145	10	7343	44
1101	81	1215	83	2010	77	5071	29	5265	52	6088	75	7028	10	7146	10	7344	44
1102	93	1216	83	2011	76	5072	29	5267	61	6106	73	7030	42	7147	10	7345	44
1102A	93	1217	83	2012	76	5086	63	5268	63	6107	73	7032	57	7148	40	7346	44
1103	82	1218	93	2013	76	5090	52	5269	65	6108	73	7033	42	7149	40	7347	44
1104	82	1221	6	2014	76	5092	65	5270	54	6149	75	7034	42	7150	40	7348	44
1105	93	1222	84	2015	76	5093	92	5271	54	6200	75	7035	42	7151	40	7349	44
1106	82	1223	84	2017	77	5127	29	5272	54	6201	75	7036	41	7152	40	7350	44
1107	82	1224	84	2018	77	5128	29	5273	54	6202	75	7037	41	7153	40	8003	56
1108	82	1225	84	2019	77	5129	29	5274	52	6203	75	7038	41	7154	7	8017	24
1109	93	1226	83	2021	77	5130	29	5275	56	6204	75	7042	42	7159	12	8027	24
1110	82	1227	83	2022	77	5131	30	5276	56	6205	75	7043	42	7160	12	8028	24
1111	82	1228	93	2024	76	5132	30	5277	53	6209	75	7044	42	7161	12	8029	24
1112	81	1229	93	2025	76	5133	53	5278	52	6210	75	7045	42	7162	12	8033	24
1113	93	1230	93	2028	76	5135	56	5297	65	6211	75	7046	41	7163	12	8034	24
1114	83	1231	14	2030	76	5136	64	5298	52	6212	75	7048	42	7164	12	8035	24
1115	83	1232	13	2031	76	5137	29	5299	52	6213	75	7049	42	7165	15	8036	24
1117	82	1234	93	2032	76	5138	31	5304	62	6214	75	7050	42	7166	15	8037	24
1117E	82	1238	9	2033	76	5139	31	5305	62	6314	68	7051	42	7167	15	8038	24
1118	82	1239	5	2034	77	5140	66	5306	62	6315	68	7052	42	7168	15	8041	58
1119	82	1240	93	2035	80	5142	56	5307	52	6316	68	7053	42	7170	15	8042	58
1120	82	1241	88	2037	75	5143	56	5308	54	6333	72	7054	14	7171	15	8046	24
1121	84	1242	81	2038	75	5144	56	5309	61	6334	72	7055	14	7173	15	8047	24
1122	84	1243	82	2039	75	5148	29	5315	52	6335	72	7056	43	7174	15	8048	24
1130	83	1246	84	2040	75	5149	29	5316	53	6336	71	7057	41	7181	10	8049	24
1131	81	1247	84	2041	77	5153	66	5317	61	6337	71	7058	41	7182	9	8055	58
1132	93	1248	86	2043	77	5154	61	5318	61	6338	71	7059	41	7183	9	8067	53
1133	84	1249	86	2044	77	5155	61	5319	61	6339	71	7060	41	7184	15	8079	60
1134	84	1250	86	2048	75	5157	31	5320	62	6340	71	7061	41	7185	15	8088	60
1135	83	1251	86	3002	30	5158	31	5321	62	6341	72	7062	31	7187	8	8089	57
1136	82	1258	85	3003	30	5166	66	5322	62	6345	72	7063	11	7188	8	8090	34
1137	51	1259	85	3004	30	5167	66	5323	64	6357	73	7064	10	7189	8	8091	34
1139	83	1262	51	3006	30	5170	66	5324	64	6358	73	7065	10	7190	8	8099	34
1140	83	1265	51	3007	30	5171	66	5325	53	6382	73	7066	14	7191	42	8100	34
1141	51	1267	81	3008	30	5175	63	5326	59	6413	68	7067	58	7192	41	8101	57
1142	83	1268	81	3009	30	5177	61	5327	59	6414	68	7069	5	7193	42	8102	56
1143	83	1269	62	3010	30	5179	29	5328	59	6415	68	7070	5	7194	42	8103	34
1144	93	1270	62	3011	30	5180	75	5329	59	6426	71	7071	58	7195	41	8104	58
1145	93	1271	62	3013	30	5184	63	5330	59	6427	71	7072	57	7196	41	8105	60
1146	93	1273	5	3014	30	5185	63	5331	59	6428	71	7076	57	7197	40	8106	60
1147	84	1276	92	3015	30	5186	52	5332	59	6429	71	7080	42	7198	40	8107	60
1148	84	1277	93	3016	30	5187	64	5333	59	6430	71	7081	41	7201	36	8109	34
1149	83	1278	51	3017	30	5188	75	5335	59	6431	71	7083	42	7202	36	8110	34
1150	83	1279	92	3018	30	5190	65	5336	59	6434	70	7084	42	7203	36	8113	58
1151	81	1280	93	3019	30	5191	65	5339	59	6435	70	7085	41	7204	36	8114	34
1152	51	1287	7	3020	30	5192	58	5340	59	6436	70	7092	13	7205	36	8115	34
1154	93	1301	93	3024	65	5194	64	5341	52	6437	70	7093	13	7211	36	8118	57
1155	93	1314	51	3034	56	5195	64	5342	52	6438	70	7094	13	7212	36	8120	81
1156	83	1315	51	4001	29	5196	65	5343	64	6439	70	7095	14	7213	36	8121	81
1157	83	1316	93	4002	29	5197	65	5344	64	6484	69	7096	14	7214	36	8122	81
1158	93	1317	91	4003	29	5198	57	5346	54	6485	69	7097	14	7215	36	8123	81
1159	93	1318	91	4004	29	5199	57	5352	66	6487	69	7098	6	7221	36	8124	81
1160	93	1320	91	4005	29	5200	81	5353	66	6489	69	7099	6	7222	36	8125	81
1161	93	1321	91	4006	29	5201	81	5354	63	6490	69	7100	6	7223	36	8126	34
1162	93	1322	91	4007	29	5202	81	5355	63	6491	69	7101	6	7224	36	8128	33
1163	93	1326	8	4016	56	5205	63	5356	63	6492	70	7102	6	7225	36	8129	33
1164	93	1331S	90	4021	29	5207	55	5357	53	6493	70	7103	5	7231	36	8130	33
1165	93	1335S	90	4028	29	5208	55	5360	65	6494	70	7104	5	7232	36	8131	33
1167	51	1340	88	4029	29	5209	55	5361	64	6495	70	7105	41	7233	36	8132	33
1168	93	1341	88	4030	29	5210	55	5362	64	6496	70	7106	41	7234	36	8133	33
1169	83	1342	88	4031	29	5211	55	5363	61	6497	70	7107	41	7235	36	8134	33
1170	83	1343	88	4032	65	5212	55	5364	61	6498	70	7108	41	7238	7	8135	33
1171	51	1344	88	5002	29	5213	55	5378	54	6499	70	7109	41	7239	7	8136	34
1172	81	1350	83	5003	29	5214	55	5382	53	6500	70	7110	41	7240	7	8137	34
1173	82	1351	83	5004	29	5215	55	5900	51	6501	70	7112	40	7241	7	8138	34
1174	93	1352	83	5005	29	5224	55	5901	51	6729	75	7113	40	7313	44	8141	60
1178	84	1354	93	5006	29	5225	54	5902	51	6737	75	7114	40	7314	44	8142	33
1179	83	1356	89	5007	29	5226	54	5903	51	6749	72	7115	40	7315	44	8143	33
1180	51	1357	49	5015	51	5228	61	5904	51	6750	72	7116	40	7316	44	8144	33
1181	93	1358	49	5016	51	5229	52	6002	73	6751	72	7117	40	7317	44	8145	33
1182	85	1359	49	5018	75	5230	52	6006	73	6755	75	7119	12	7318	44	8146	56
1183	85	1360	81	5021	63	5235	54	6010	73	6756	75	7120	12	7319	44	8147	57
1184	85	1364	85	5025	65	5236	65	6019	73	6781	75	7121	12	7320	44	8160	18
1185	93	1365	85	5026	65	5240	52	6024	73	7005	31	712					



# Windsor

ARCHITECTURAL HARDWARE

## Backset

Distance from front edge of the door to the centre of the handle spindle hole.

## Cylinder

A key barrel that is inserted through a mortice lock to drive the locking function. These can be keyed alike to have the same key throughout the house.

## Desprung

Refers to a lock body or handle that has had the springing tension reduced or removed.

## Dummy Mount

Small plate with a fixed spindle mounted to it to be used under a dummy handle to prevent it operating on the door.

## Escutcheons

The housing or decorative plates that are mounted to a door around a cylinder or keyhole to cover up holes made in a door.

## Grub screw

Screw that tightens the handle to the spindle.

## Lever

Refers to the handle part that you grip with your hand.

## Mortice Lock

The lock body that is inserted into the door, includes both the locking and latching functions in one.

## Rebate Kit

A packer and striker system used between double doors at the point where the latch connects.

## Rose

Refers to the backplate part the handle mounts to. This encases the springs and point where the screws fix through.

## Auxiliary Privacy Bolt

Refers to the privacy style where there is a separate turn and release set mounted above or below the handles on the door.

## Spindle

The shaft that connects to each other through the door between the handles and drives the latch/lock mechanism.

## Striker

Plate mounted in the door jamb that the door latch closes against.

## Thru-fixing

Screw fixing that bolt through the door binding the two handles together.

## Tubular Latch

Refers to a tubular mechanism that is inserted in the door. This is the part that the handles operate to open and close the door.

## Passage Set

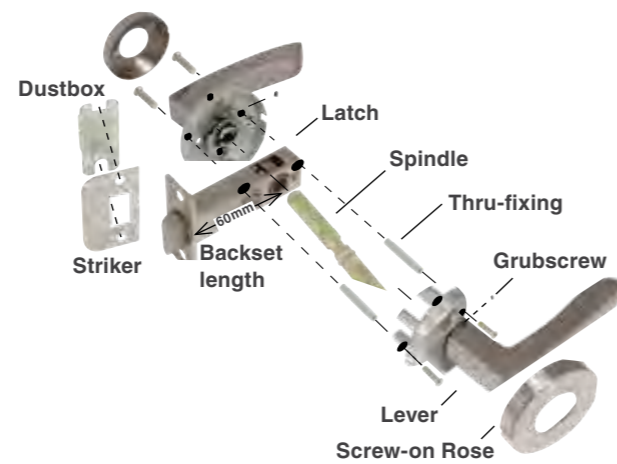

## Integrated Privacy Set

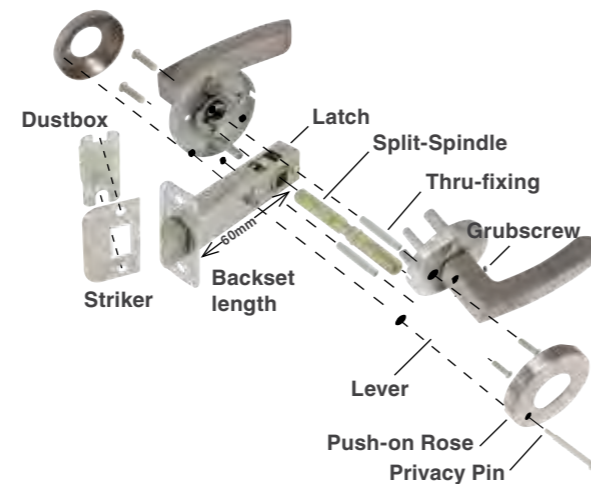

## Locking Set

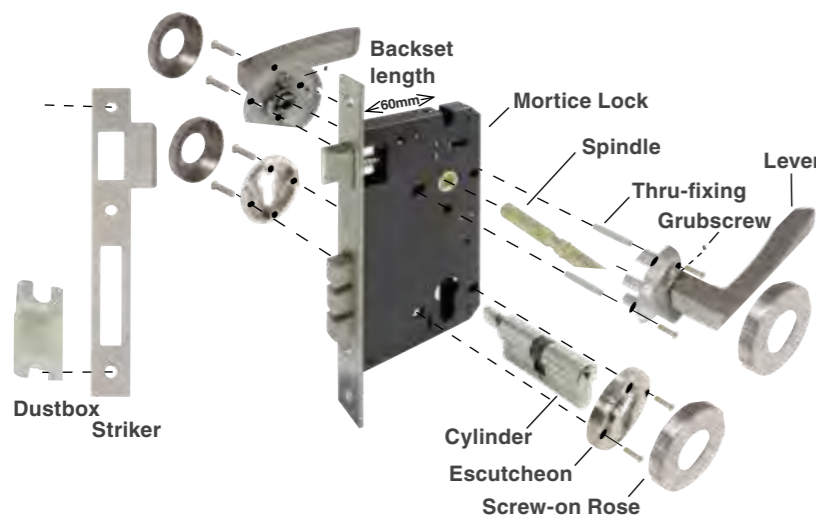

## Auxiliary Privacy Bolt

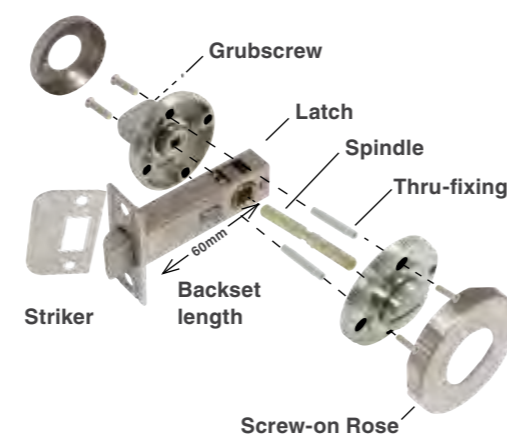

windsorbrass.co.nz

Windsor Brass Ltd  
**New Zealand**  
 PO Box 1595, 42-48 Arena Avenue  
 Invercargill, 9840  
 T +64 3 214 0060  
 F +64 3 214 0070  
 E sales@windsorbrass.co.nz  
 W www.windsorbrass.co.nz

## Australia

Sydney  
 T +61 2 8011 1833  
 Melbourne  
 T +61 3 9111 0342  
 E sales@windsorbrass.com.au  
 W www.windsorbrass.com.au

*Printed using environmentally friendly inks and paper from sustainably managed forests.*

*Products and specifications are subject to change without notice.*