

900mm Polo Pull Handles

Product codes: 7101

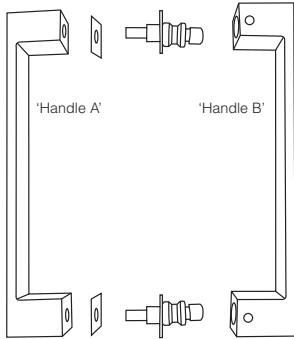

1. Take the pull handle apart by unscrewing the grub screws on both legs and then unscrewing the bolts with a 5mm allen key.

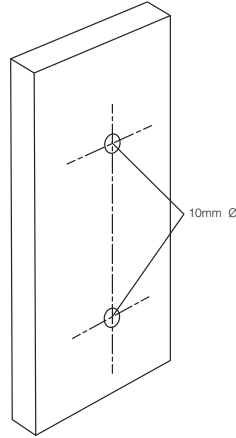
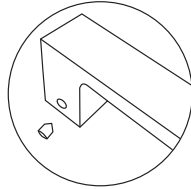

2. Mark the fixing position for the pull handle on the door. Ensure adequate space is provided for clearance of knuckles on the door jamb.
3. Drill two 10mm diameter holes at vertical positions for the leg centres at 860mm crs.

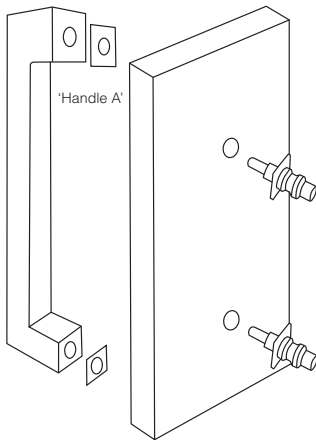

4. Screw the bolts through the door into 'Handle A' and tighten them.

Note: Use the long bolts provided for timber doors or the short bolts for glass doors. Only use the plastic sleeves and washers for glass doors.

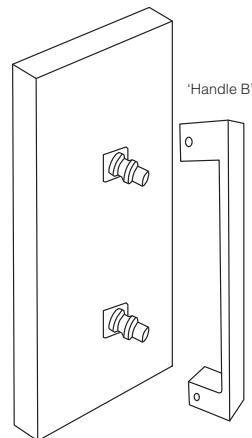

5. Insert 'Handle B' onto the brass mounts and secure it with the grub screws.