

### NIDO ROUND ROSE LEVER SET

#### Product codes:

8401 | 8411 | 8421 | 8431 | 8441

To view an easy to follow how-to video for installing this product visit [windsorhardware.co.nz/installation](http://windsorhardware.co.nz/installation).

Nido Lever Sets are typically used on double doors without a latch. If used with a mortice lock refer to mortice lock instructions.

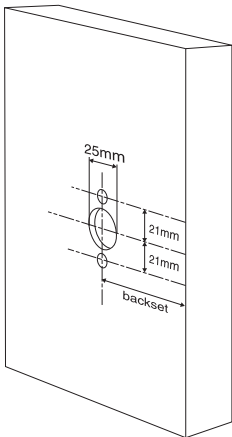

1. Establish the height and position for the handles on the door.
2. Mark the face of the door each side for drilling a 25mm diameter spindle hole. Match the backset measurement of the passage doors throughout your home. Mark two screw holes at 21mm above and below the centre of the spindle hole. Drill the screw holes to 7mm to accept the threaded sleeves. For clean cut-outs, drill from both sides, meeting in the middle of the door.

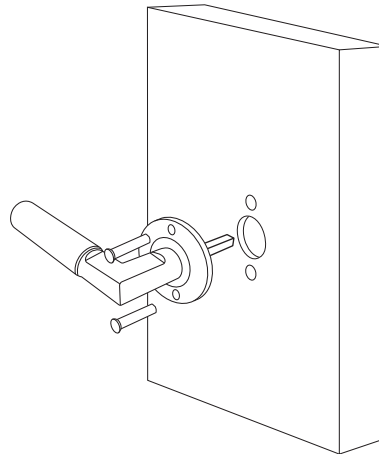

3. Insert the spindle into the the handle. Ensure the grooved side of the spindle will align with the grubscrews on the handles.
4. Choose either the blank or Philips head short through fixing bolts and insert those into the threaded sleeves (1). Then insert those sleeves through the face of the round rose. Insert the handle with the spindle attached into the spindle hole and press against the door.

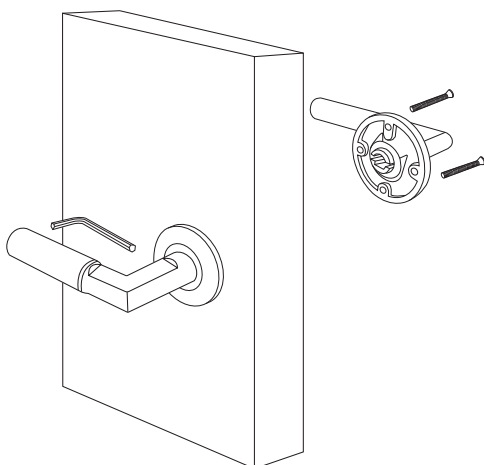
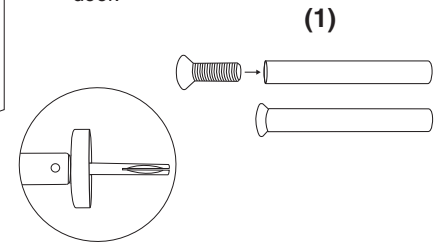

5. Slide the handle on the opposite side of the door over the spindle and press against the door. Insert the long bolts through the face of the round rose and tighten them into the threaded sleeves.
6. Screw the rose covers onto the handles and tighten the grubscrews on the side of the levers onto the spindle for each side of the door.

*Note: The grubscrews may need a re-tighten after a bedding-in period. We recommend medium strength thread-lock to be used, Windsor code: 1276*