

Chalet

Crisp and clean lines, with a distinctively European feel. An effortlessly stylish and slim design with radiused edges where a minimalistic look is desired.

Small Rose

8211 Lever Set	8217 Privacy Set - Separate*
8211D Dummy Lever	8218 E48 Entrance Set
8212 Passage Set*	8219 E85 Entrance Set

- > **Lever Set**
Includes Levers only
- > **Dummy Lever**
Includes single Lever and 1152 Dummy Mount
- > **Passage Set***
Includes Levers and 1172 Tubular Latch - 57mm b/s
- > **Privacy Set – Separate***
Includes Levers, 1172 Tubular Latch, 1173 Tubular Bolt and 8188 Privacy Turn & Release - 57mm b/s
- > **Entrance Set E48**
Includes Levers, 1115 Euro Mortice Lock, 1148 Euro Cylinder & Turn and 8189 Euro Escutcheons - 57mm b/s
- > **Entrance Set E85**
Includes Levers, 1403 or 1143 Euro Mortice Lock (finish dependent), 1148 Euro Cylinder & Turn and 8189 Euro Escutcheons - 60mm b/s

* Available with standard or magnetic latches. To upgrade any passage or separate privacy (auxiliary) set to magnetic latches simply add an 'M' to the end of the existing 4 digit code.

ITALIAN



Dimensions

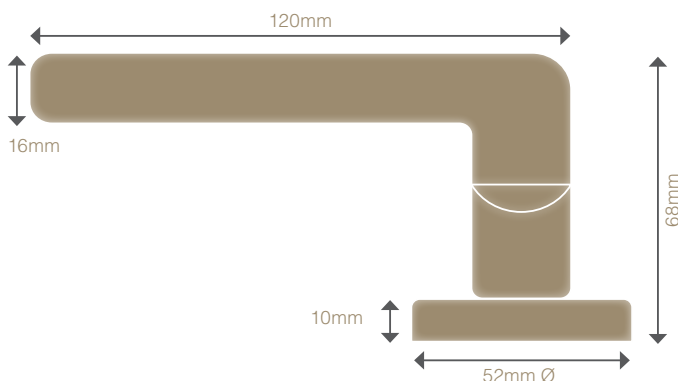
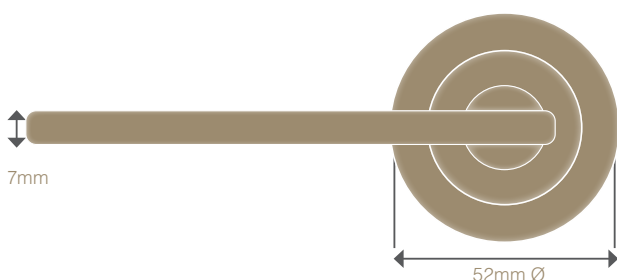

Specs

- > Constructed from solid brass
- > Suits door thicknesses of 30–50mm
- > For door thicknesses that exceed this, custom spindles and alternative fixings will need to be sourced
- > Suitable for interior and exterior use (advise application on order)
- > For external applications we recommend selecting a living finish that will age gracefully over time instead of a lacquered finish that may tarnish if it gets badly scratched or damaged.

Installation

- > 57mm backset (see diagram) or 60mm backset for magnetic latches
- > 42mm screw centres — Thru fixing supplied
- > Passage Set installation shown
- > Inside hole can be 22–25mm diameter
- > Through screw holes can be drilled at 3 & 9 o'clock **OR** 12 & 6 o'clock positions.

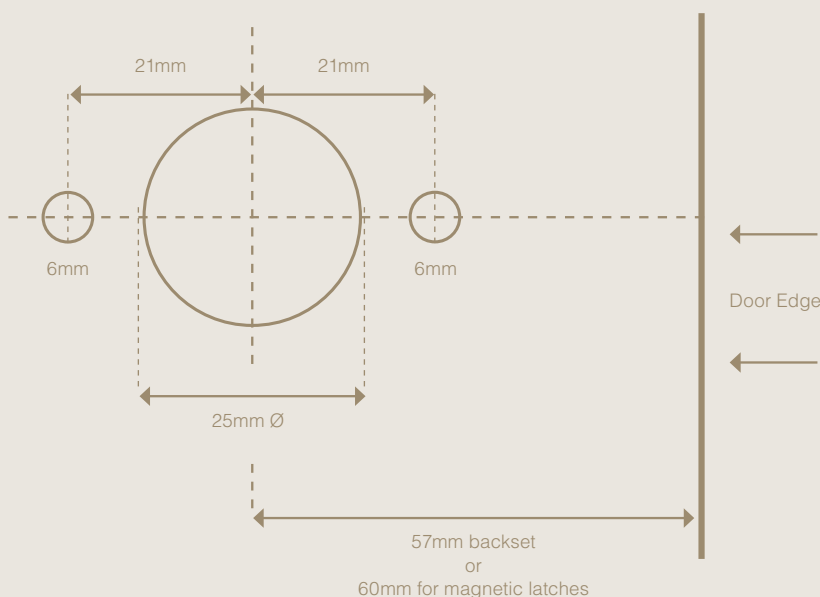
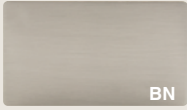

Diagram is not to scale, please refer to fitting instructions [here](#).

Finishes

Stocked



BN

Brushed Nickel

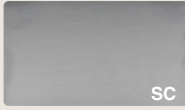

SC

Satin Chrome

Living

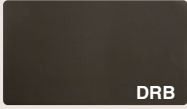

DRB

Dark Roman Brass

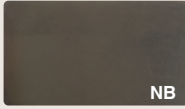

NB

Natural Bronze

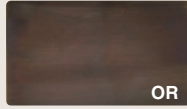

OR

Oil Rubbed Bronze



RB

Roman Brass



RLB

Rumbled Brass

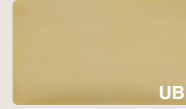

UB

Unlacquered Brass

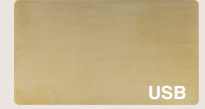

USB

Unlacquered Satin Brass

Lacquered

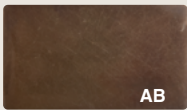

AB

Antique Bronze

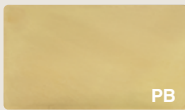

PB

Polished Brass

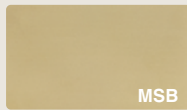

MSB

Matt Satin Brass

Matt Lacquered

Powdercoat

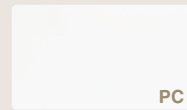

PC

Powdercoat

> Colours are from the Dulux range

To view this handle style in each finish option, visit our [website](#) and enter any product code listed on page 1 of this document.

Care & Maintenance

Stocked Finishes

To protect your handles we suggest cleaning the surface of your hardware periodically with a warm soapy lightly dampened cloth to remove any build-up of dust and grime that may cause corrosion and affect the integrity of the finish. Then simply dry thoroughly with a clean, soft cloth. Minimum of monthly cleaning of door handles is recommended for both finish preservation and general hygiene.

Atmospheric conditions, salt deposits, acids, caustic agents, cement or dust on construction sites all have the potential to cause discolouration to the surface.

Please avoid using any metal polishes, abrasive cleaners, scorers or rough cloths that may damage or scratch the hardware and do not spray or immerse the hardware in liquid to clean.

Living Finishes

The living finishes will naturally patina over time with general use. As with all living and aging finishes, it is recommended to clean the surface periodically with a damp soapy cloth to remove any build up of dust and grime that may cause corrosion and affect the integrity of the finish.

Unlacquered Brass can be further protected by using the Windsor wax polish occasionally, rubbing this lightly over the surface will provide a layer of protection for extended finish longevity.

Oil Rubbed Bronze, Roman Brass and Dark Roman Brass can be preserved by gently applying a thin oil layer to the surface from time to time. Wipe a thin layer of olive oil (or similar) over the handle then with a clean cloth wipe again to remove any excess on the surface.

Lacquered Finishes

The finishes with a lacquer are recommended to be kept free of dust and grime to prevent any chance of these particles affecting the integrity of the lacquer and potentially causing breakdown or discolouration. We suggest these are wiped and cleaned periodically using a mild window cleaner and damp cloth.

Gloss Lacquered finishes may get some light surface scratches appearing with normal wear and tear, for this we recommend using the Windsor wax polish occasionally, rubbing this lightly over the affected area to will provide a layer of protection for extended finish longevity.

We do not recommend Lacquered Finishes to be used externally as if badly scratched or damaged tarnishing can occur.