

ITALIAN LONGPLATE PASSAGE SET

Recommended latch code 1172

Product codes:

8168	8169	8194	8195	8171	8172
8205	8215	8225	8233	8234	

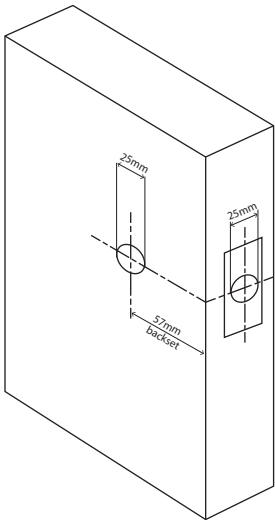

1. Measure the door thickness and mark the centre at the desired height for the latch.
2. Drill a 25mm (1") diameter hole through the door edge to a depth of at least 80mm. Ensure this hole is square to the door.
3. Mark the face of the door each side for drilling a 25mm diameter spindle hole. The centre of the spindle hole will need to be 57mm from the door edge (backset). For clean cut-outs, drill from both sides, meeting in the middle of the door.

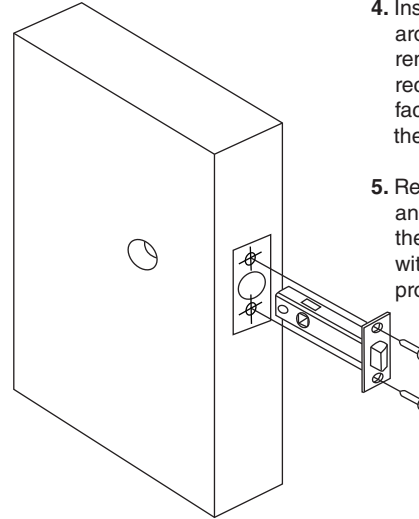

4. Insert the latch, scribe around the faceplate, remove, then chisel out recess to enable the latch faceplate to sit flush with the door edge.
5. Remove any loose saw dust and insert the latch, attach the faceplate and secure with the wood screws provided.

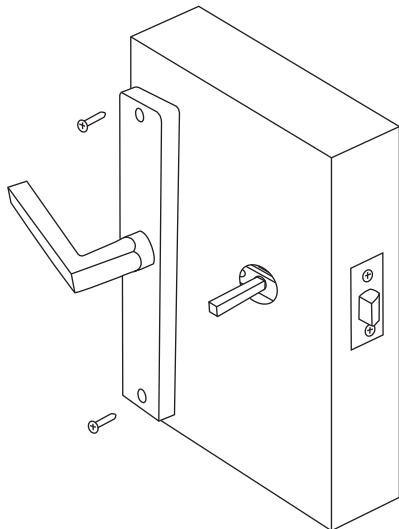

6. Insert the spindle into the latch so an even amount protrudes on each side of the door.
7. Insert the handle over the spindle and ensure the grooved side of the spindle is aligned with the grub screws on the handles. Ensure the longplate is straight before securing with the wood screws provided.

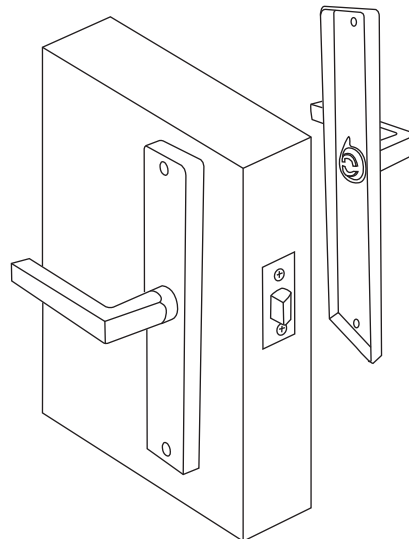

8. Insert the handle on the opposite side of the door over the spindle, ensure it is straight and secure with the wood screws provided.
9. Tighten the grub screws on the side of the levers onto the spindle for each side of the door.

Note: The grub screws may need a re-tighten after a bedding-in period. We recommend medium strength thread-lock to be used, Windsor code: 1276

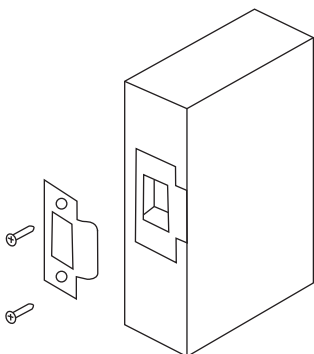

10. Close the door against the frame and mark the latch position for fitting of the striker.
11. Router or chisel so the striker fits flush, allowing for the plastic dustbox behind the striker.
12. Secure the striker with the wood screws provided. Test the door and if necessary, adjust the striker anti-rattle tab to take up any rattle.